

Golden-Cheeked Warbler

Conservation Status: Endangered



Golden-Cheeked Warbler

Setophaga chrysoparia

Endangered

EN

The Golden-Cheeked Warbler is an endangered bird that nests primarily in Juniper-Oak woodlands. With striking yellow and black plumage, the Golden-Cheeked Warbler is the only bird species whose population nests exclusively in the state of Texas.



Conservation: Many Golden-Cheeked Warbler habitats have been destroyed due to construction and agriculture. In addition, Juniper trees, their primary nesting place, have been dwindling in number. The U.S. Fish & Wildlife Service is currently creating protected areas for the Golden-Cheeked Warbler to live.



Habitat

Woodlands

Diet

Various insects

Nesting

Juniper trees

Did you know: The Golden-Cheeked Warbler was first discovered around 1860 in Guatemala. However; their nesting grounds in Texas were not discovered for another four years.

Florida Scrub-Jay

Conservation Status: Vulnerable



Florida Scrub-Jay

Aphelocoma coerulescens

Vulnerable

VU

The Florida Scrub-Jay is a social, ground-foraging bird that lives exclusively in Florida. Primarily found in the low-growing scrublands of Central Florida, the Florida Scrub-Jay is omnivorous and eats a wide variety of nuts, insects, mice, and other small wildlife.



Conservation: The Florida Scrub-Jay's habitat has dwindled significantly over the past few decades due to climate change and habitat fragmentation. Based on recent studies, it is estimated that only 4,000 - 8,000 Florida Scrub-Jays are left in the wild.



Habitat

Florida Scrublands

Diet

Omnivore

Nesting

Trees

Did you know: The oldest recorded Florida Scrub-Jay was nearly 15 years old when it was documented in 1990.

Piping Plover

Conservation Status: Near Threatened



Piping Plover

Charadrius melodus

Near Threatened

NT

The Piping Plover is a small shorebird that lives in coastal regions and barrier islands in North America. With a sharp black collar and orange bill, these lively birds nest farther up on the beach away from the water's edge, and feed primarily on insects, worms, and crustaceans.

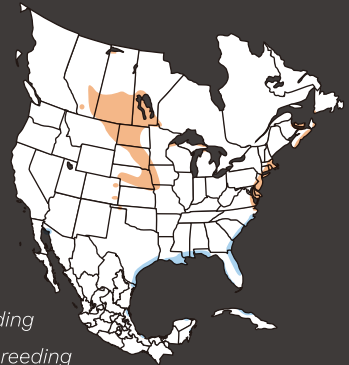

Conservation: The Piping Plover is globally threatened and has become uncommon in its typical ranges. Their total population is estimated to be only 7,000-9,000 individuals. Currently, there are several ongoing conservation efforts, including beach closures in known nesting areas during breeding season.



Habitat

Shorelines

Diet

Insects, Crustaceans

Nesting

Sandy beaches

Did you know: Even though they travel hundreds of miles between their winter and summer breeding sites, most Piping Plovers return to nearly the exact same nesting location each time.

金颊莺

保护状态：濒危



金颊莺

Golden-Cheeked Warbler

濒危

EN

金颊莺是一种濒临灭绝的鸟类，主要在杜松橡树林地筑巢。金颊莺有着醒目的黄色和黑色羽毛，是唯一一种只在德克萨斯州筑巢的鸟类。



保护措施：许多金颊莺的栖息地因建筑和农业而遭到破坏。此外，它们的主要筑巢地杜松树的数量也在减少。美国鱼类和野生动物管理局目前正在为金颊莺建立保护区。



栖息地

兀兰

饮食

各种昆虫

筑巢地

杜松树

你知道吗：金颊莺于 1860 年左右在危地马拉首次被发现。然而，它们在德克萨斯州的筑巢地又过了四年才发现。

灌丛鸦

保护状态：易危



灌丛鸦

Florida Scrub-Jay

易危

VU

灌丛鸦是一种仅生活在佛罗里达的群居、地面觅食的鸟类。灌丛鸦主要生活在佛罗里达州中部的低矮灌木丛中，是杂食性动物。食物对象是各种各样的坚果、昆虫、老鼠和其他小型野生动物。

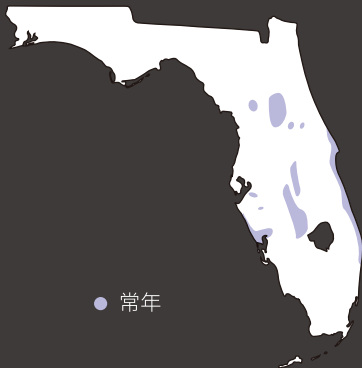

保护措施：由于气候变化和栖息地破碎化，在过去的几十年里，灌丛鸦的栖息地已显着减少。根据最近的研究，估计仅有 4,000 - 8,000 只灌丛鸦留在野外。



栖息地

佛罗里达灌木丛

饮食

杂食动物

筑巢地

树木

你知道吗：1990 年记录到的年龄最大的灌丛鸦是在 15 岁左右。

笛 鴿

保护状态:近危



笛鸻

Piping Plover

近危

NT

笛鸻是一种生活在北美沿海地区和障壁岛的小型鸻鹬。这些活泼的鸟有着锋利的黑色项圈和橙色的喙,在远离水边的海滩上筑巢,主要以昆虫、蠕虫和甲壳类动物为食。

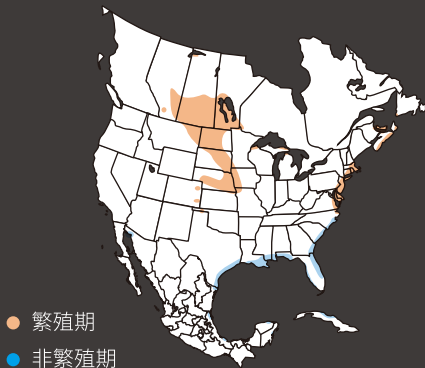

保护措施：笛鸻在全球范围内受到威胁，并且在常规栖息地变得不常见。它们总量估计仅有 7,000-9,000 只。目前，有几项正在进行的保护工作，包括在繁殖季节关闭已知筑巢区的海滩。



栖息地
海岸线

饮食
昆虫、甲壳类动物

筑巢地
沙滩

你知道吗：尽管它们在冬季和夏季繁殖地之间旅行数百英里，但大多数笛鸻每次都会返回几乎完全相同的筑巢位置。

1

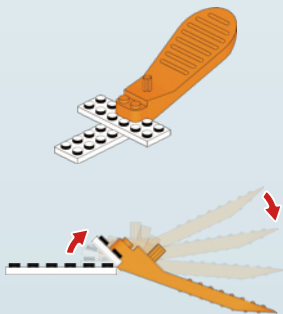

2

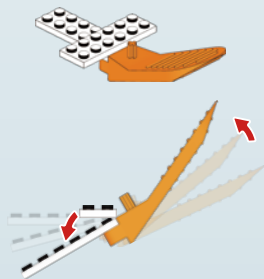

3

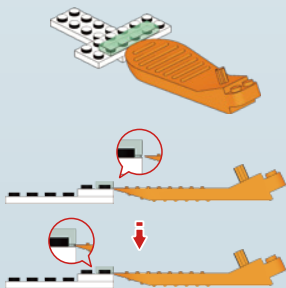

4

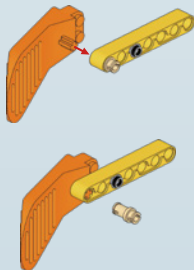

1

How the clip brick works!

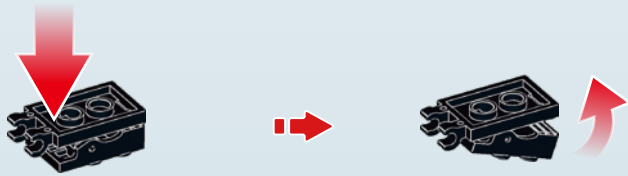

2

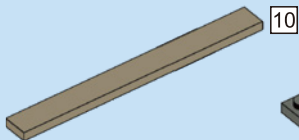
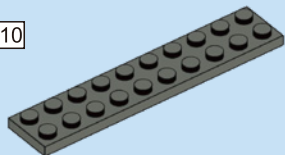
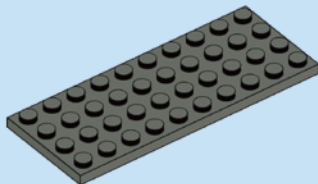
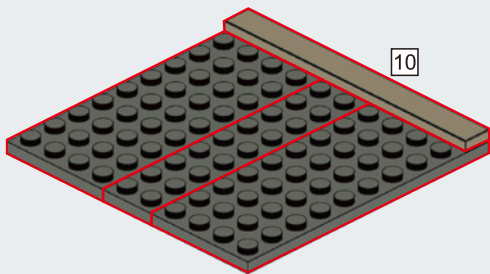

A**1x****1x****2x****A1****1**

C71025

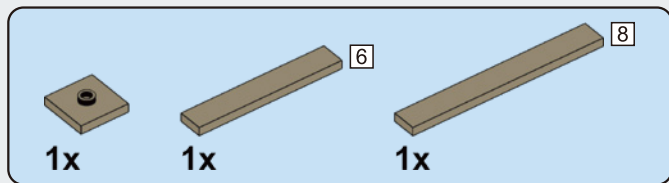

A2

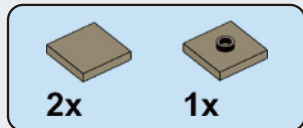
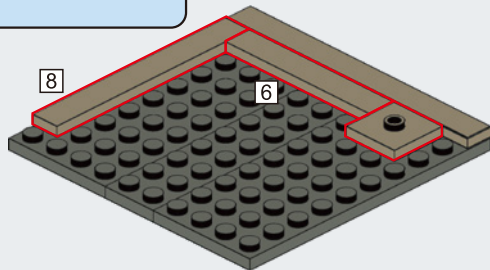

A3

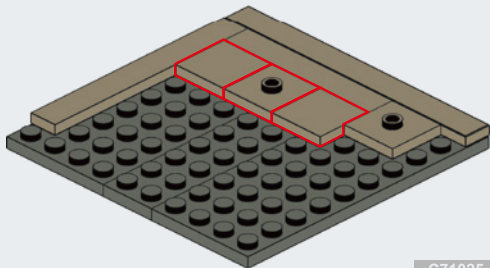

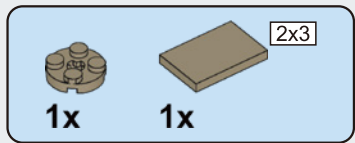

A4

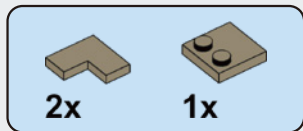
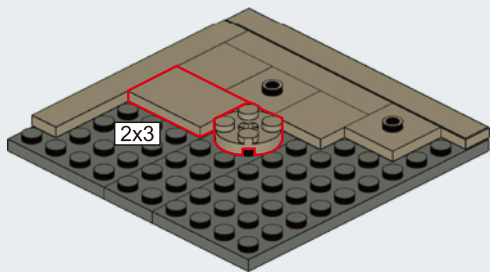

A5

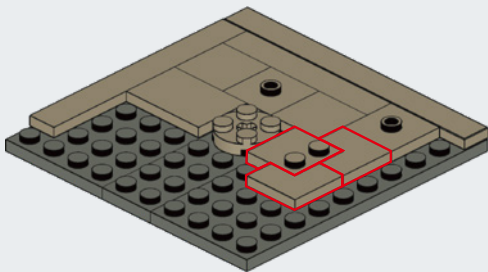

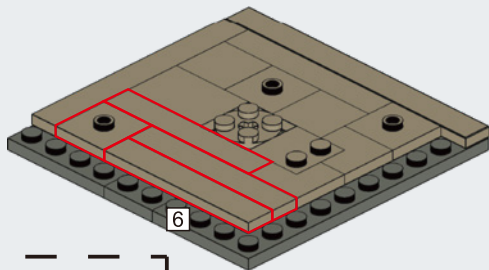
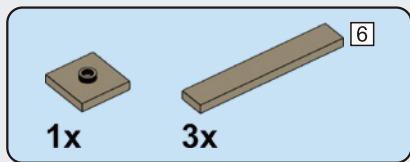

A6

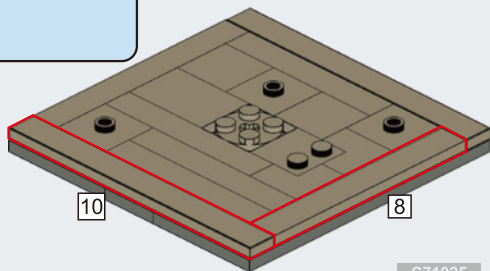
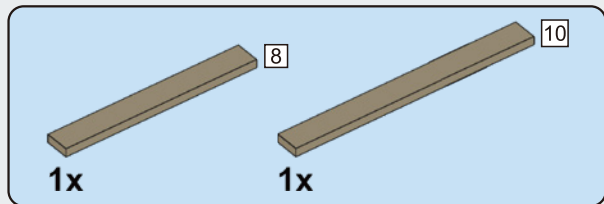

A7

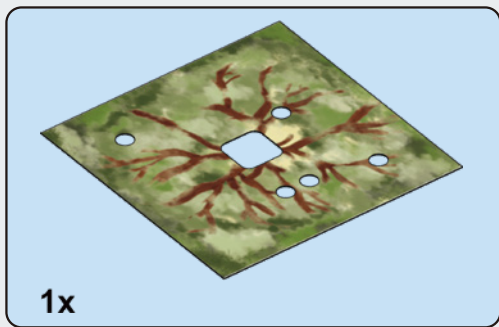

A8

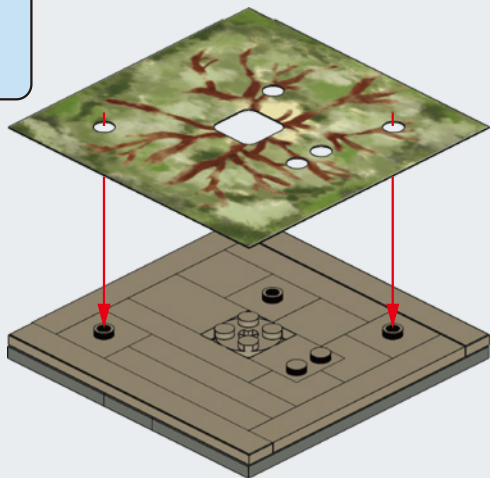



A9

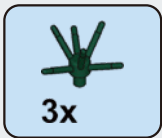
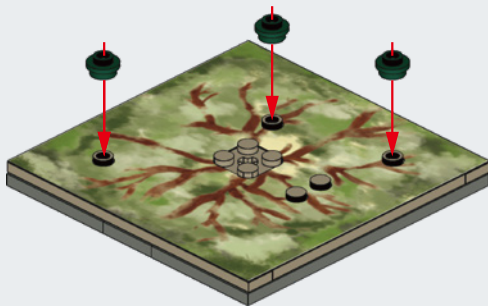

A10

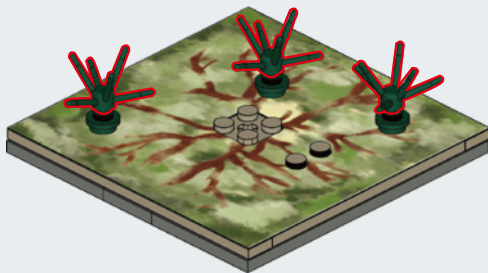

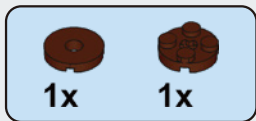

A11

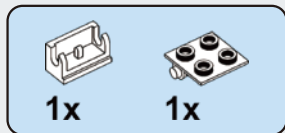
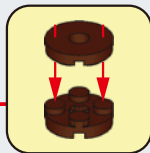
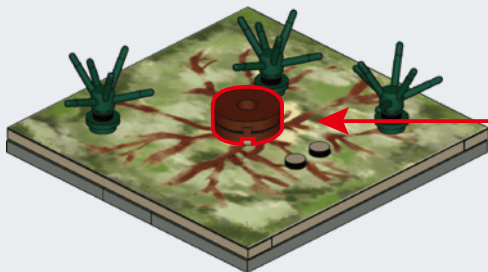

A12

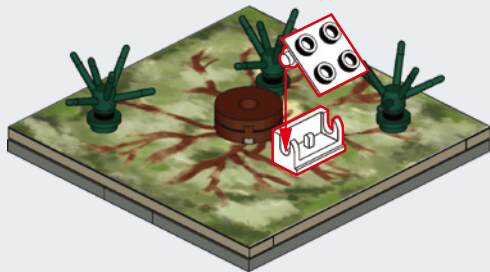

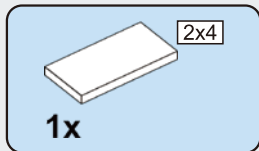

A13



A14

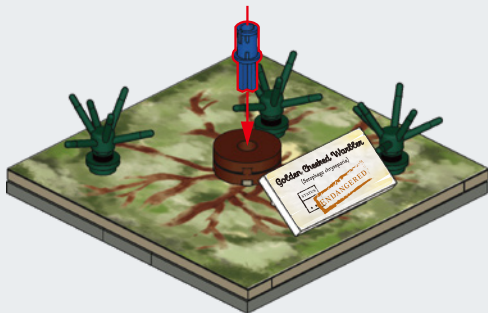

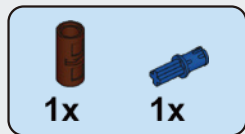

A15

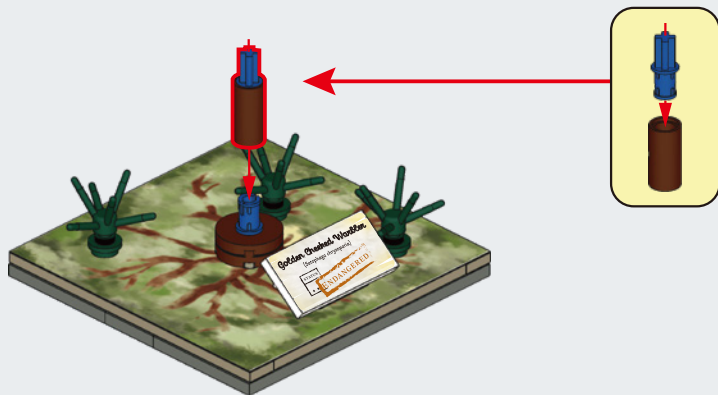

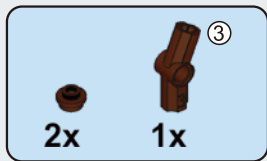

A16

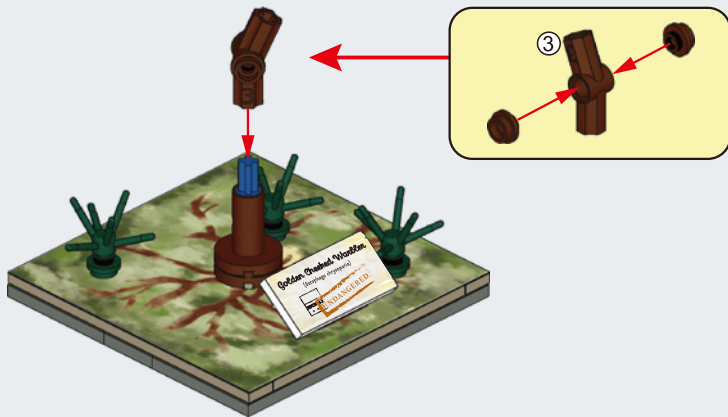

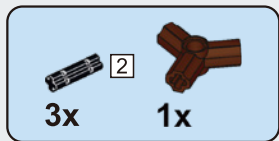

A17

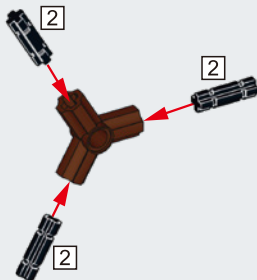

A18

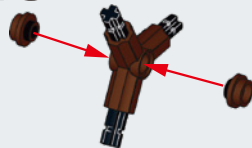

A19

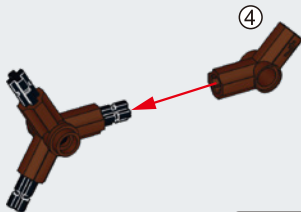

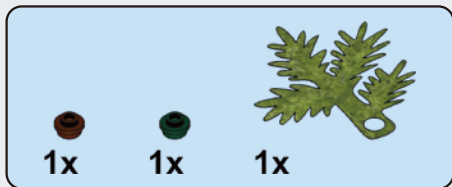

A20

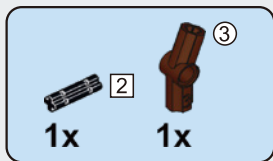
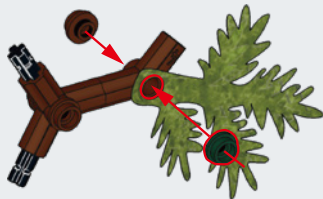

A21

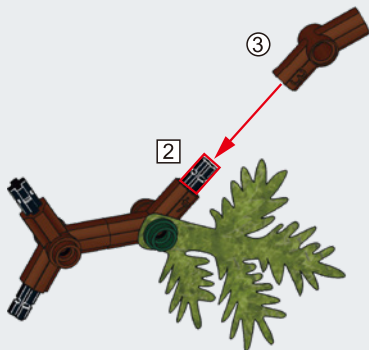

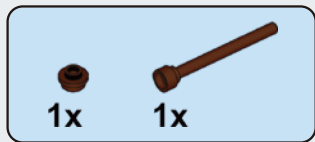

A22

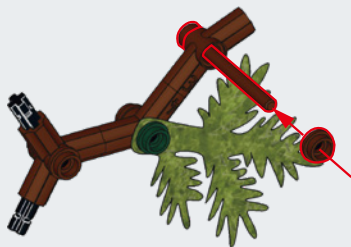

A23

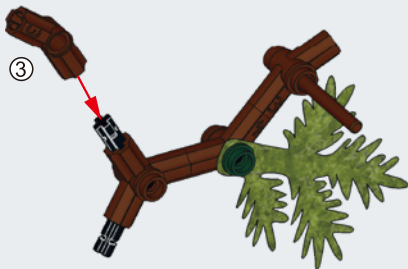

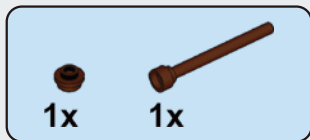

A24

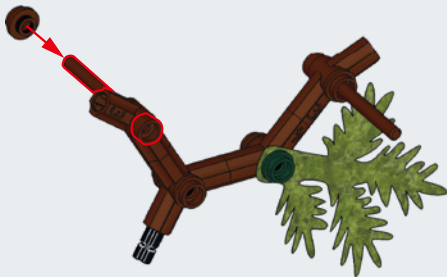

A25

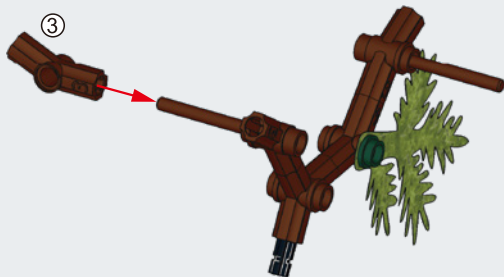

A26

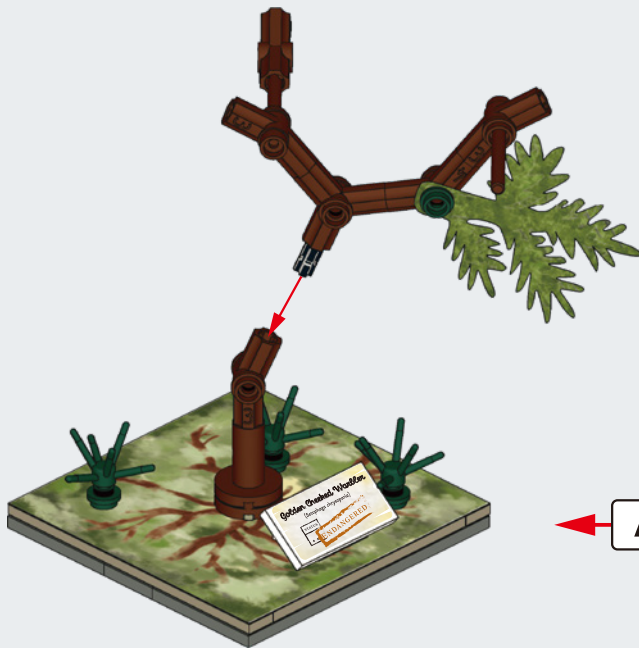

← **A16**

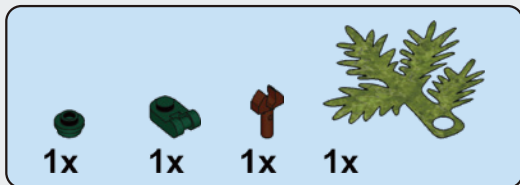

A27

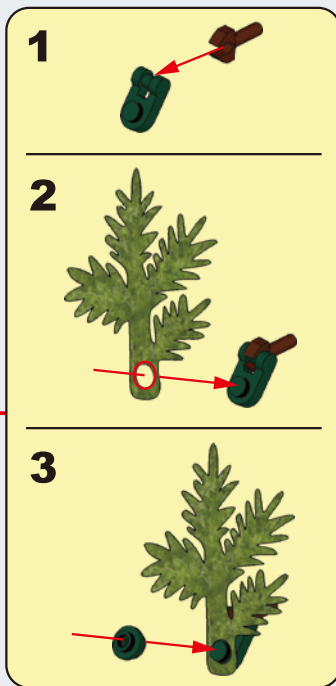
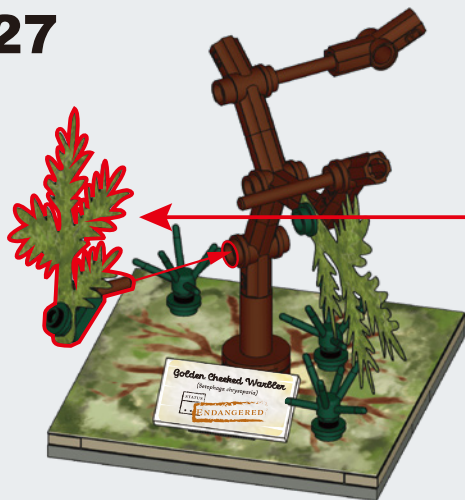

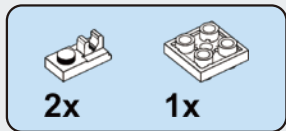

A28

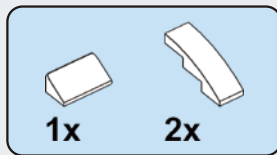
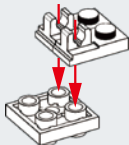

A29

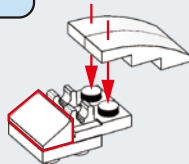

A30

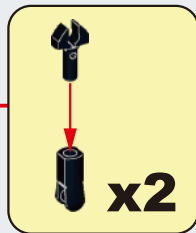
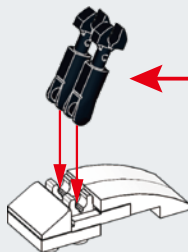

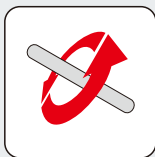
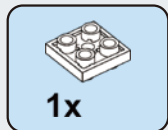

A31

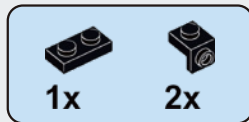
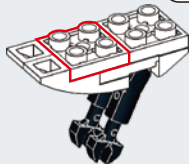

A32

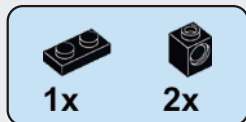
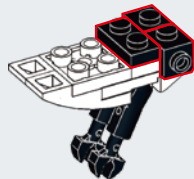

A33

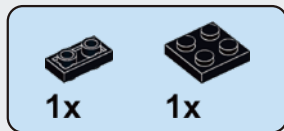
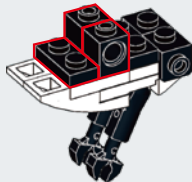

A34

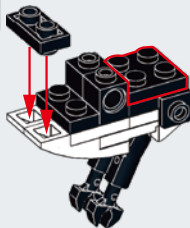

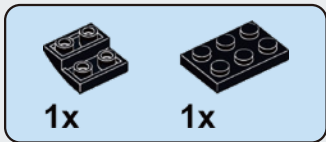

A35

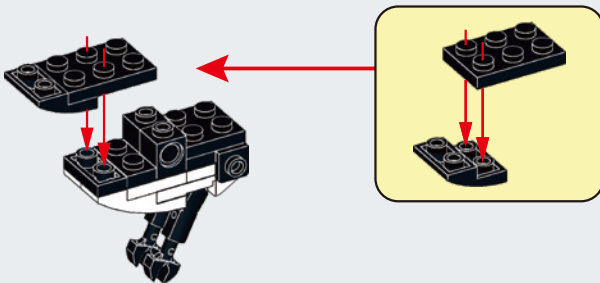

A36

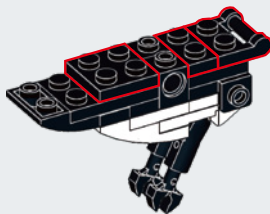

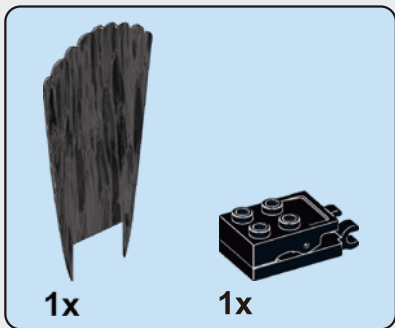

A37

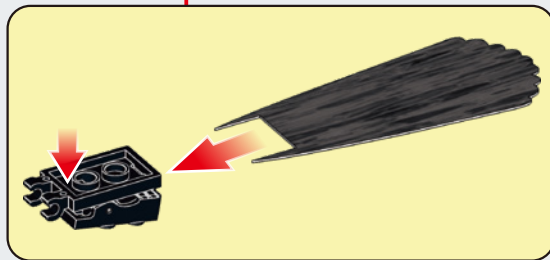
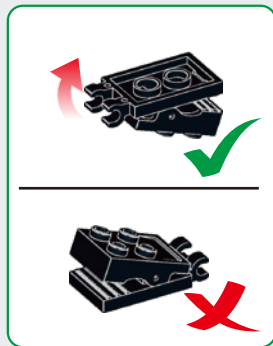
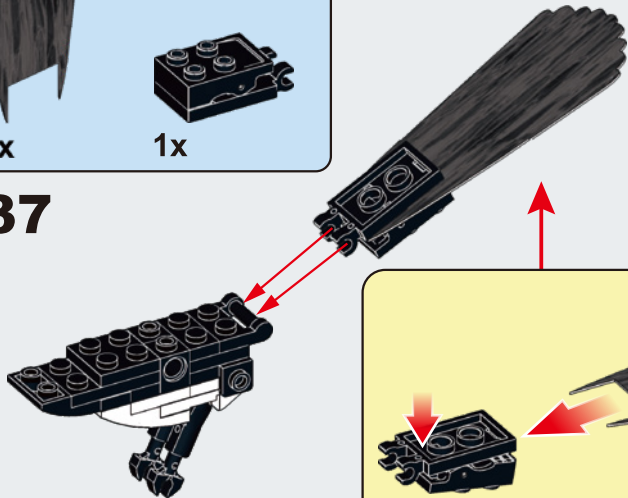

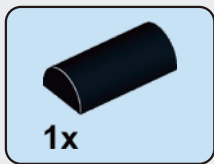

A38

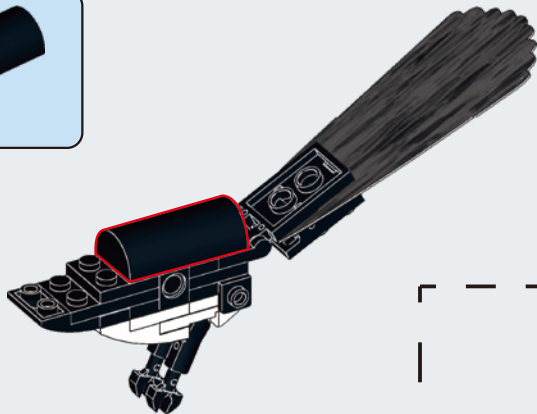

A39

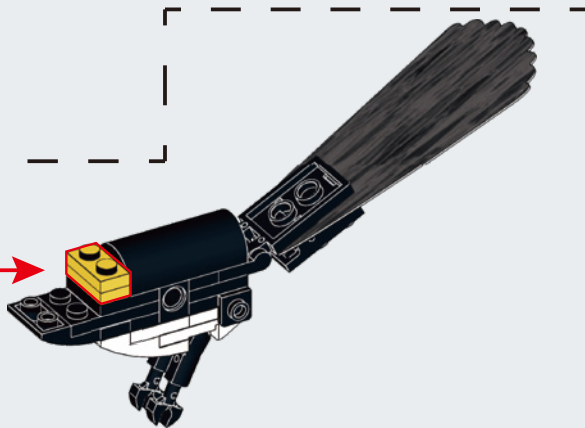
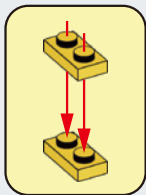

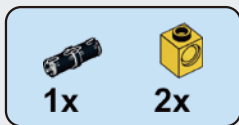

A40

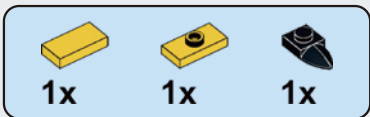
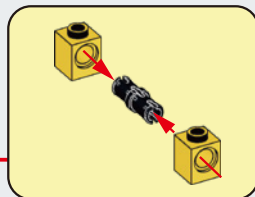
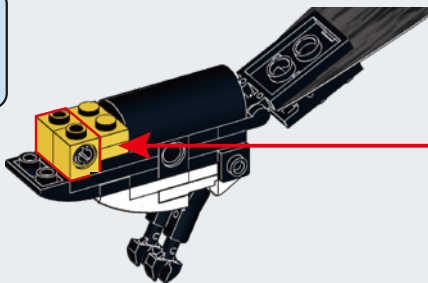

A41

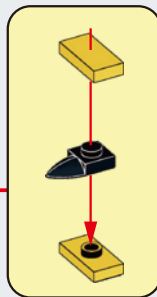
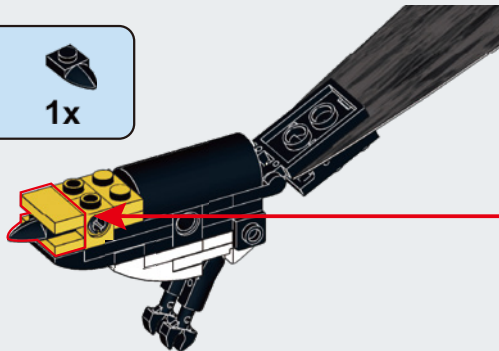



A42

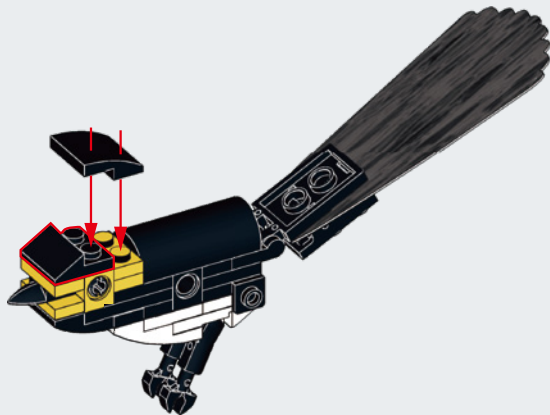



A43

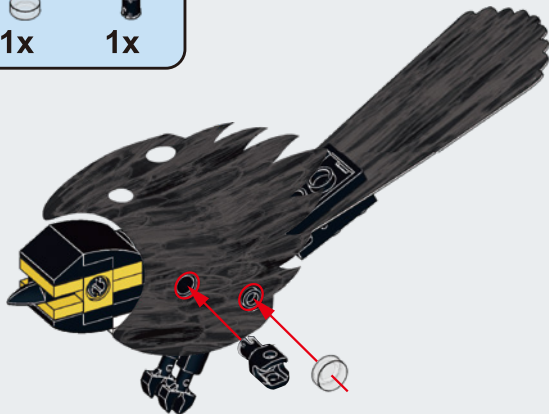

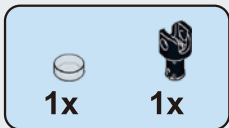

A44

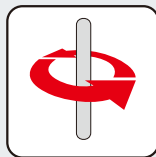



A45

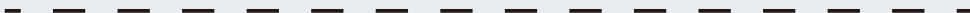
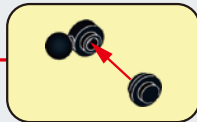
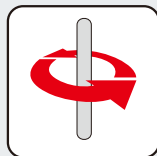

A46





A47

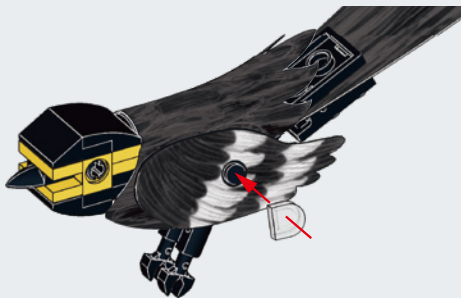

A48

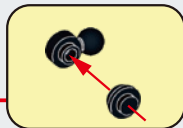
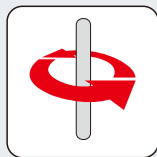
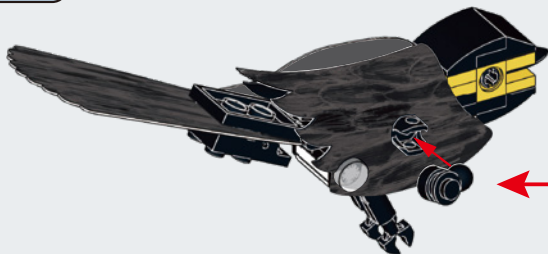



A49



A50

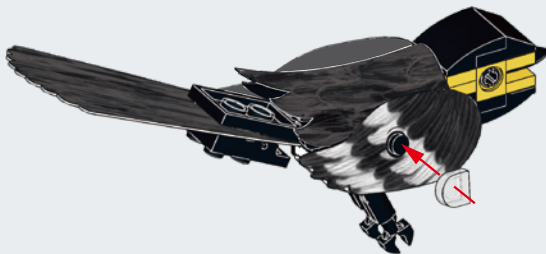

A51



A52

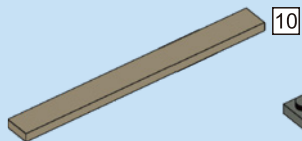
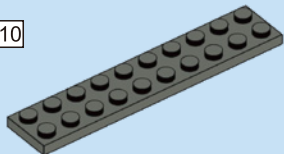
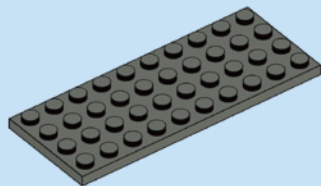
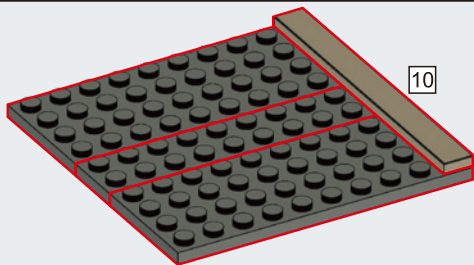

B**1x****1x****2x****B1**

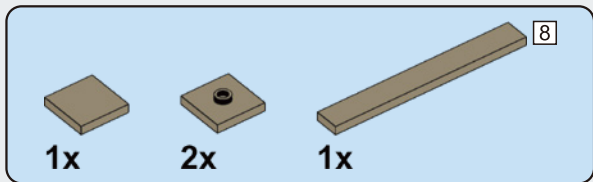

B2

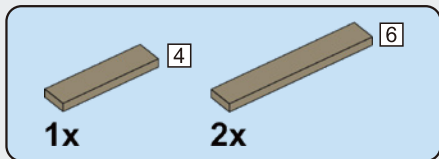
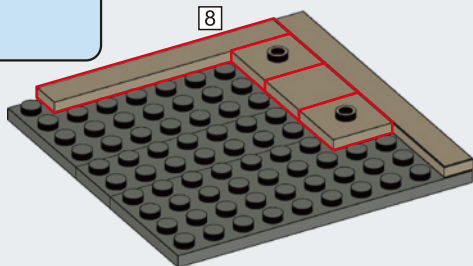

B3

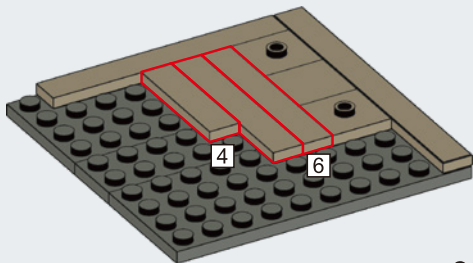

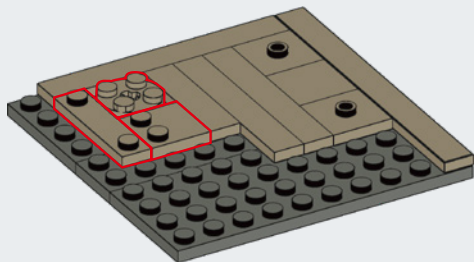
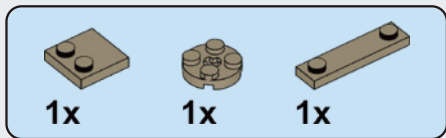

B4

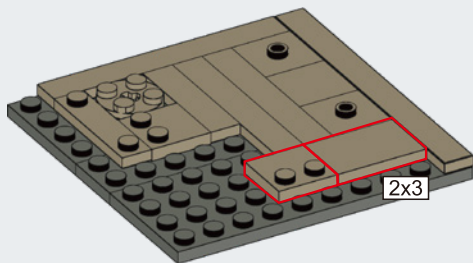
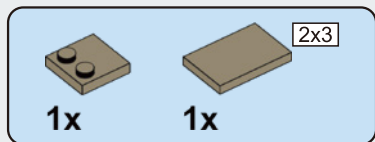

B5

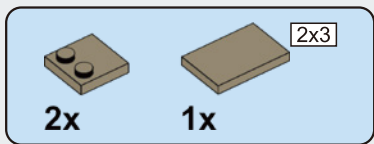

B6

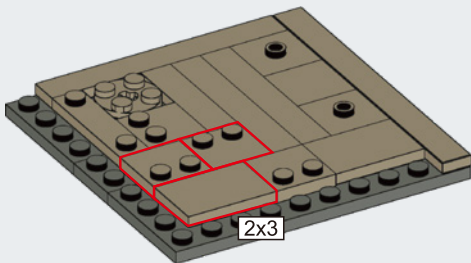

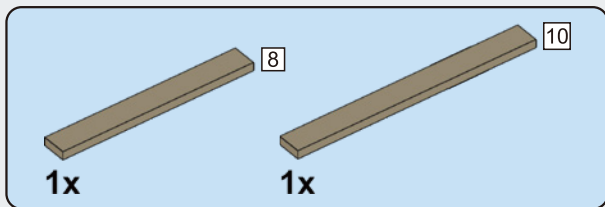

B7

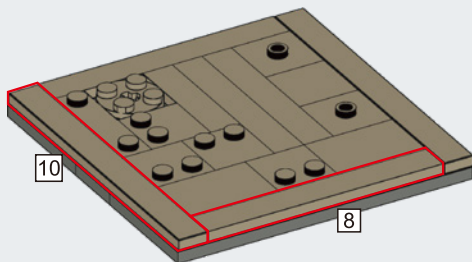

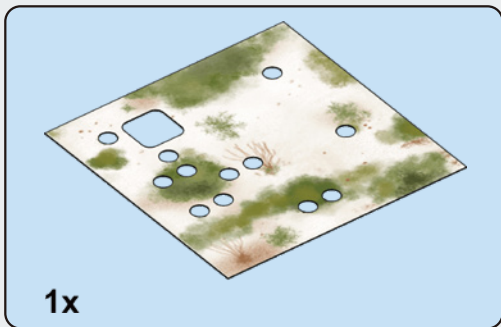

B8

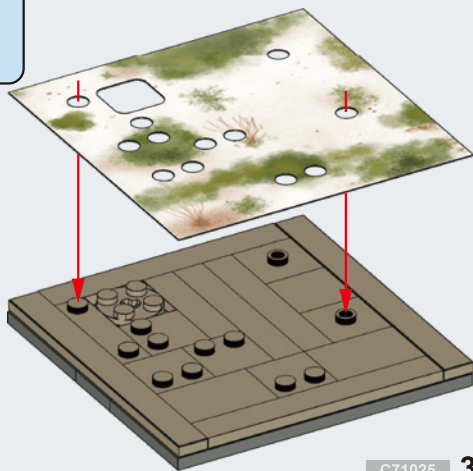



B9

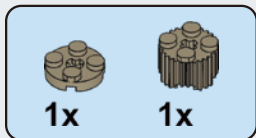
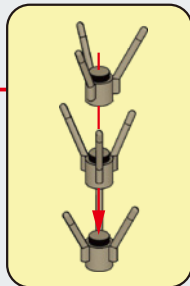
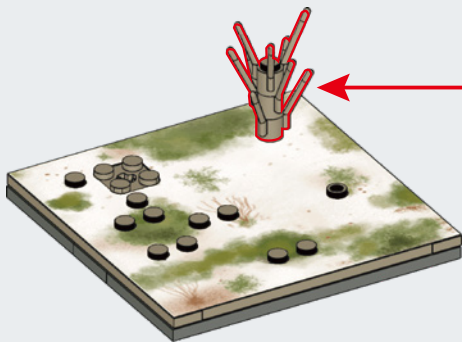

B10

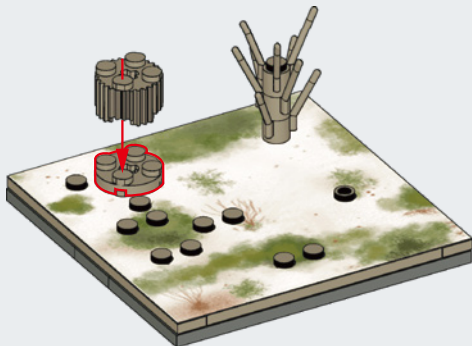

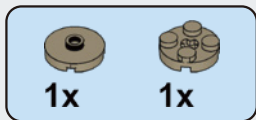

B11

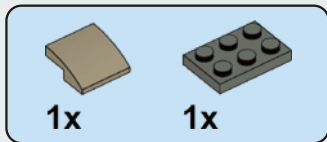
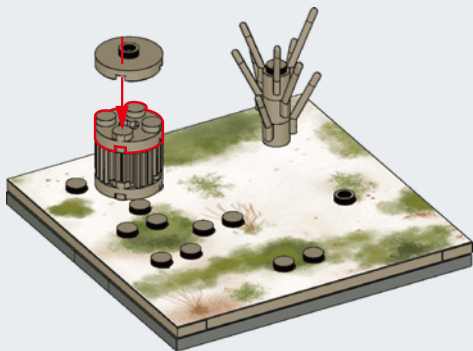

B12

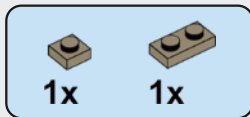
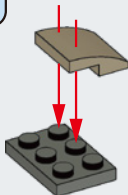

B13

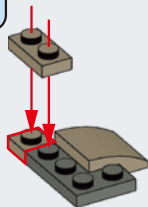

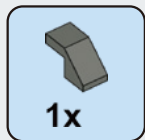

B14

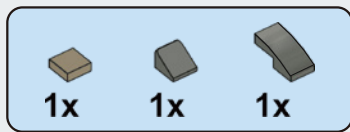
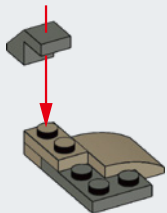

B15

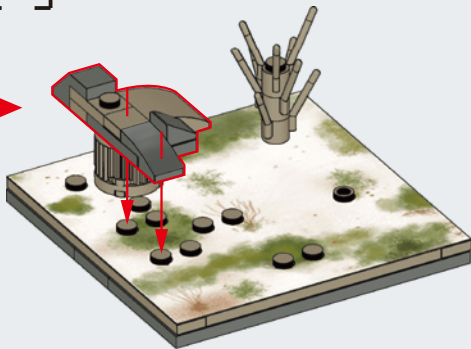
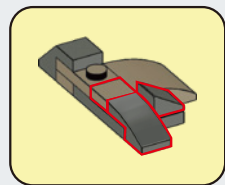

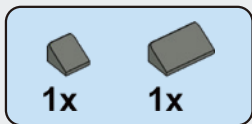

B16

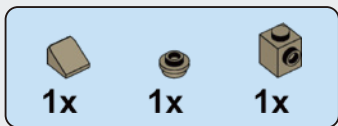
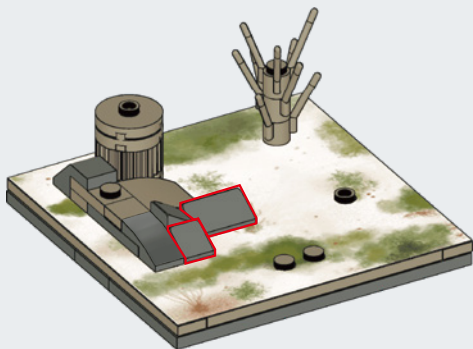

B17

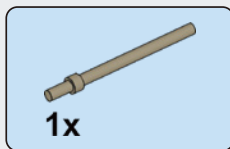
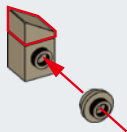

B18

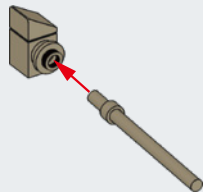

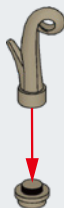
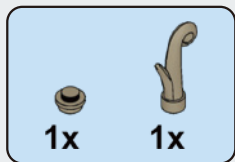

B19

B20

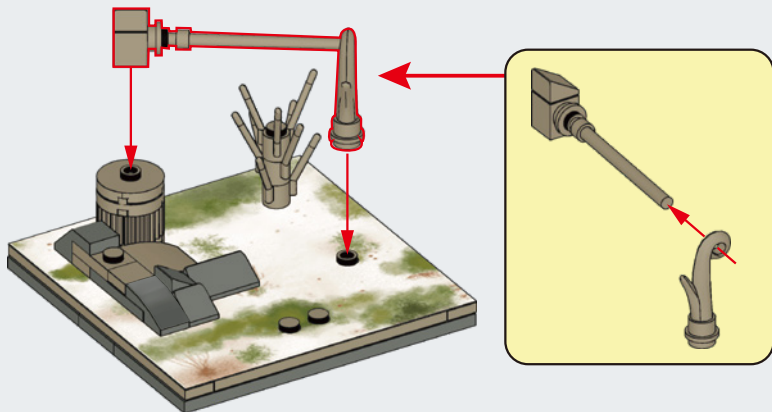

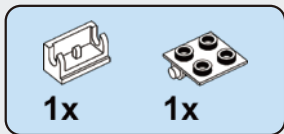

B21

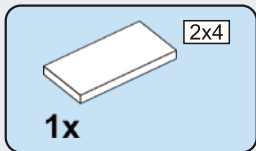
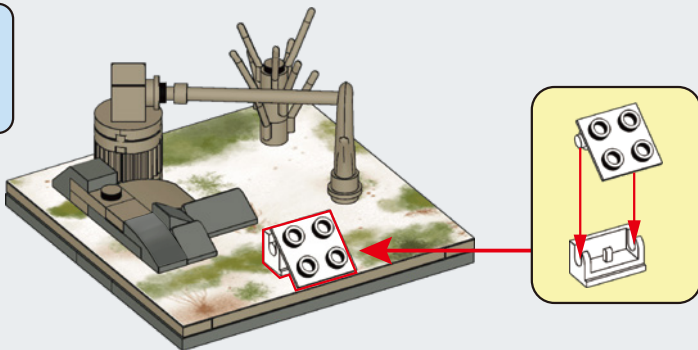

B22

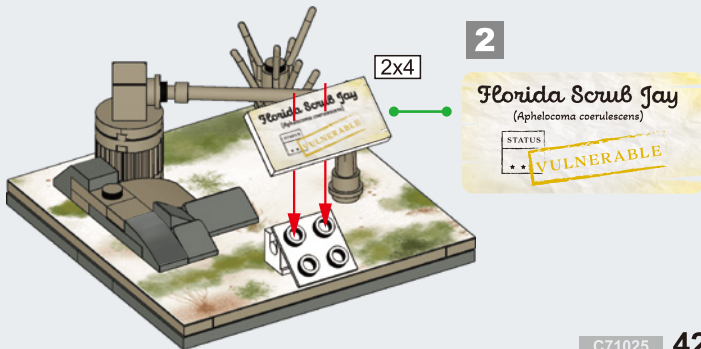



1x

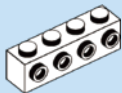

4x

B23

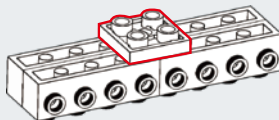

1x

B24

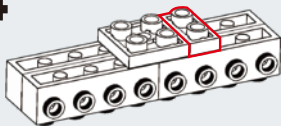

1x

B25

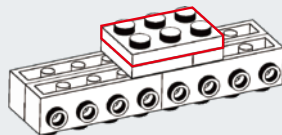

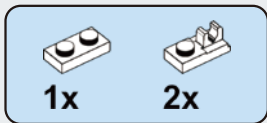

B26

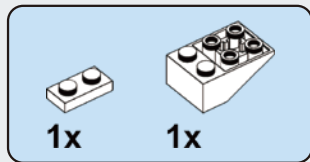
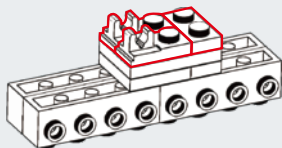

B27

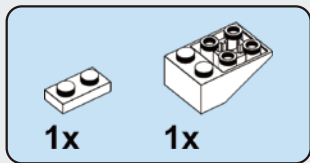
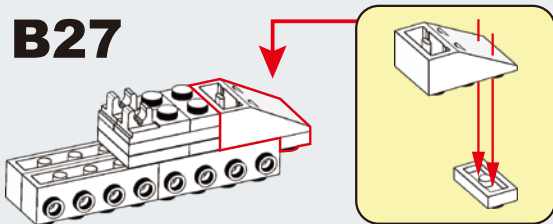

B28

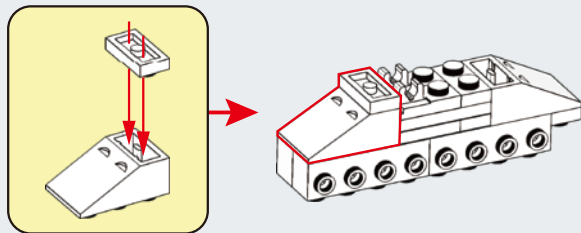

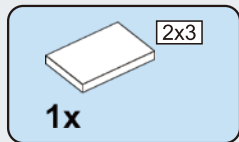

B29

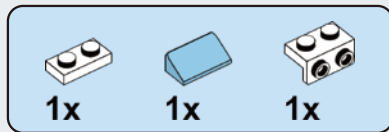
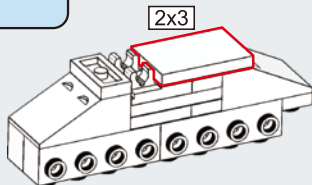

B31

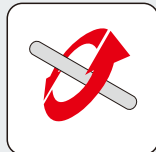

B30

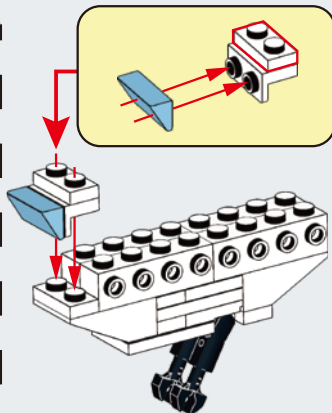
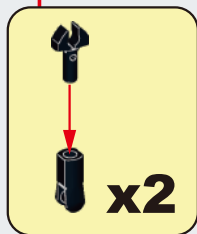
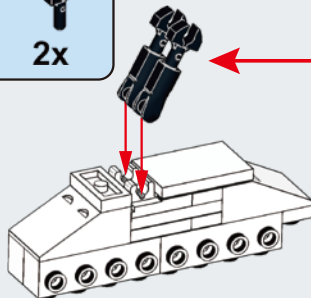

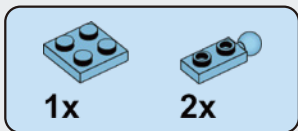

B32

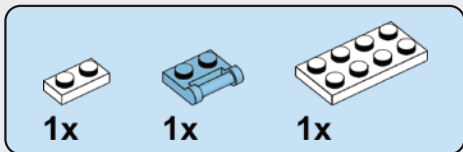
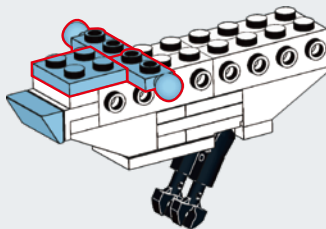

B33

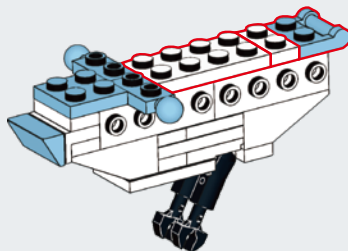

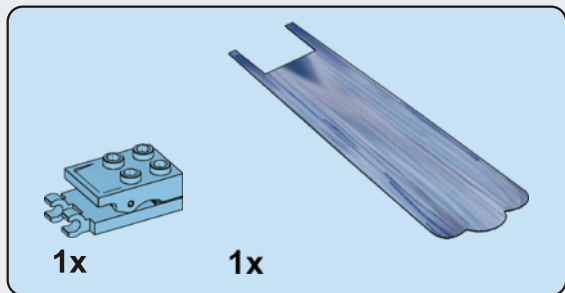

B34

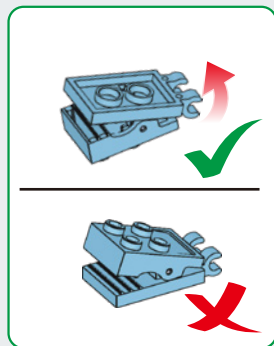
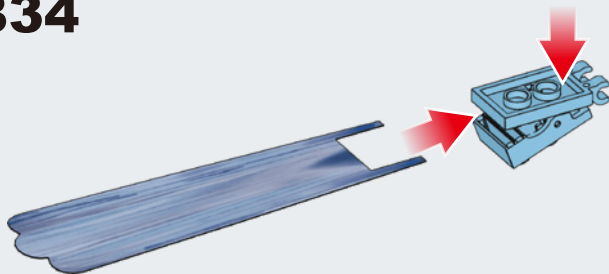

B35

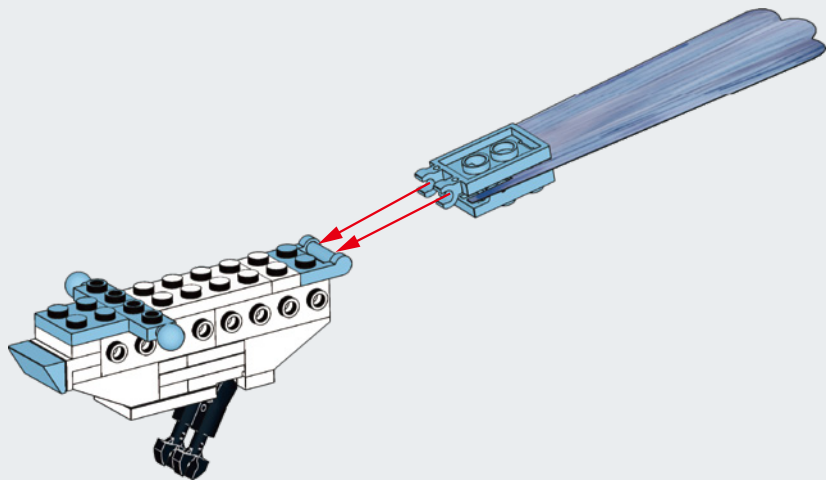



B36

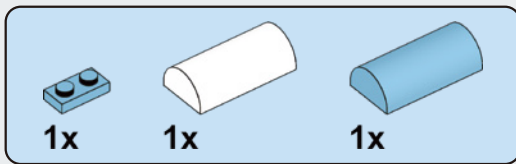
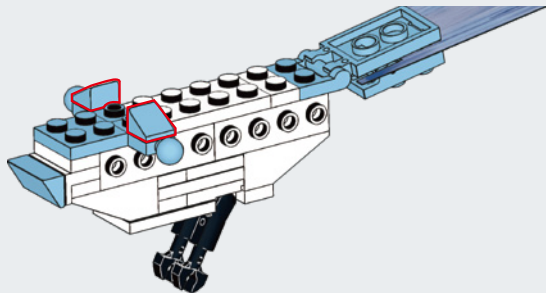

B37

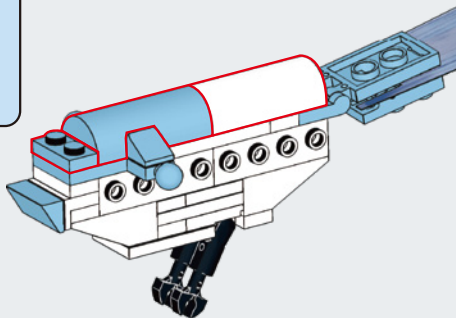

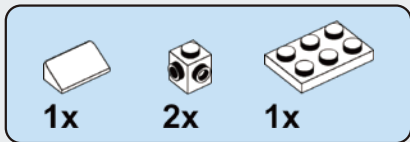

B38

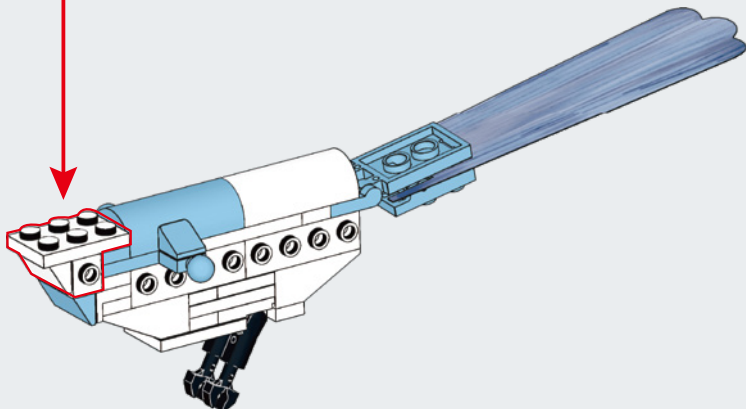
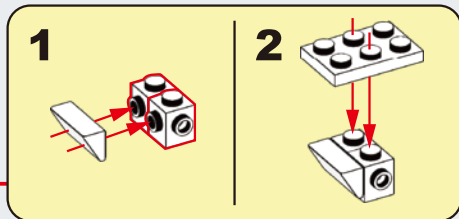

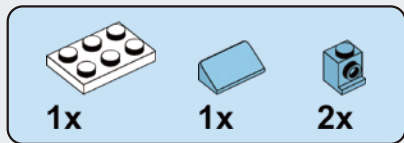

B39

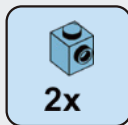
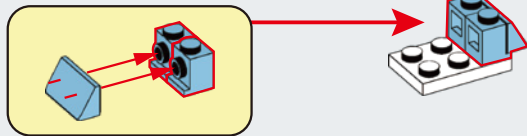

B40

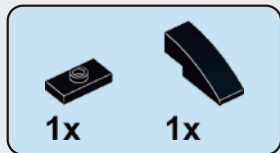
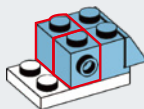

B41

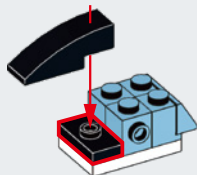

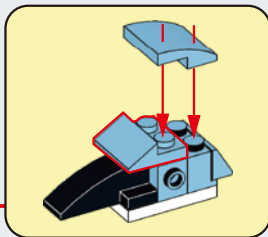
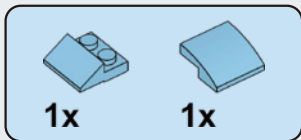

B42

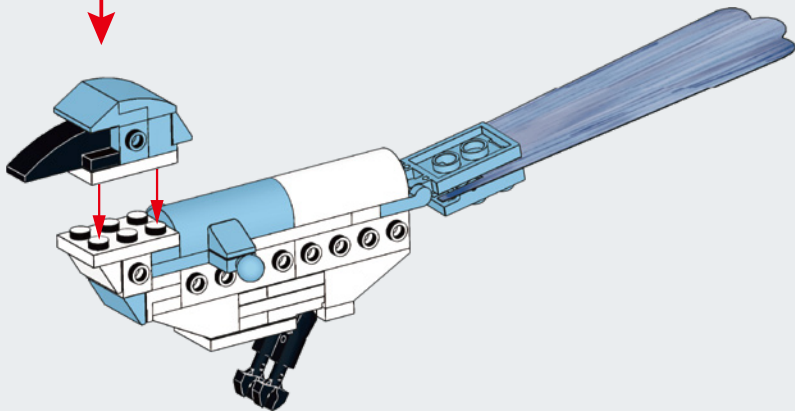

build beyond the brick!

403ARC710250001

CaDA® ELEMENTS

Paper + Brick Construction Set

382 PCS
C71025



Endangered Birds of North America



Build & Learn! >>>>
STEAM-based Play



The all new
CaDA Clip Brick