

A composite image of the solar system. In the bottom left corner, the Sun is shown as a large, glowing orange and yellow sphere with visible solar flares. In the upper right, the Earth is depicted as a blue and white planet with visible continents and clouds. To the left of the Earth, the Moon is shown as a smaller, grey, cratered sphere. The background is a dark, starry space filled with numerous small white stars.

THE SOLAR SYSTEM



地球 Earth

地球是距离太阳的第三颗行星，也是已知的唯一孕育和支持生命的天体。地球是由大陆和水组成的蓝色星球。大部分极地地区都被冰覆盖。大气主要由氮和氧组成。

Earth is the third planet from the Sun and the only known planet in the Universe to support life. Earth, our blue planet is made up of continents and oceans and the polar areas are covered with ice.

Our atmosphere contains mostly nitrogen and oxygen that helps keep us alive.

月球是围绕地球旋转的球形天体，同时也是地球的天然卫星。月球是地球唯一的天然卫星。

在汉语中被俗称为月或月亮，古时又称为太阴、玄兔、婵娟、玉盘。

The Moon is a spherical object that rotates around the Earth. It is also a natural satellite of the Earth.



月球 Moon

太阳 Sun

Fun facts!

- 地球到太阳的距离: 1.5亿公里
Distance from Earth to Sun: 150 million km
- 太阳半径: 696 340公里
Sun radius: 696 340km
- 太阳比地球宽109倍
Sun is 109 times wider than Earth
- 表面温度: 6000°C
Surface Temperature: 6000°C

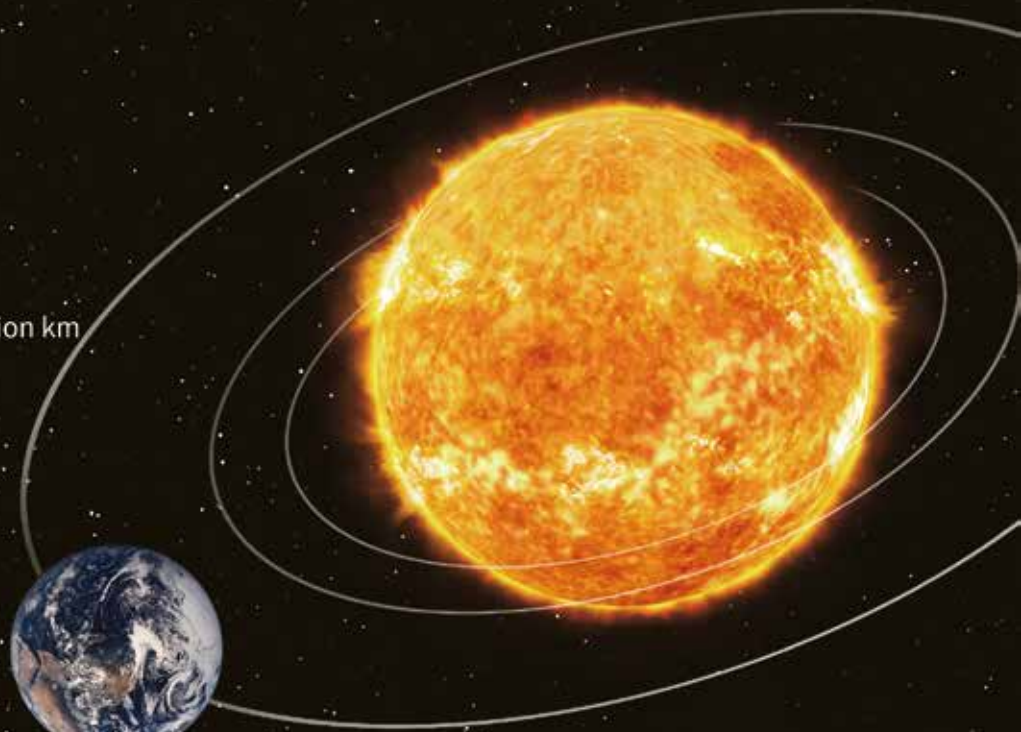

太阳是太阳系的中心天体, 占有太阳系总体质量的99.86%。太阳系中的天体, 都围绕着太阳公转, 而太阳则围绕着银河系的中心公转。

从物理上看, 太阳采用核聚变的方式向太空释放光和热。

Sun is the central object of our solar system and accounts for 99.86% of its total mass. The planets of the solar system revolve around the Sun, while the Sun revolves around the center of the Milky Way.

The Sun is a powerful source of energy, releasing light and heat into space in the form of nuclear fusion.

月球 Moon

Fun facts!

- 从地球到月球的距离:384400公里
Distance from Earth to Moon: 384 400 km
- 月球半径:1737.4公里
Moon radius: 1737.4 km
- 地球比月球宽4倍
Earth is 4 times wider than Moon
- 表面温度:从-173°C到+137°C
Surface Temperature: from -173 °C up to +137 °C



地球 Earth

Fun facts!

- 地球是已知唯一维持生命的行星。
Earth is the only planet known to maintain life.
- 地球半径:6371公里
Earth radius: 6371 km
- 地球是太阳系第五大行星
Earth is the 5th largest planet in the Solar System
- 平均表面温度:15°C
Average Surface Temperature: 15°C



中国二十四节气

The 24 Solar Terms of the Traditional Chinese Calendar

“二十四节气”是上古农耕文明的产物，它不仅在农业生产方面起着指导作用，同时还影响着古人的衣食住行，甚至是文化观念。

如今，二十四节气早就走向了世界。有的地方虽然季节变换不明显，但那里的人民依然在传承、弘扬着二十四节气及其附着的文化，充分表明了它的文化价值。

The 24 solar terms, based on the Sun's position in the zodiac, were created by farmers in ancient China to guide the agricultural affairs and farming activities. The 24 solar terms reflect the changes in climate, natural phenomena, agricultural production, and other aspects of human life, including clothing, food, housing, and transportation.





Designer Introduction

I've been building with construction bricks for most of my life, and I've always been fascinated with making them move. Getting models to move in interesting, complex or unique ways is a challenge that keeps me motivated and pushes my creativity. Not to mention, it usually results in a model that is really cool to look at. I'm also inspired by many old mechanical devices, as it truly amazes me what people have achieved with simple collections of gears and linkages. I hope you enjoy building my creations as much as I enjoyed designing them!

Designer: JK Brickworks

A handwritten signature in white ink on a dark background. The signature reads 'JK' on the top line and 'Brickworks' on the bottom line, written in a cursive style.

1

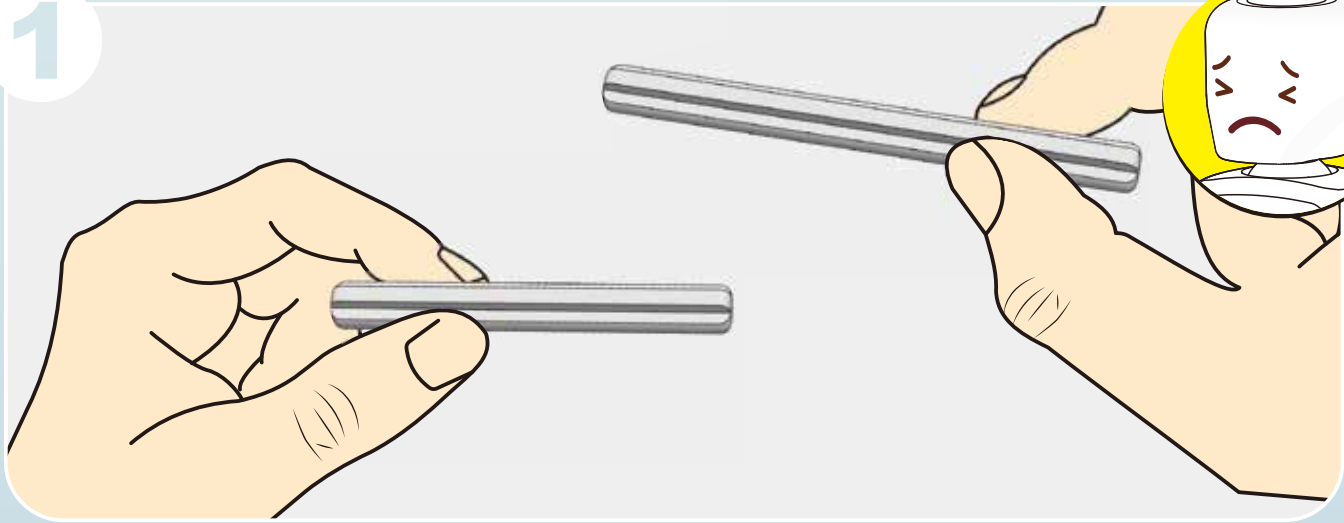

2

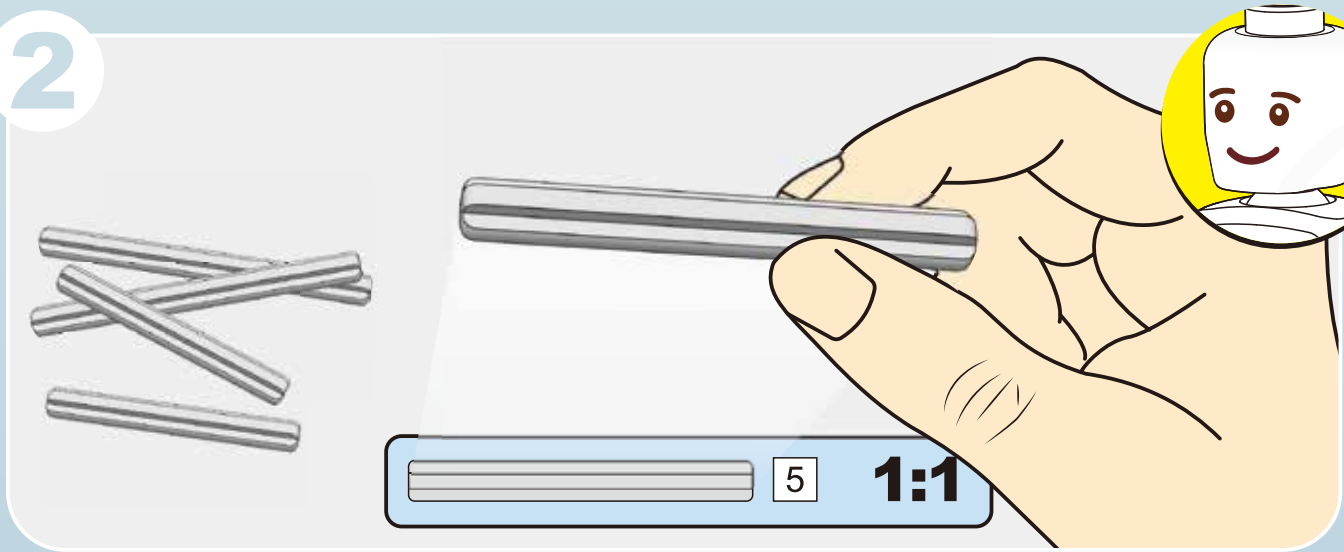

1

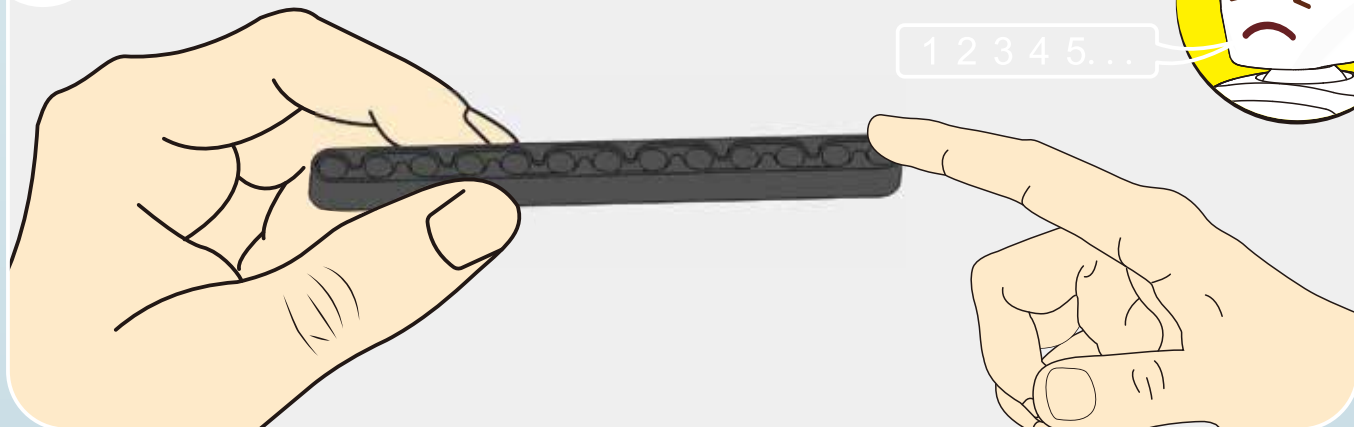

2

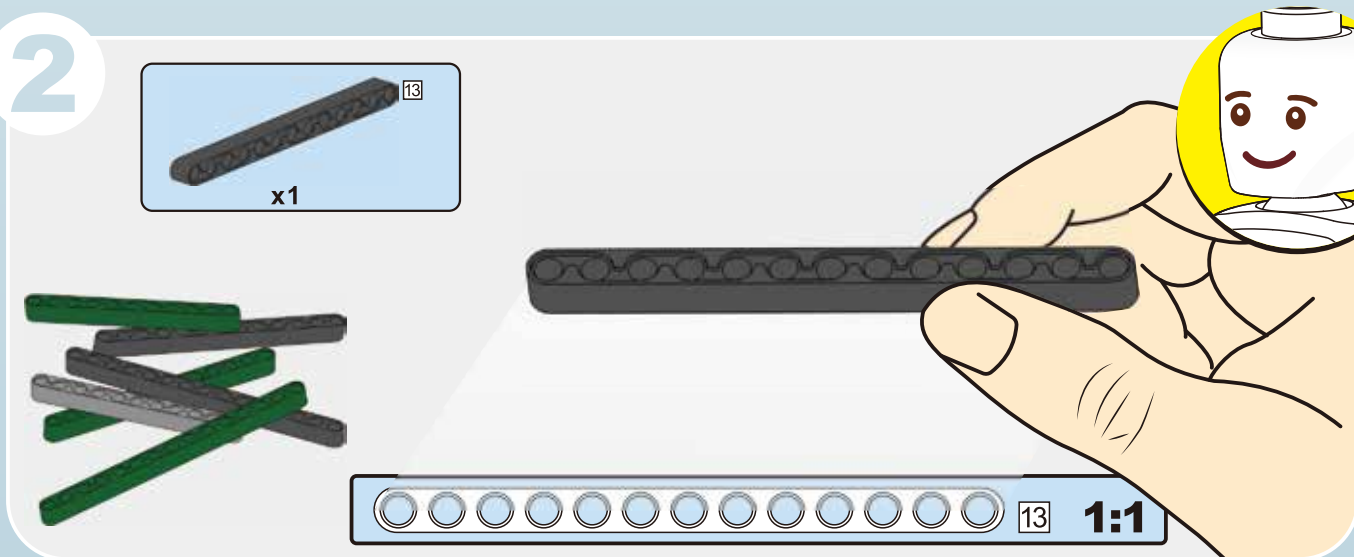

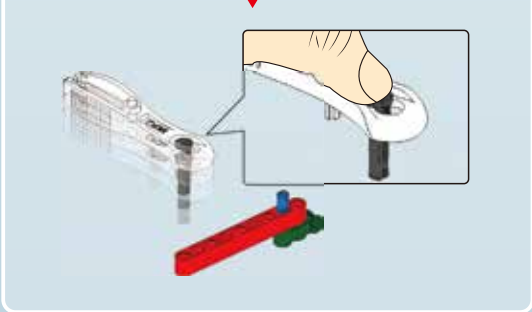
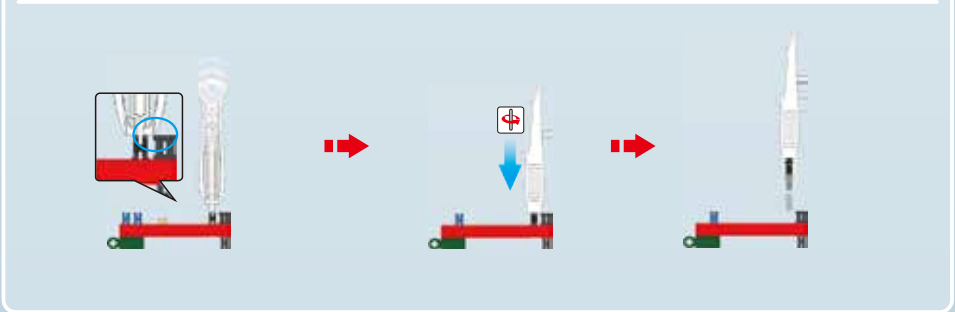
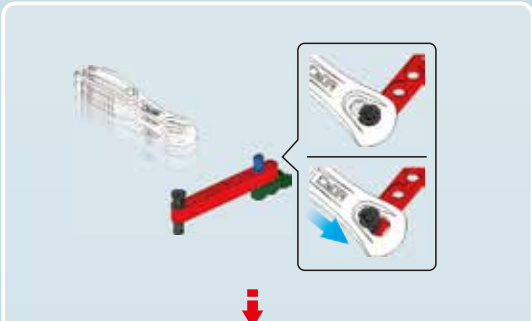
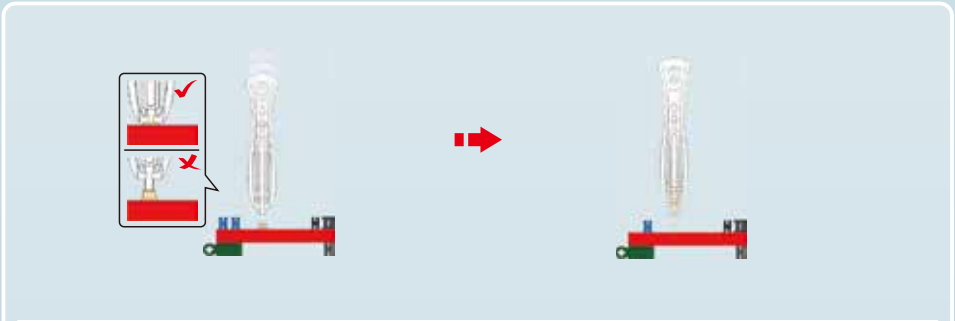
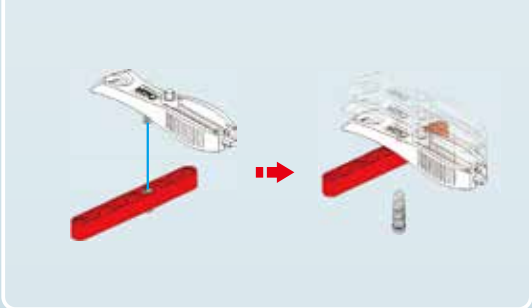
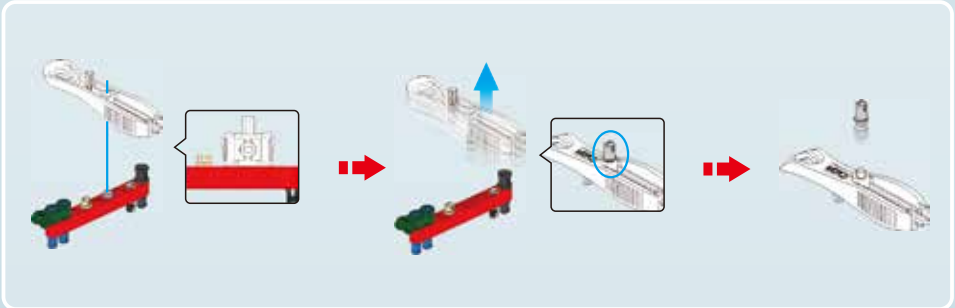
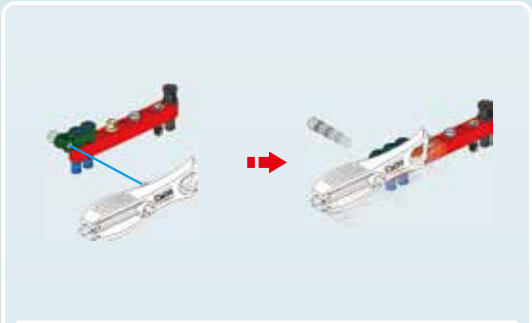
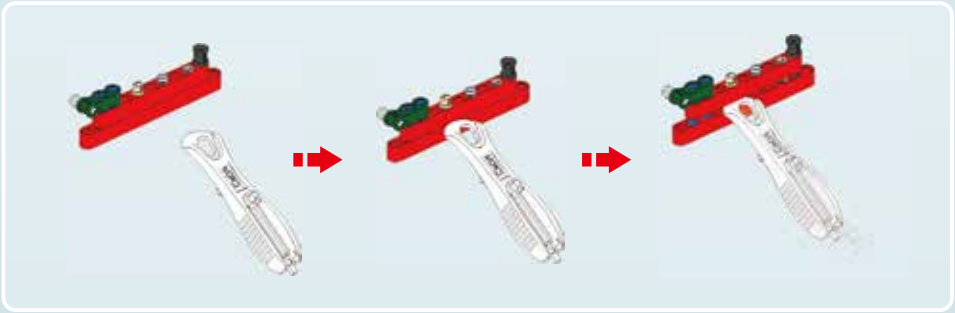

1

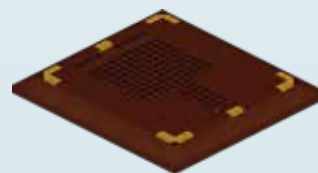

A

2



+

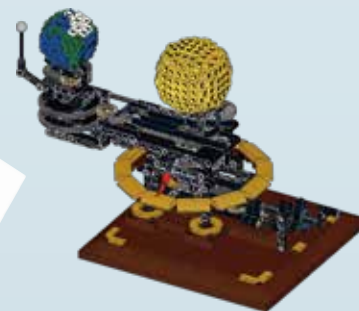

B

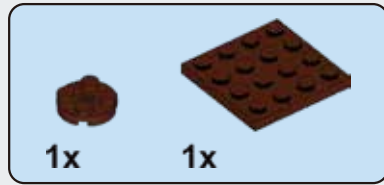
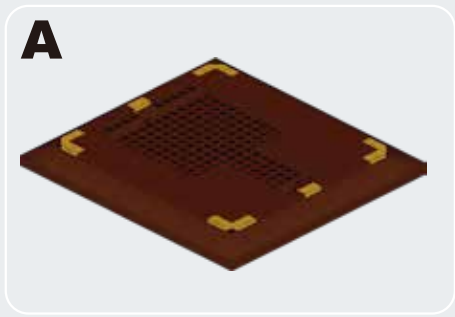

A1

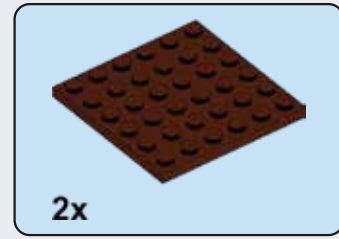
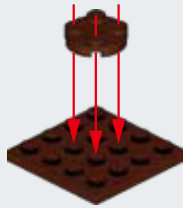

A2

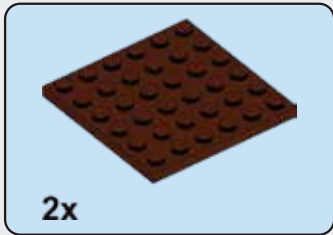
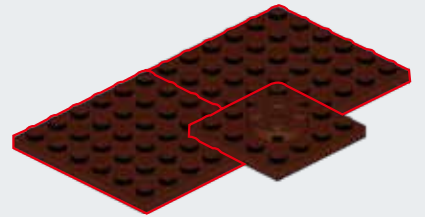

A3

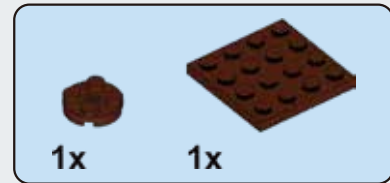
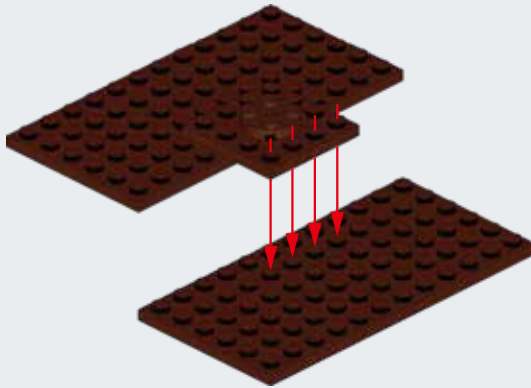

A4

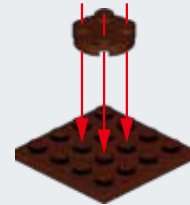

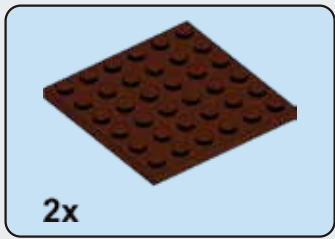

A5

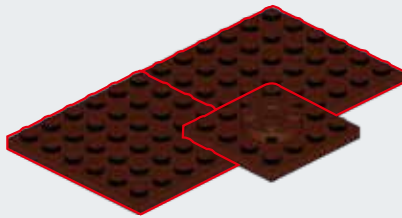

A6

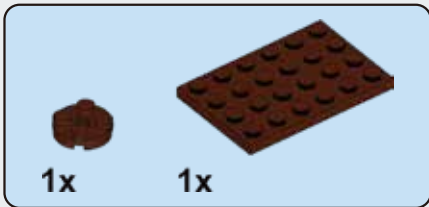
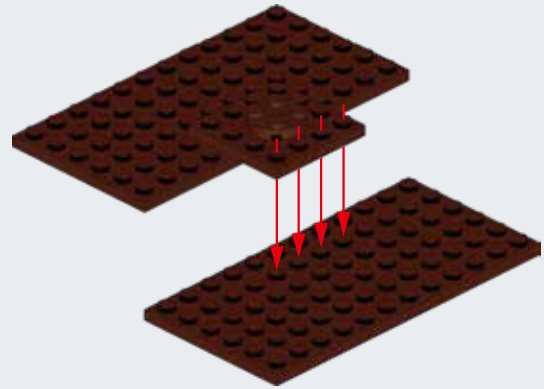

A7

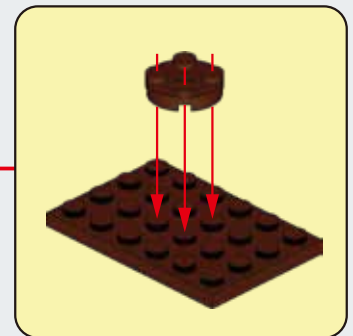
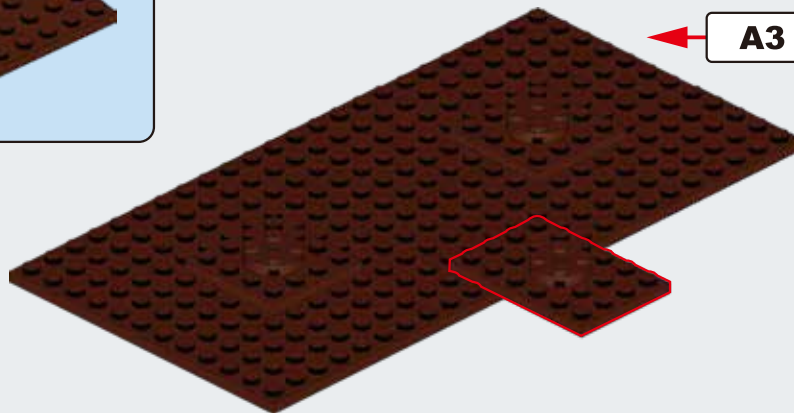

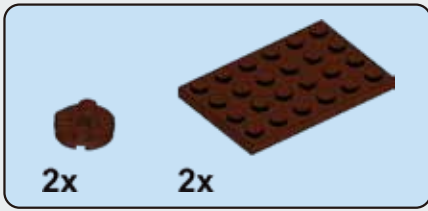

A8

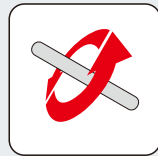
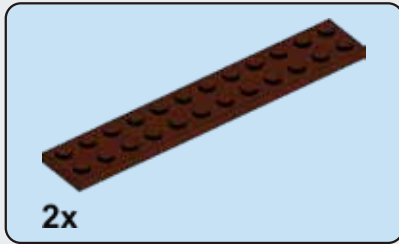
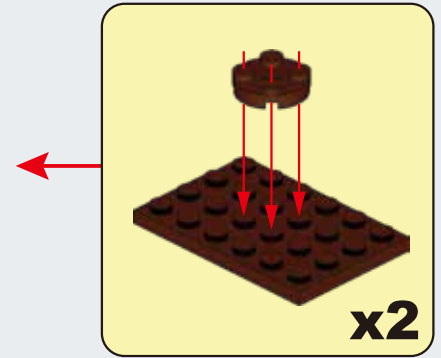
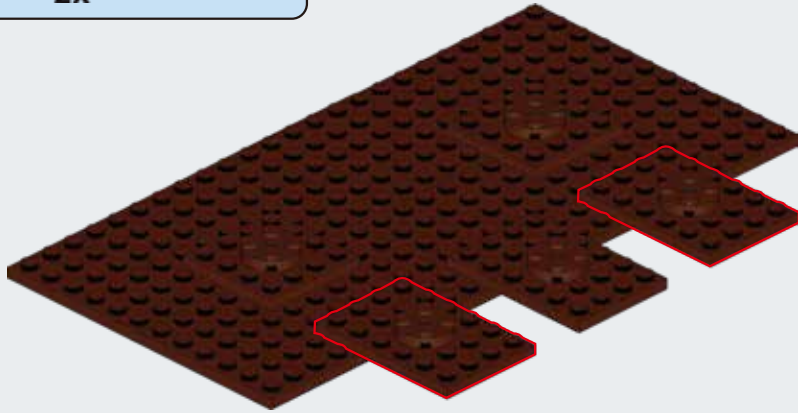

A9

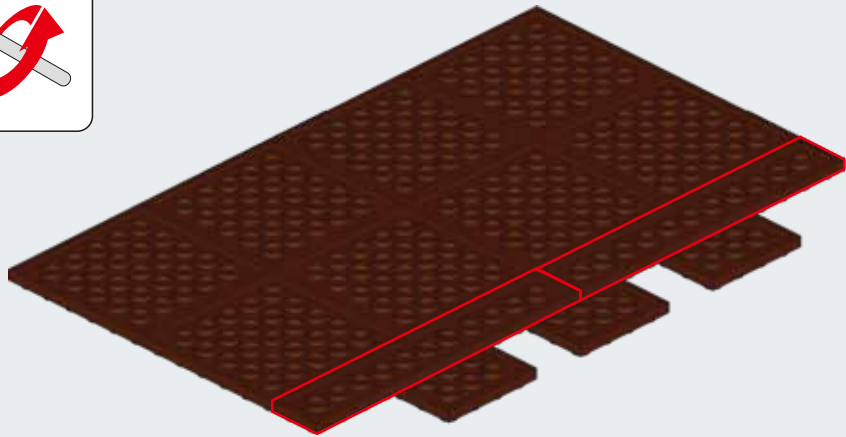

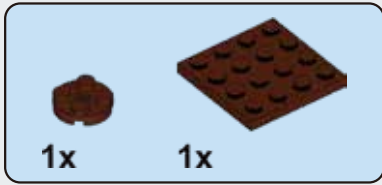

A10

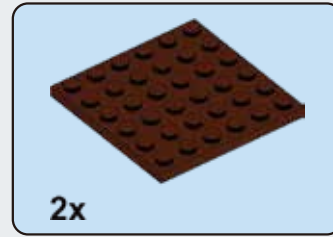
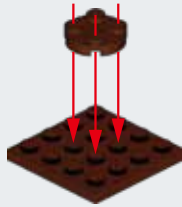

A11

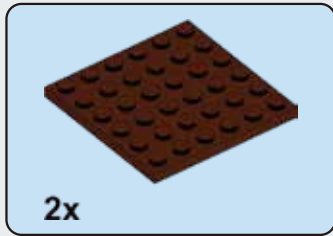
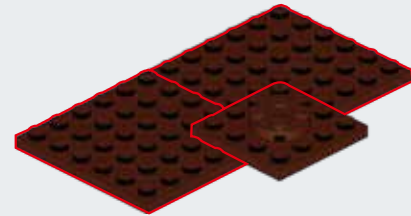

A12

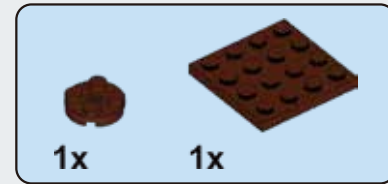
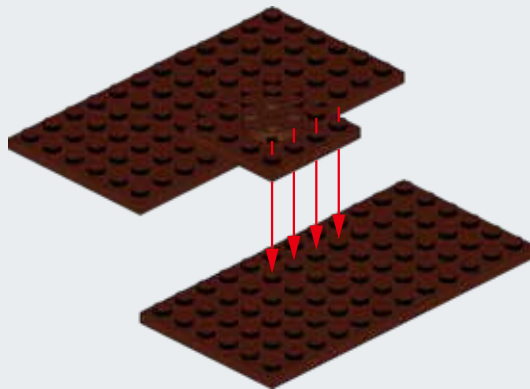

A13

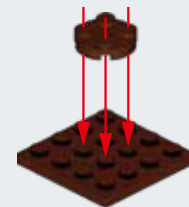

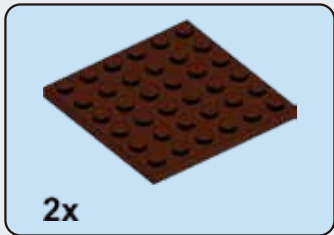

A14

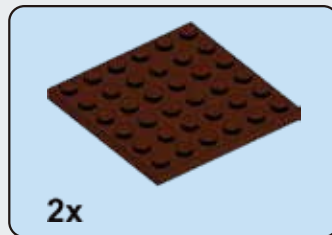
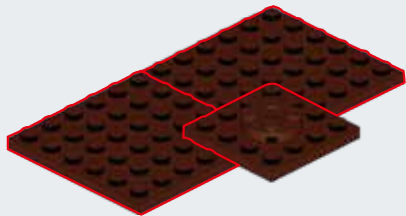

A15

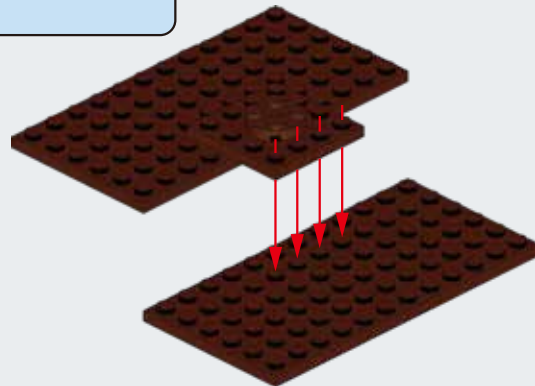

A16

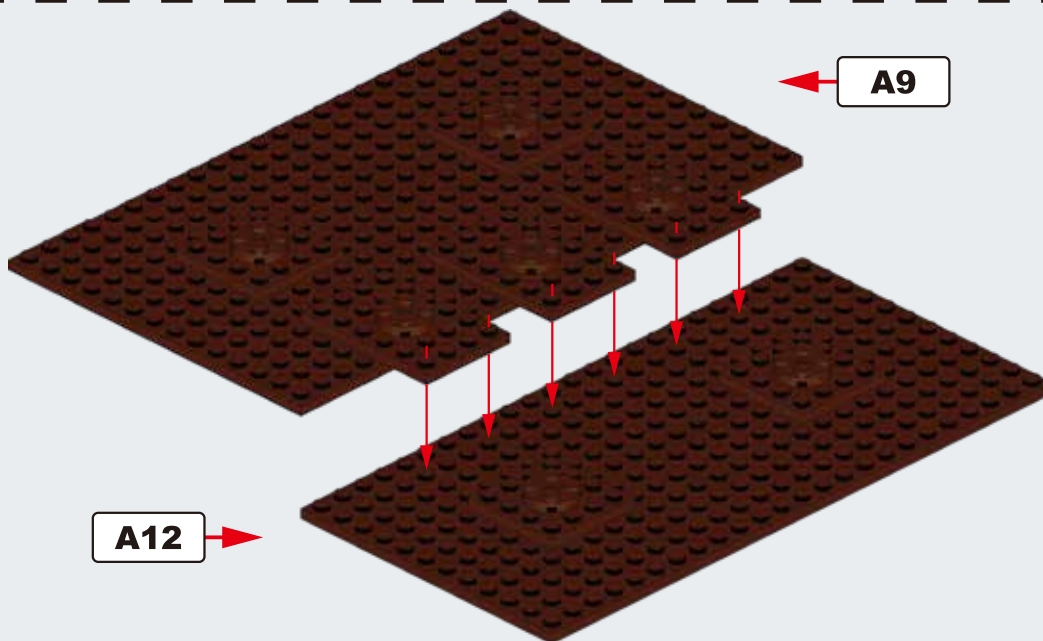

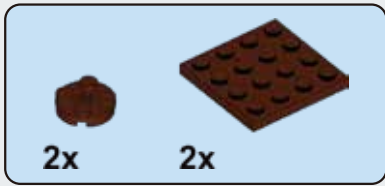

A17

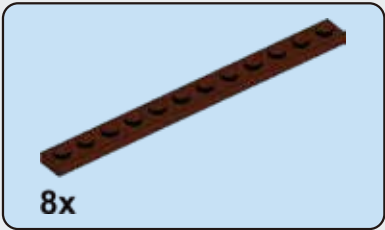
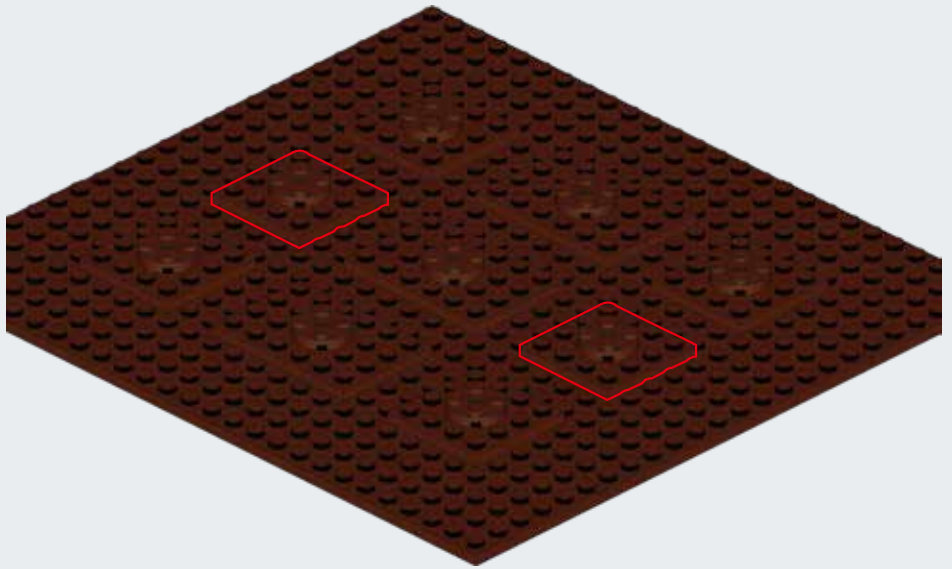
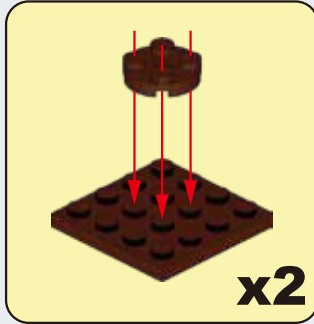

A18

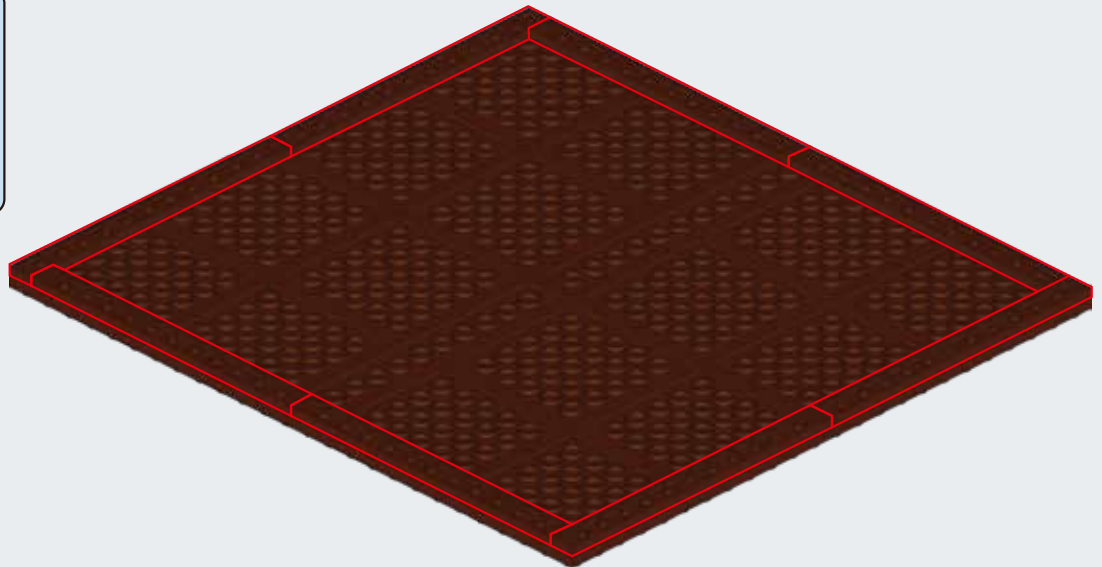
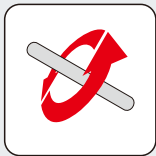

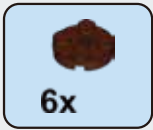

A19

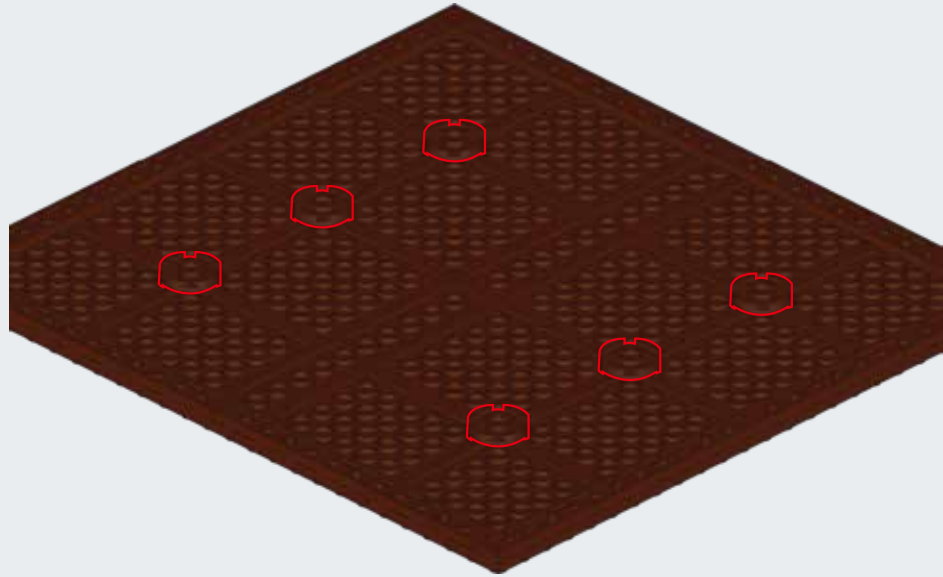

A20

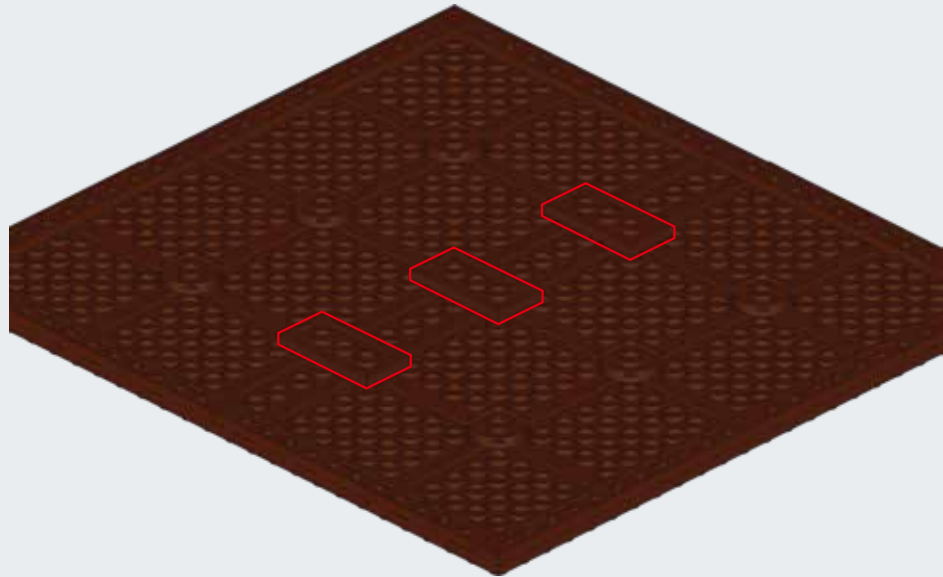

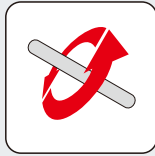
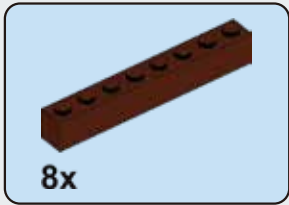

A21

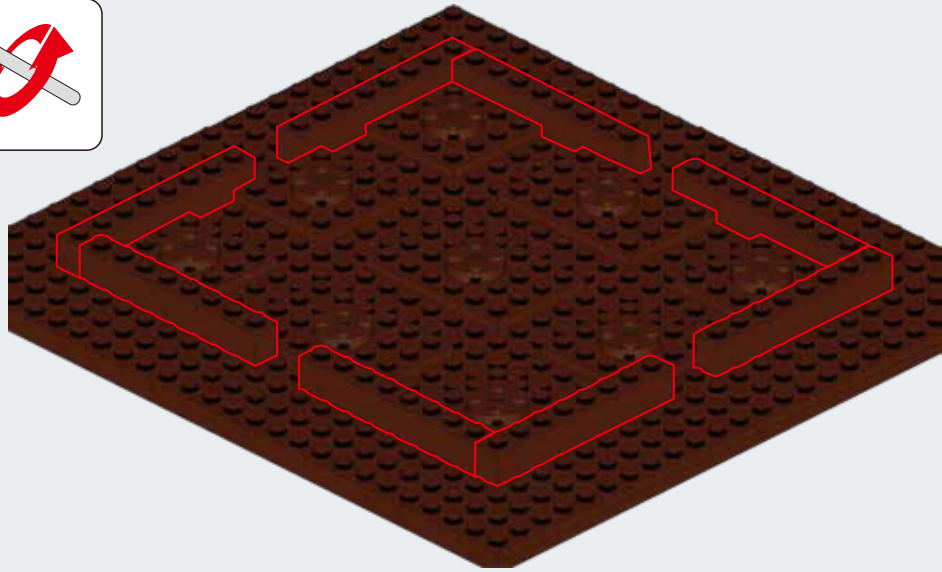

A22

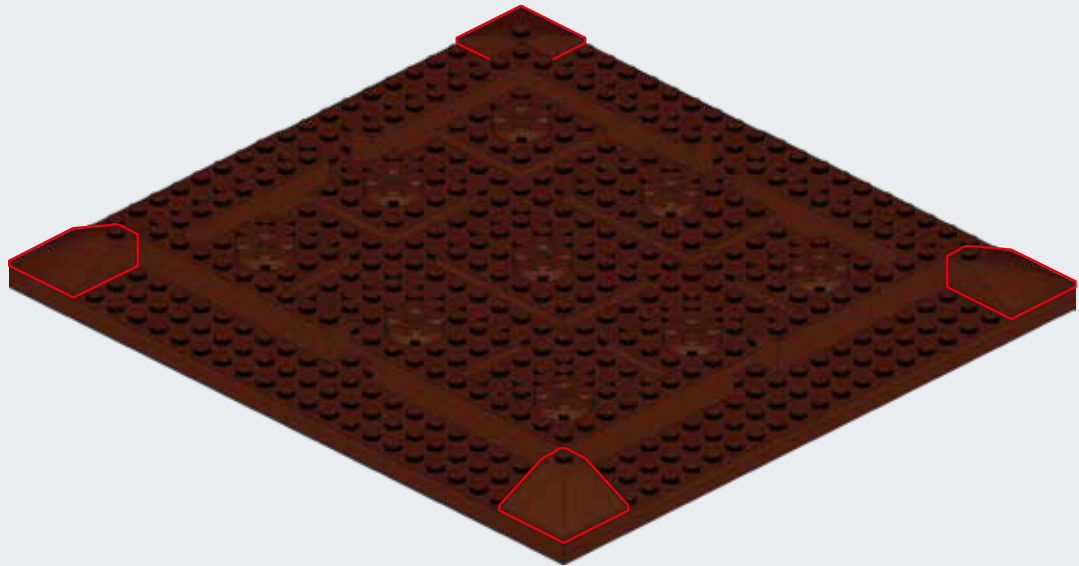



A23

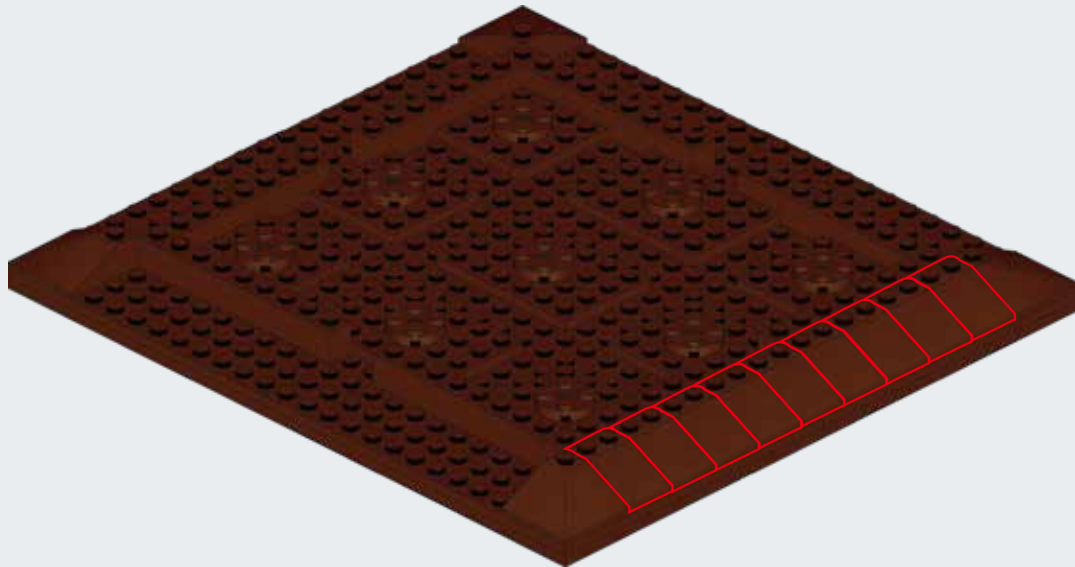

A24

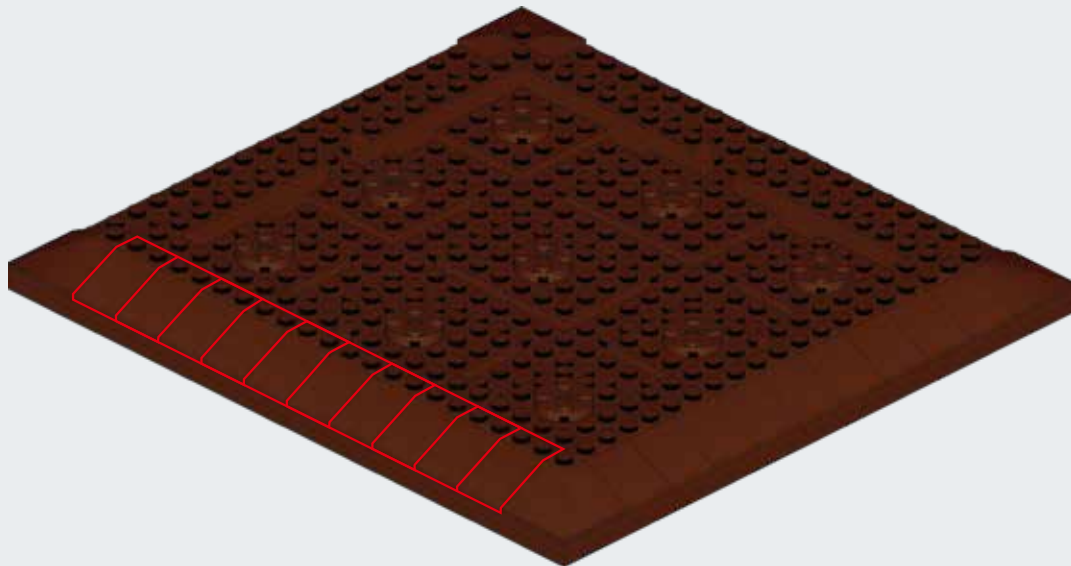



A25

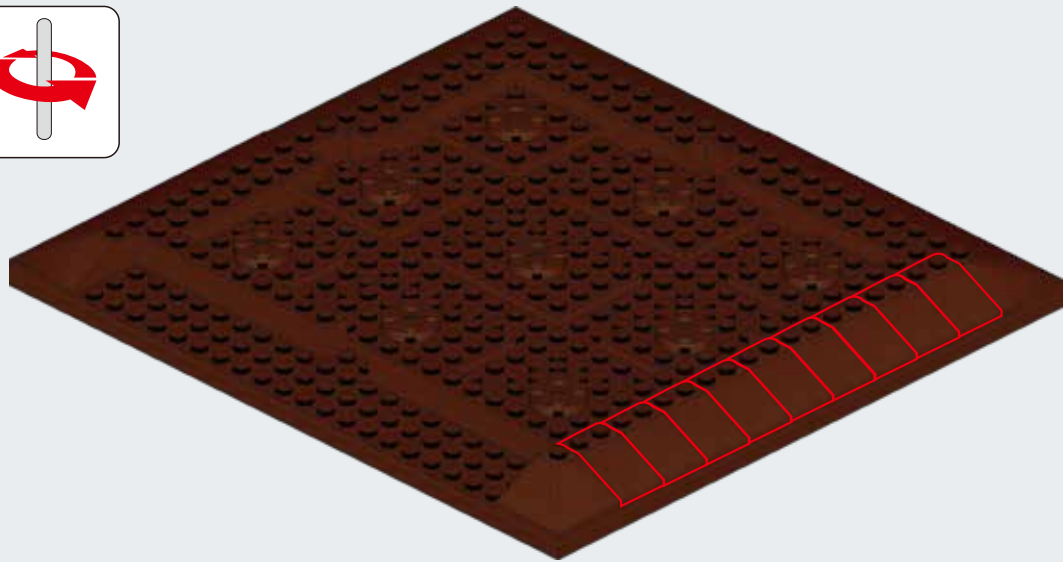
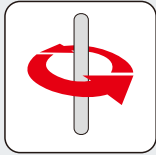

A26

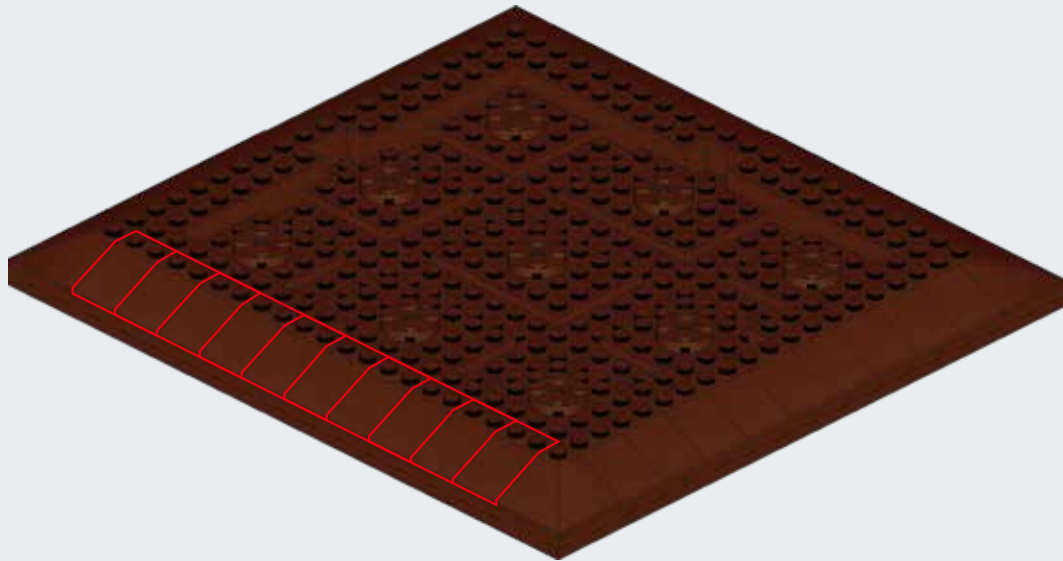

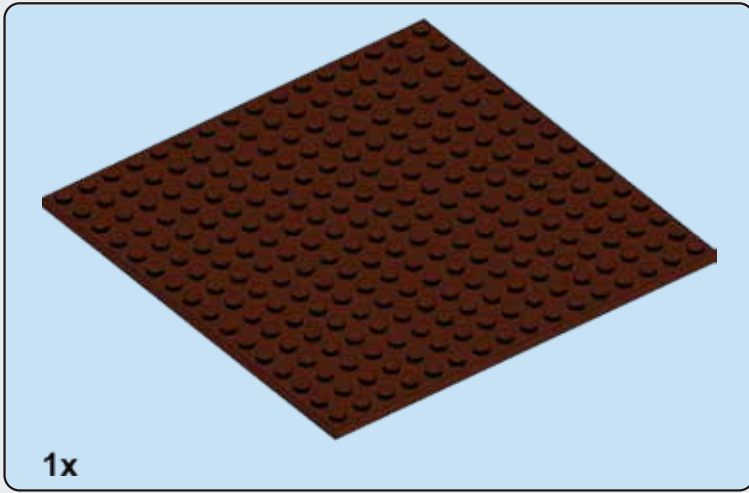

A27

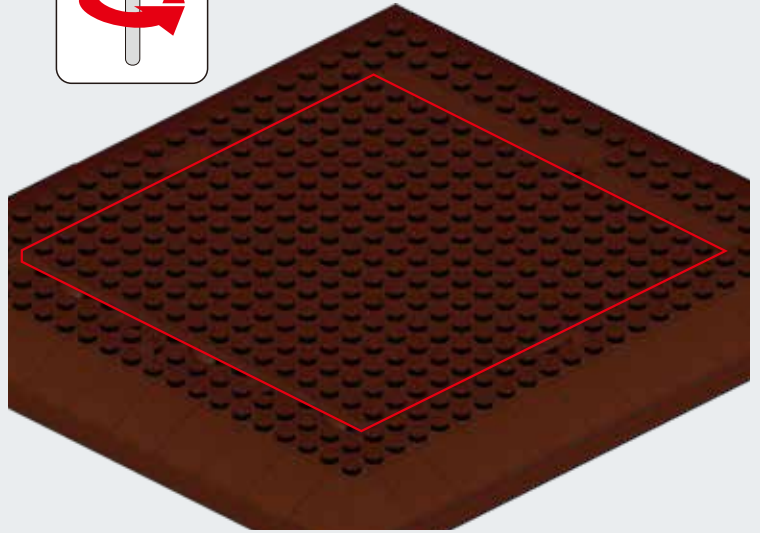
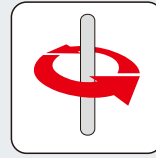

A28

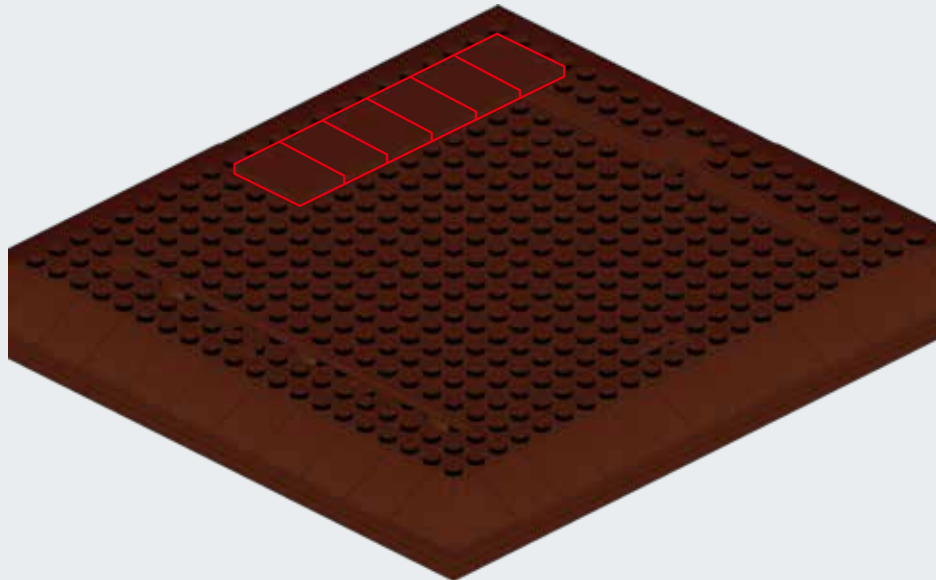

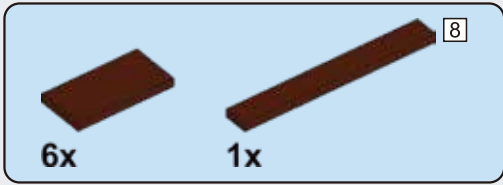

A29

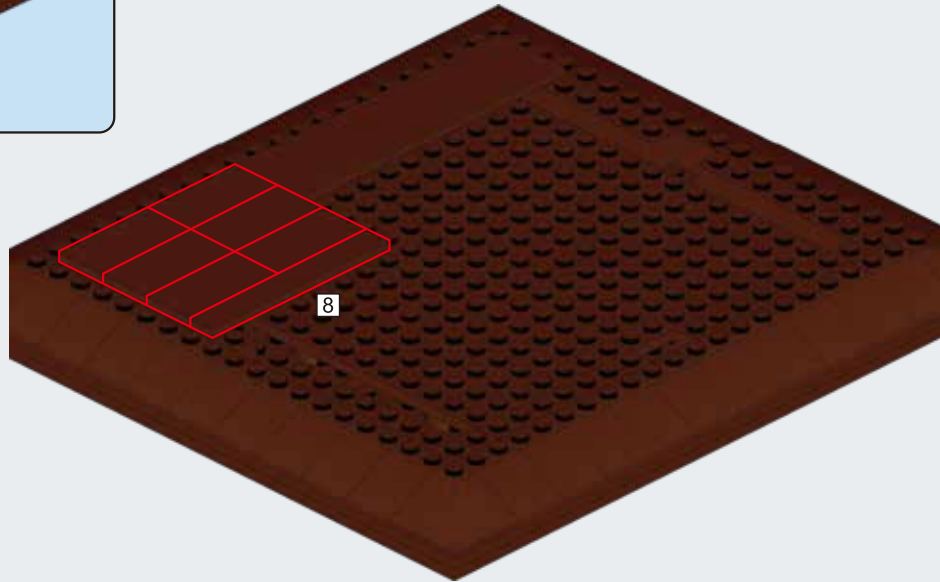

A30

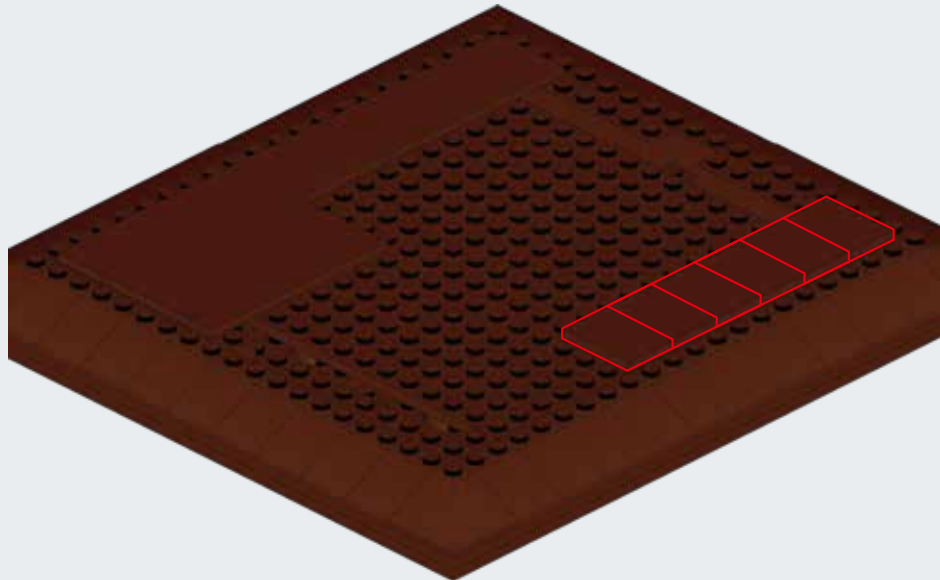

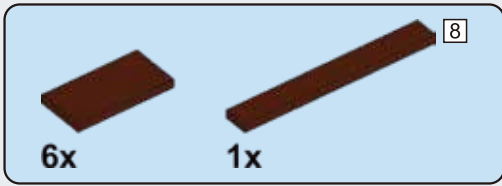

A31

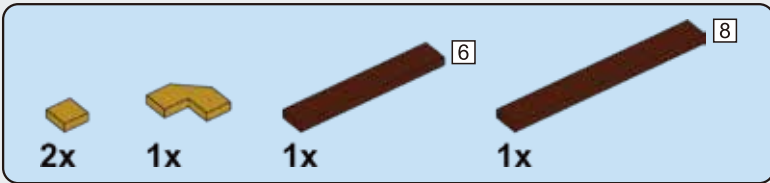
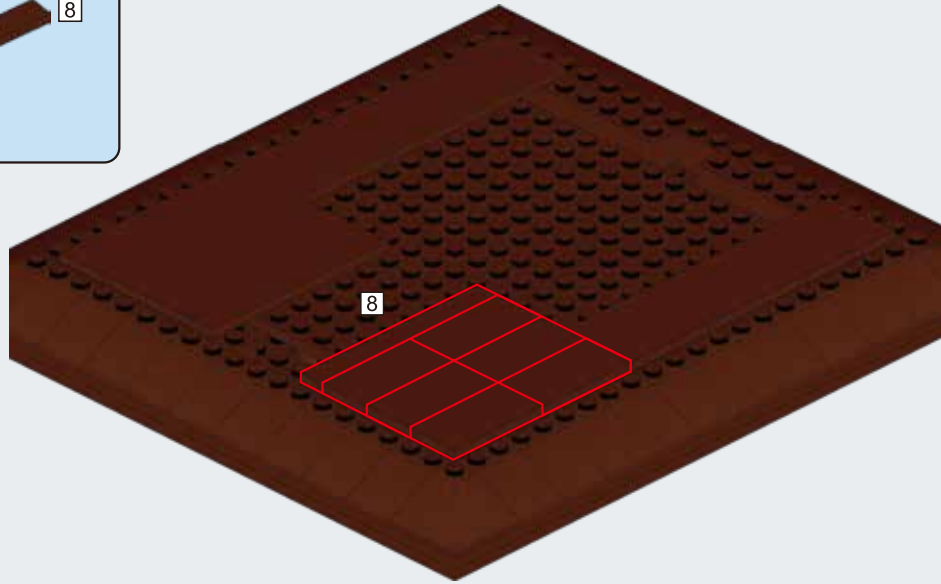

A32

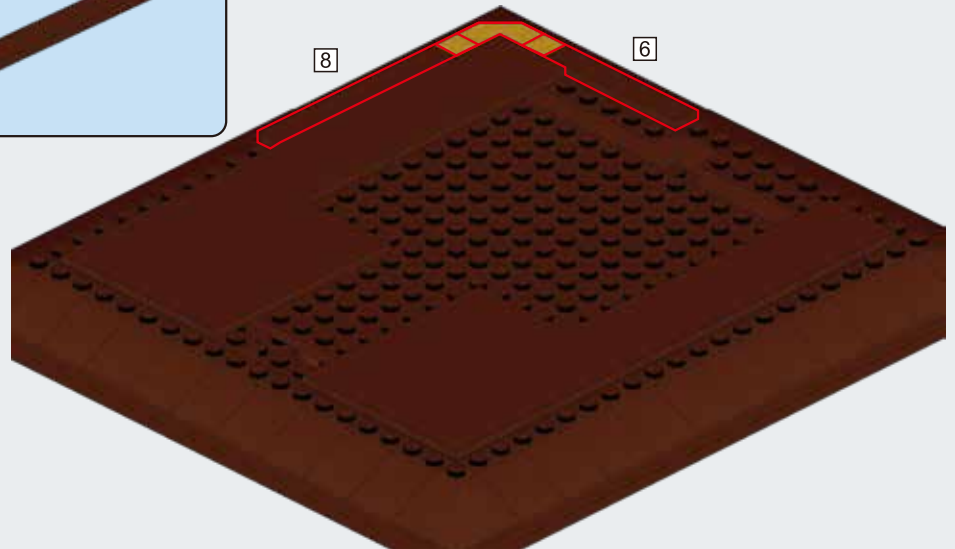

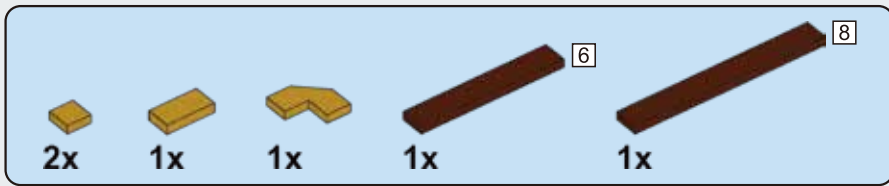

A33

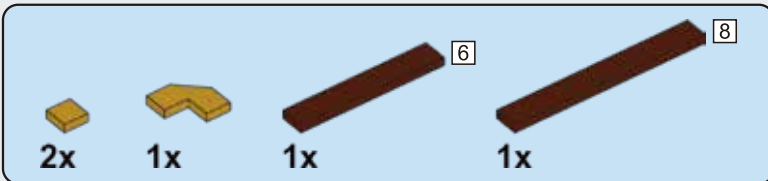
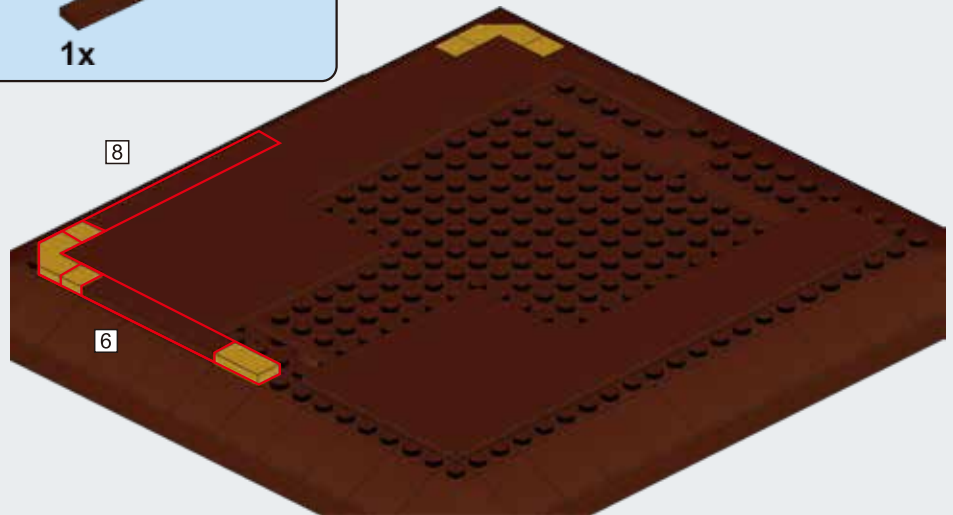

A34

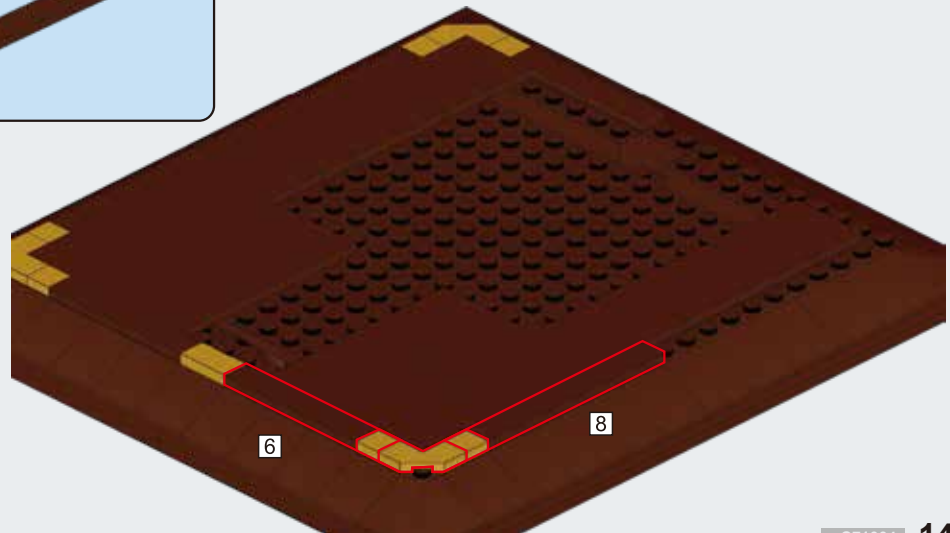

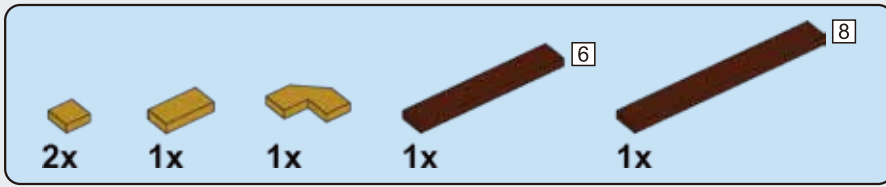

A35

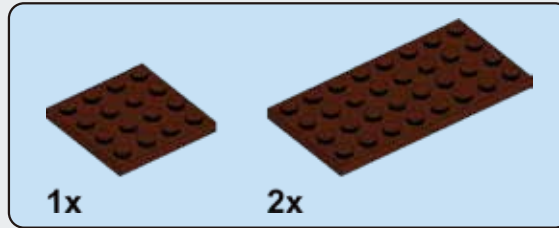
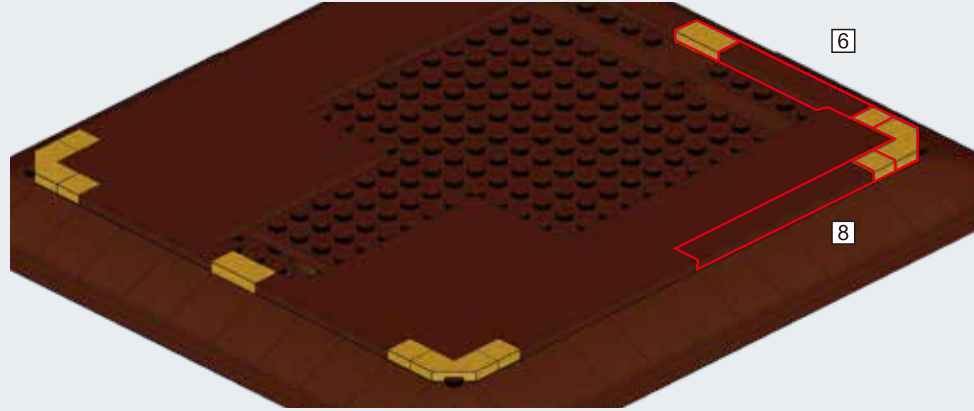

B1

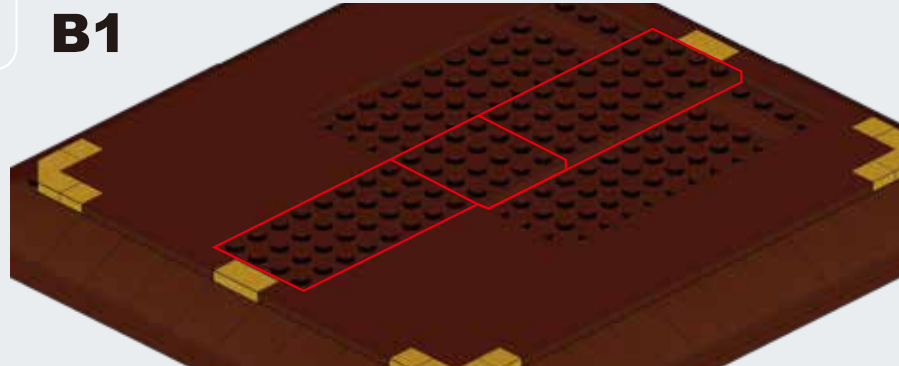



B2

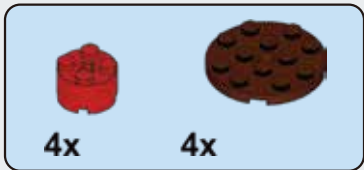
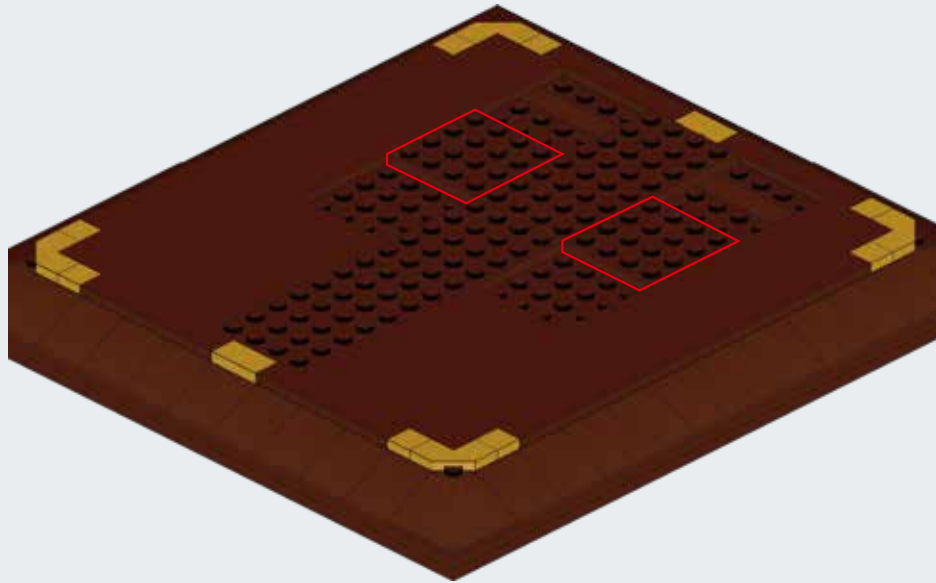

B3

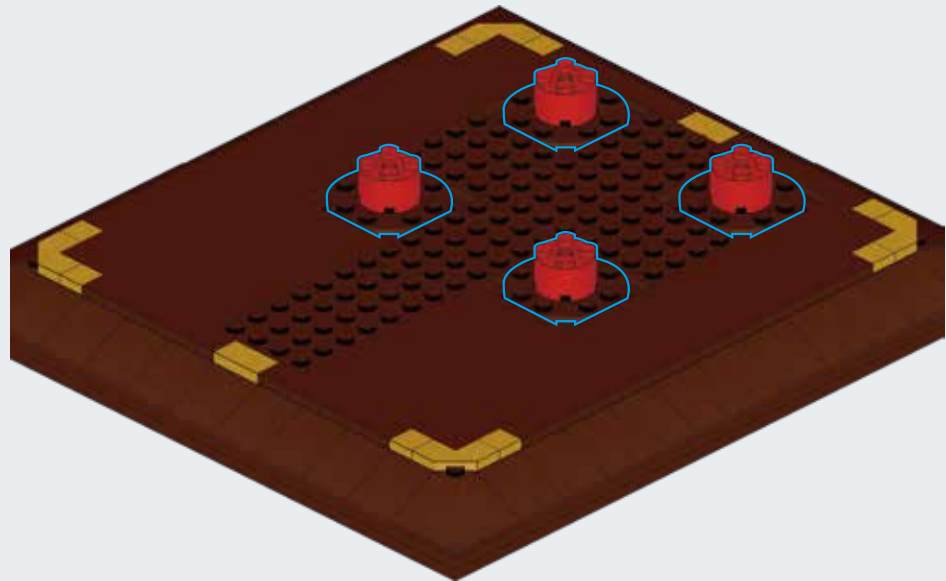
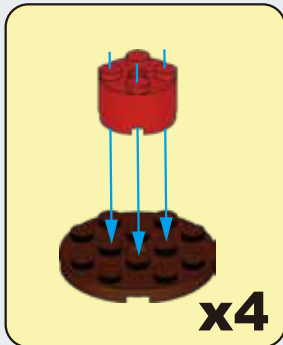

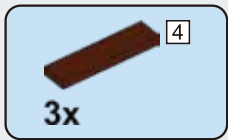

B4

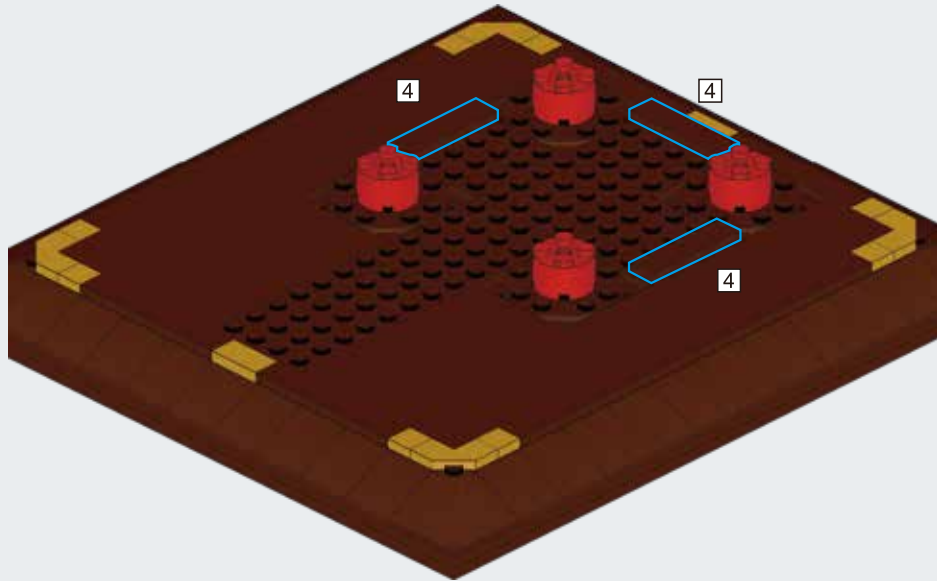

B5

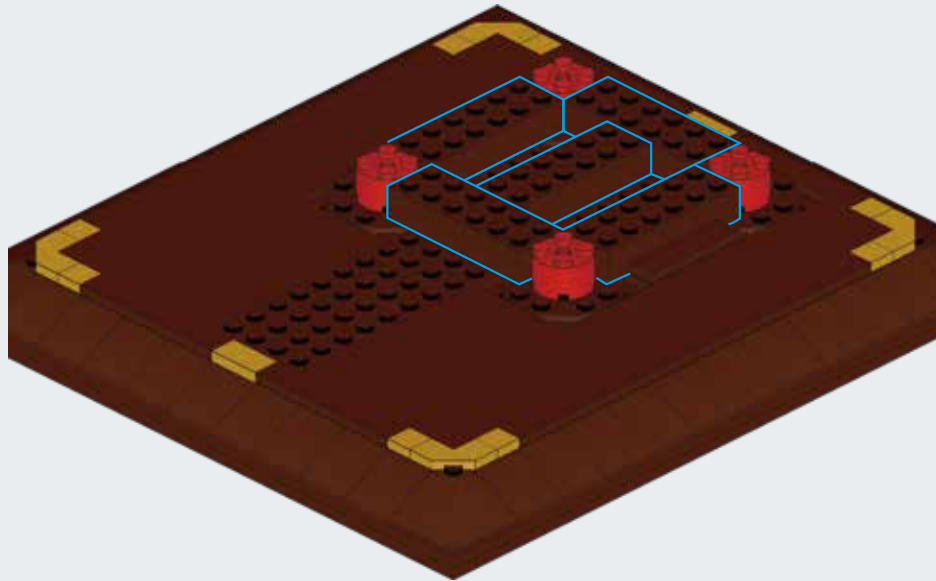

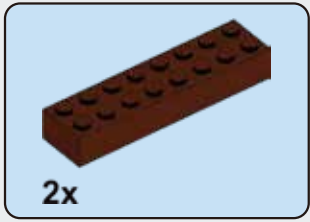

B6

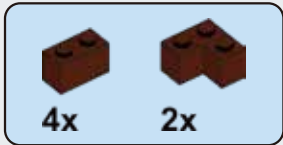
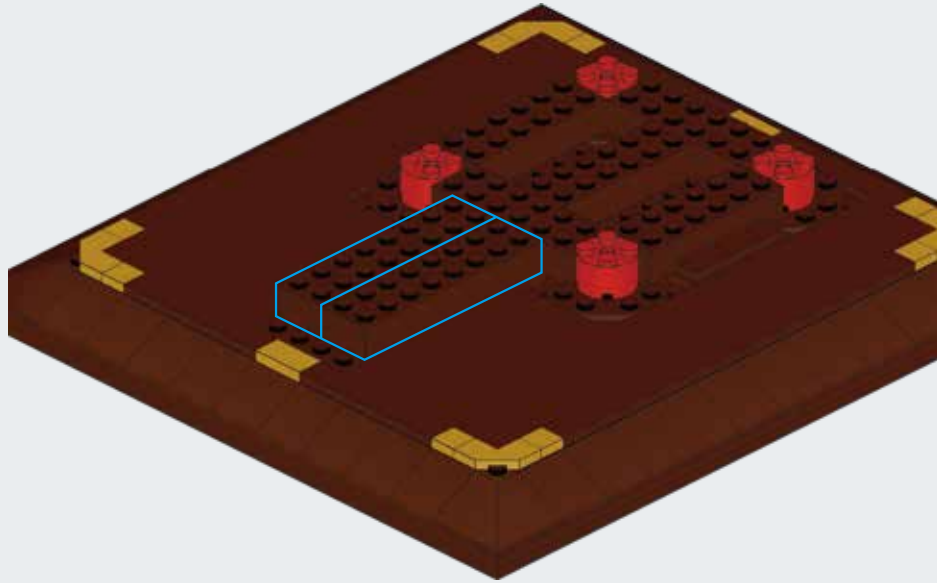

B7

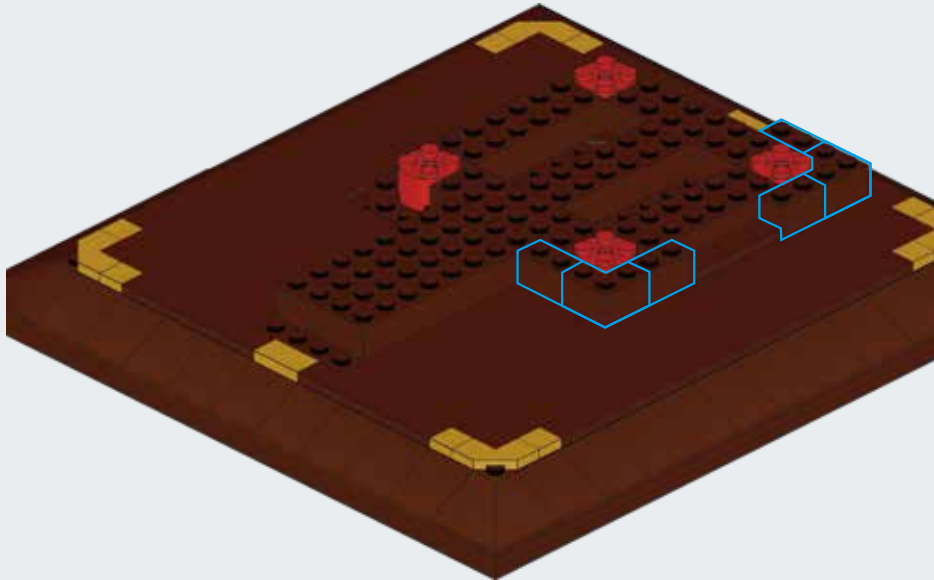

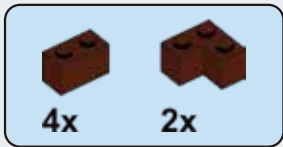

B8

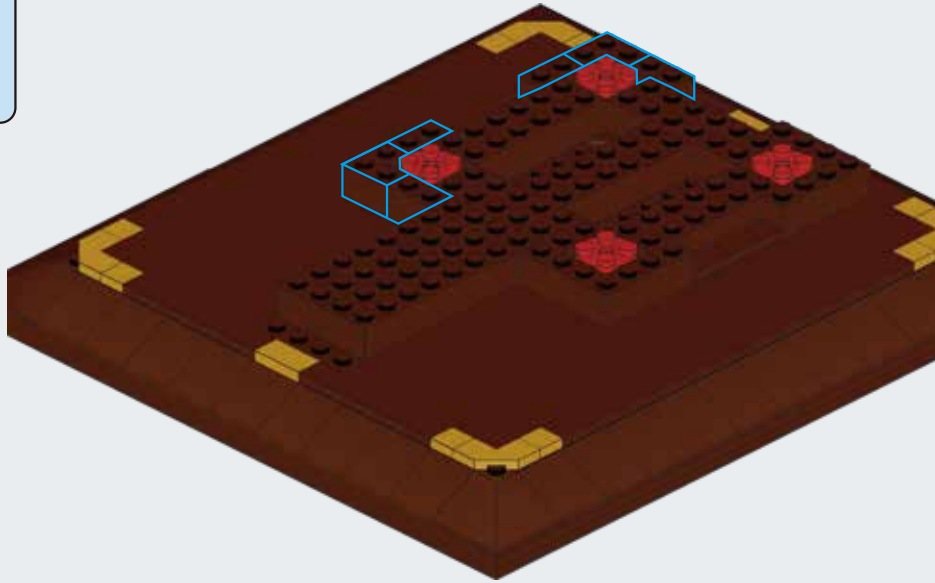

B9

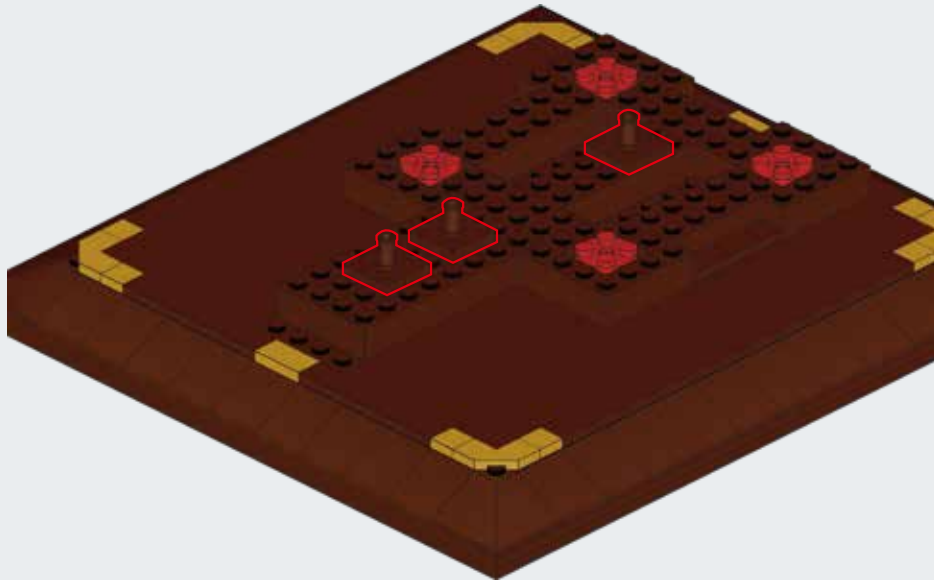

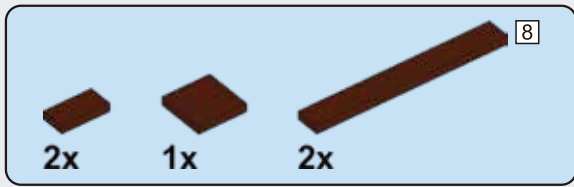

B10

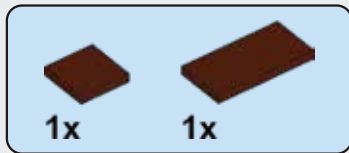
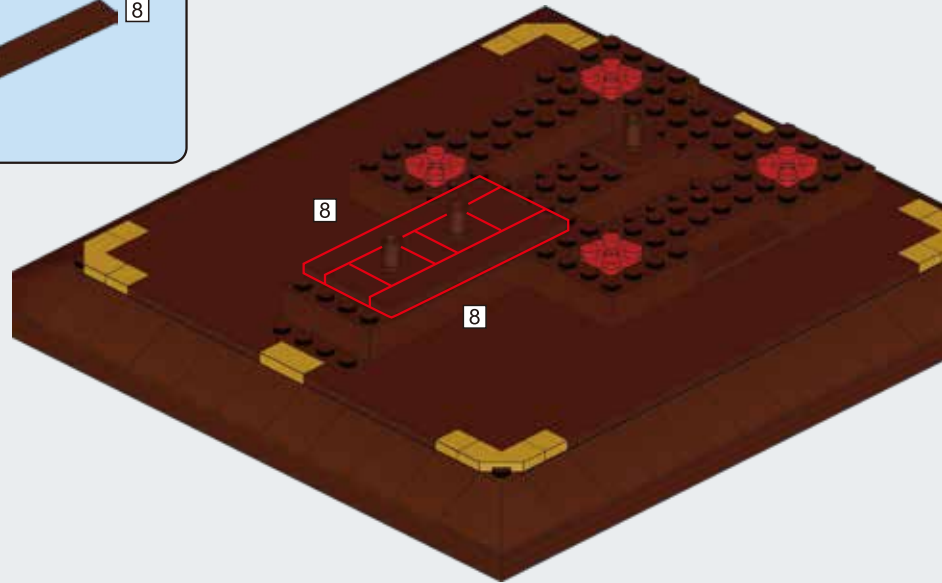

B11

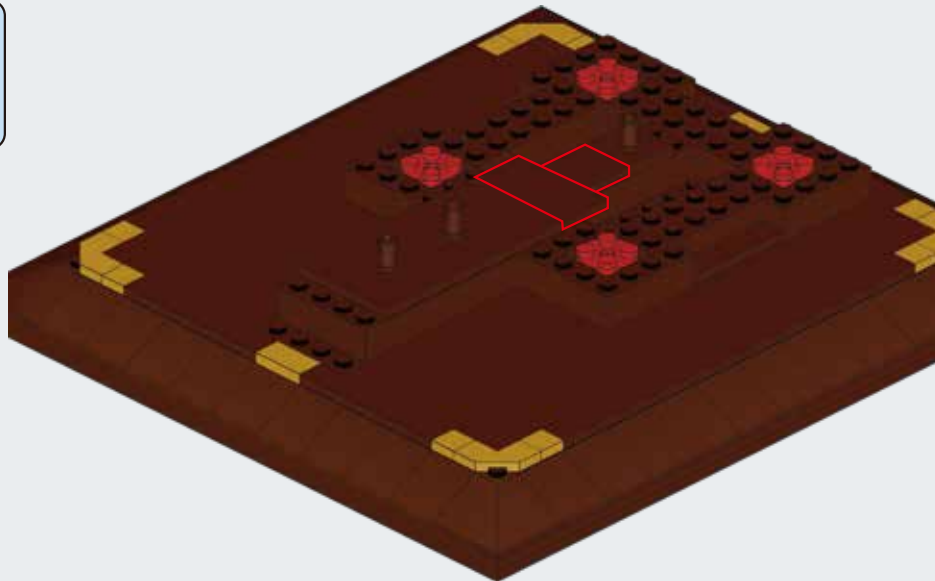

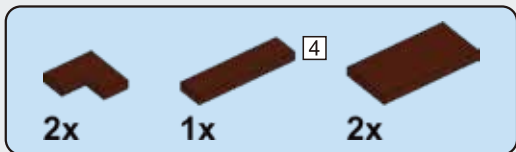

B12

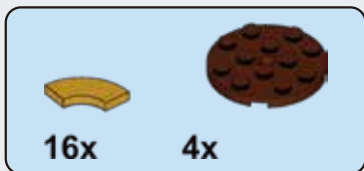
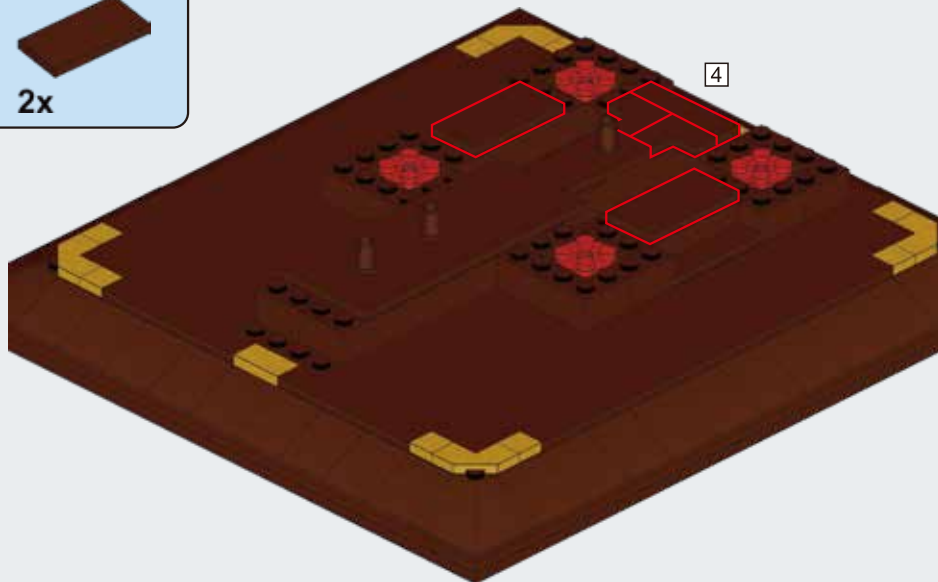

B13

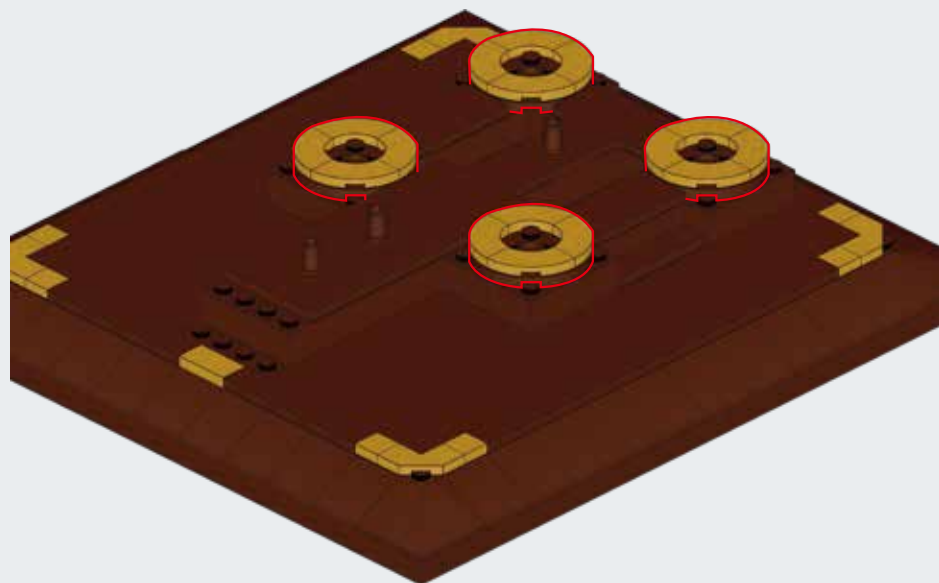
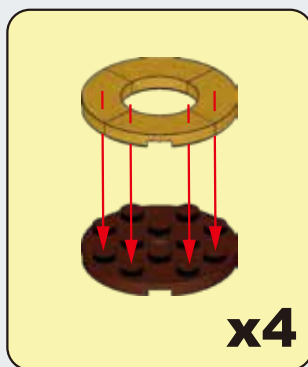

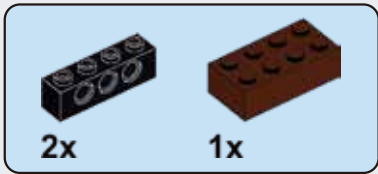

B14

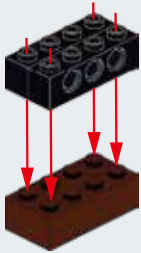

B15

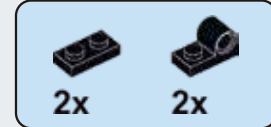
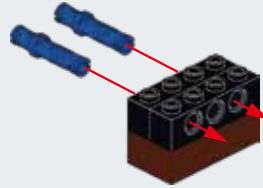

B16

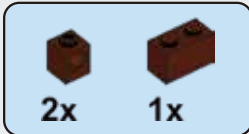
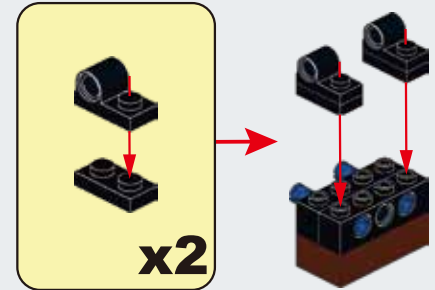

B17

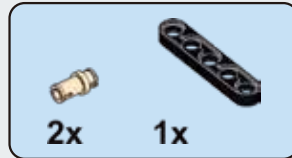
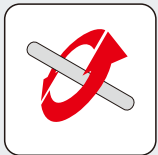

B18

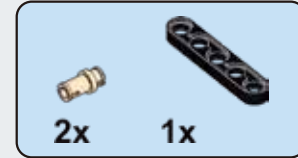
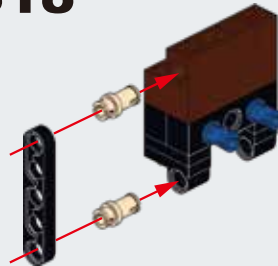

B19

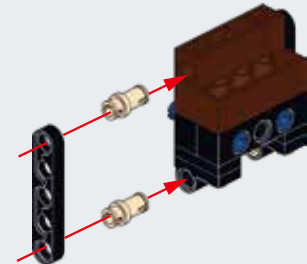

B20

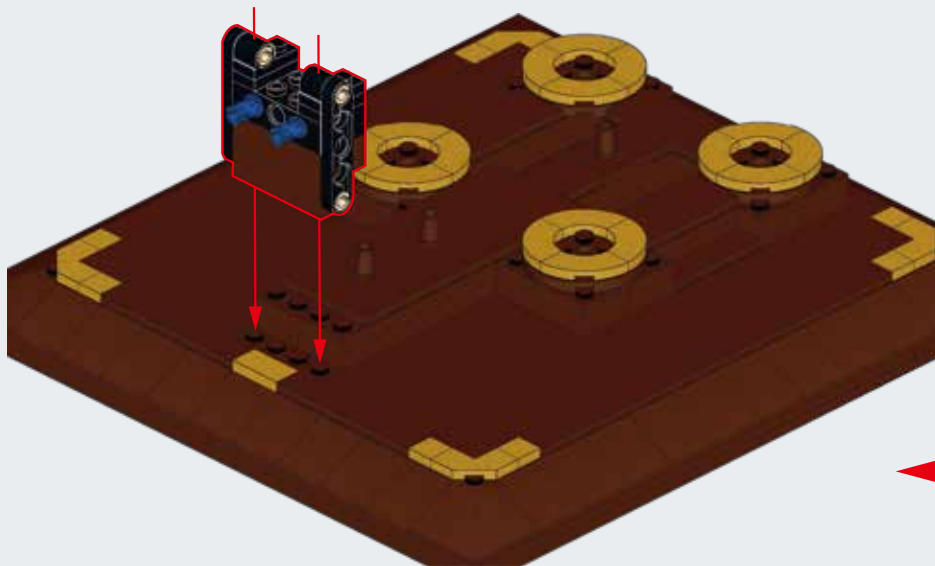
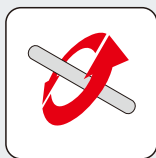

B13

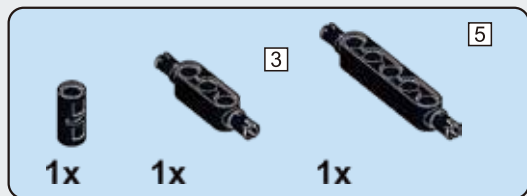

B21

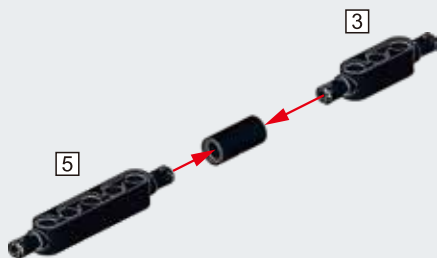

B22

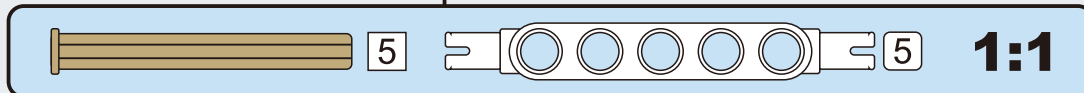
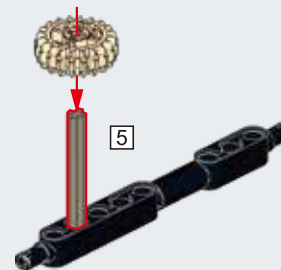

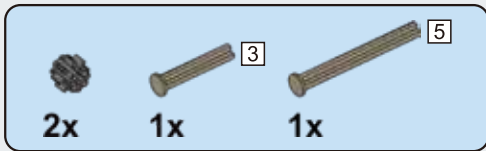

B23

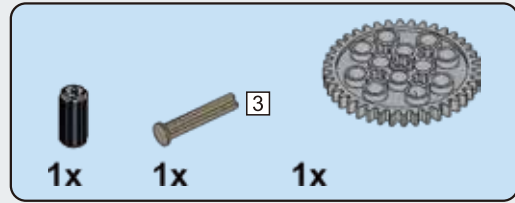
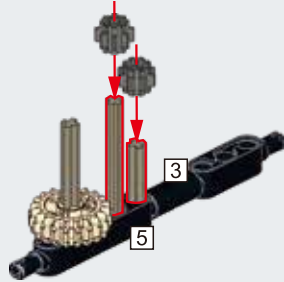

B24

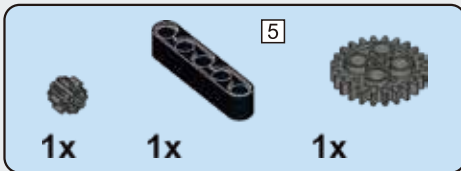
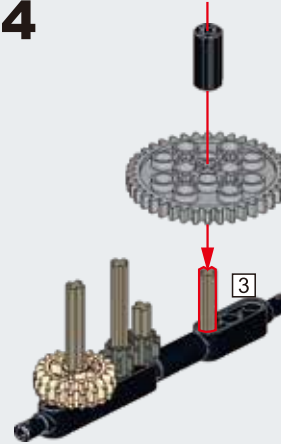

B25

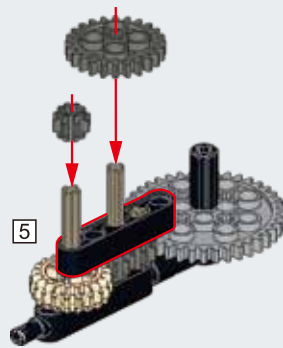

B26

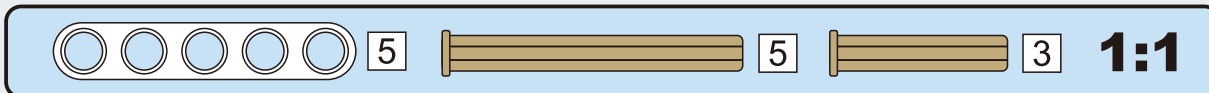

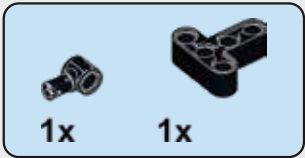

B27

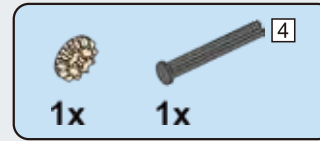
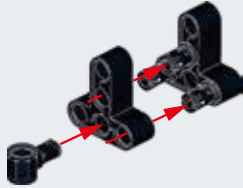

B28

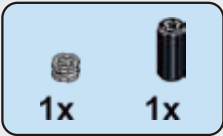
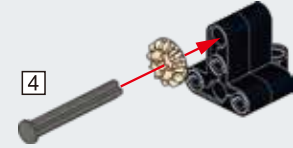
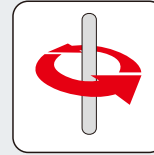

B29

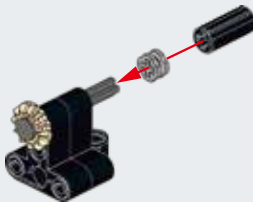

B30

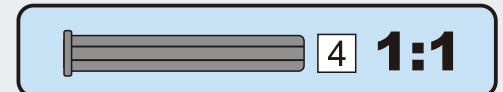
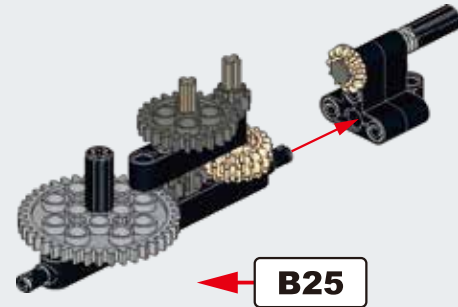

B31

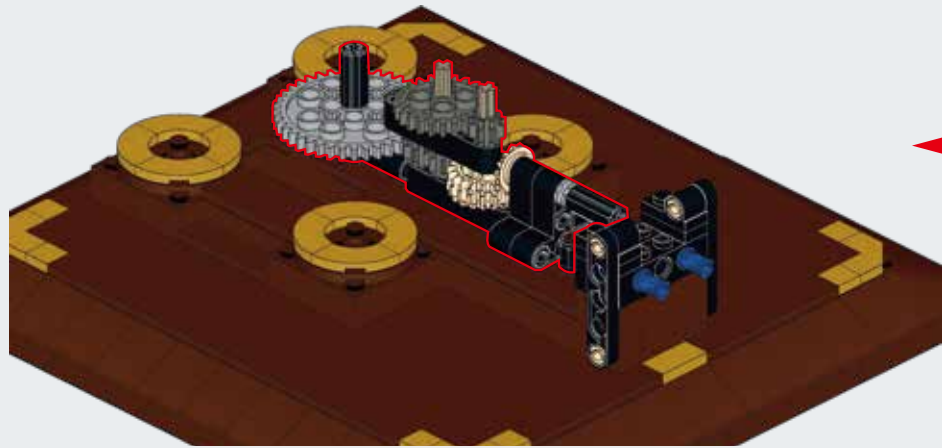

B20

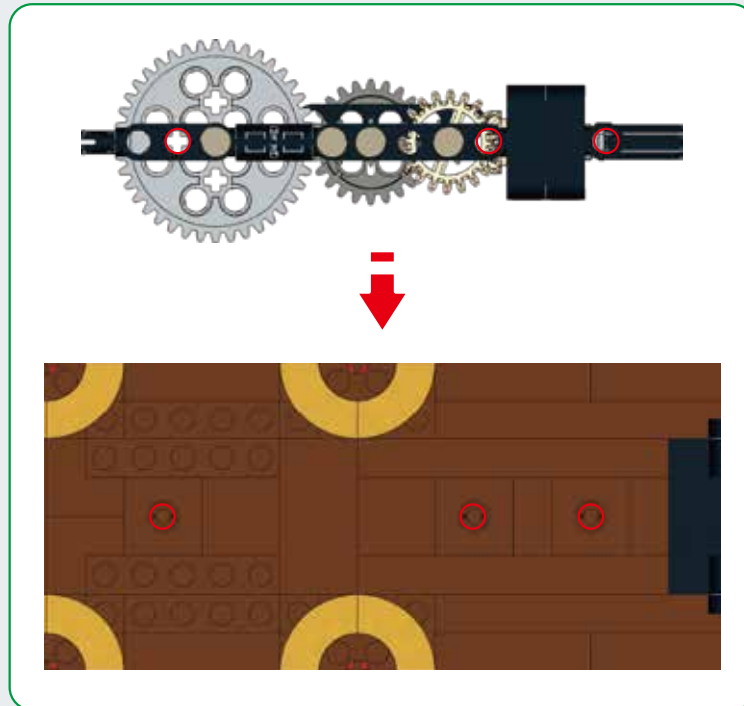

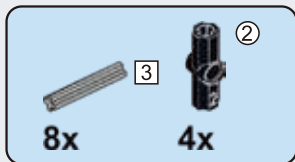

B32

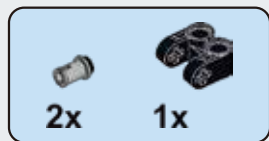
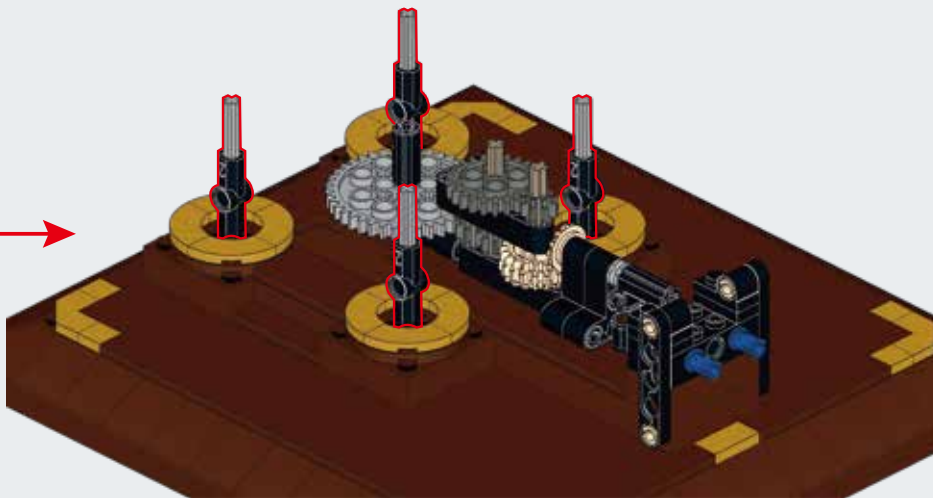
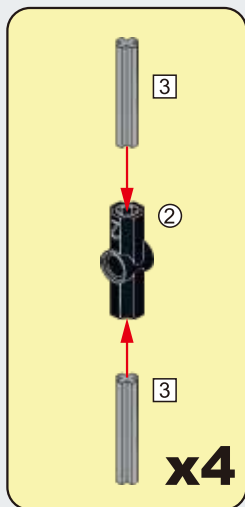

B33

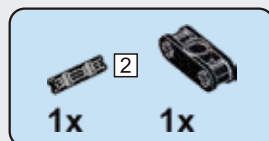

B34

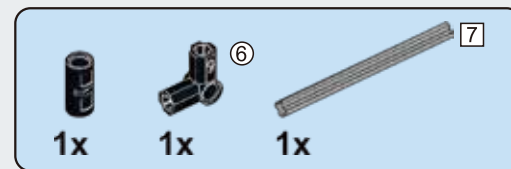
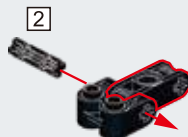

B35

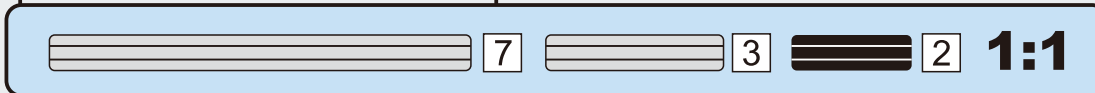
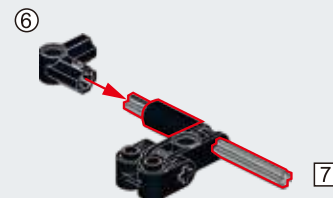



B36

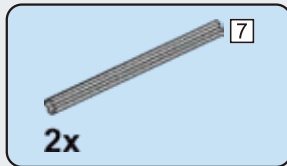
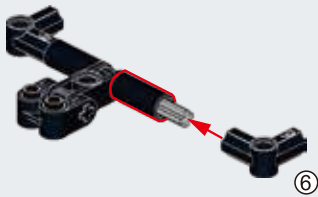

B37

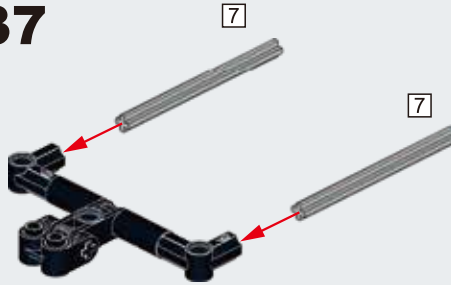

B38

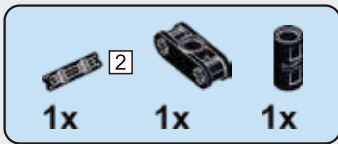
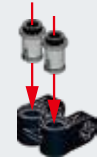

B39

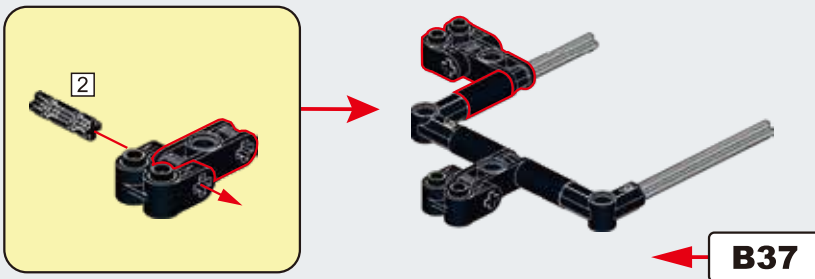

B40

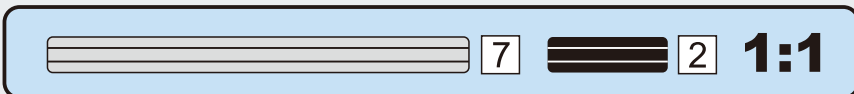
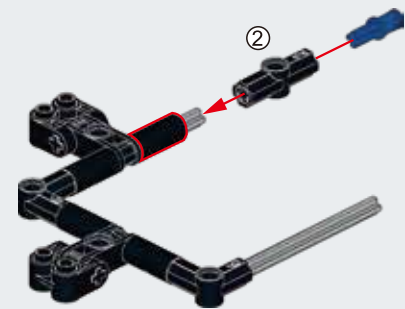

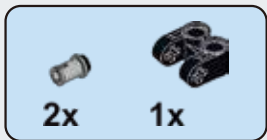

B41

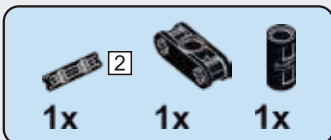

B42

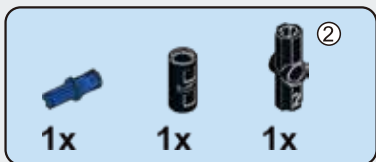
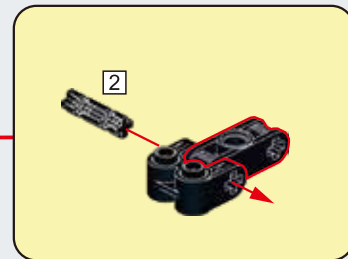
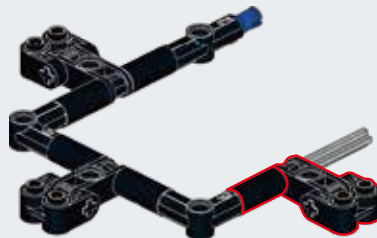

B43

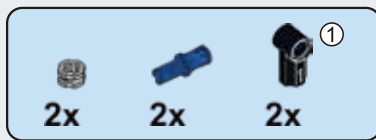
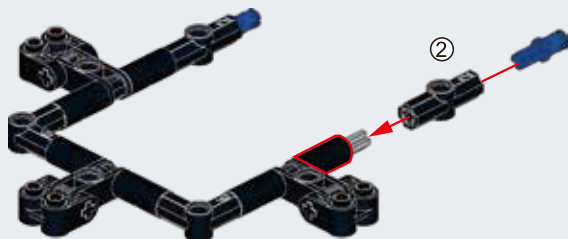

B44

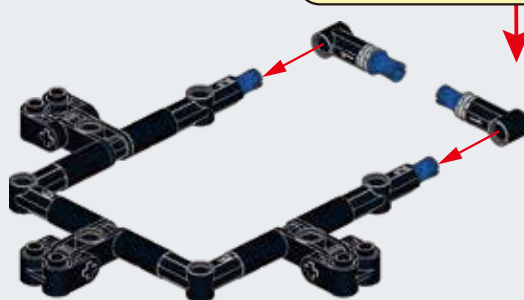
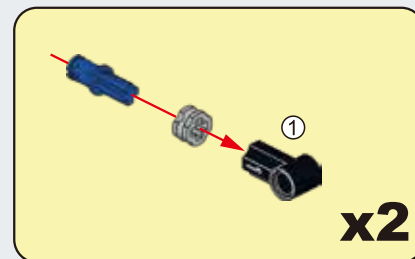



B45

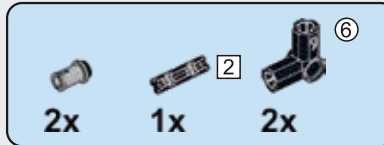
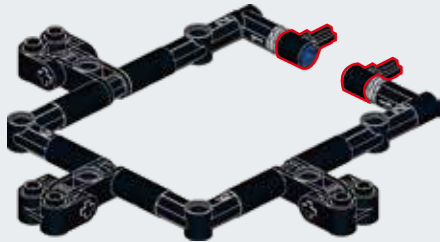

B46

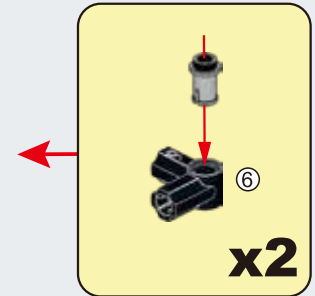
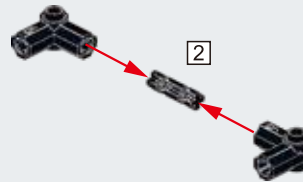

B47

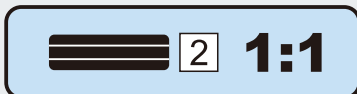
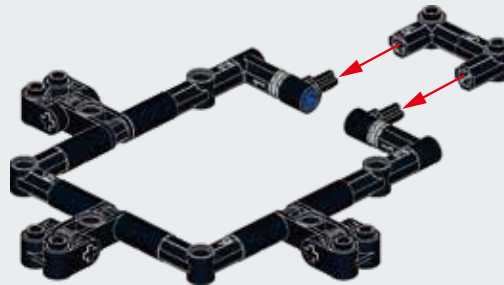

B48

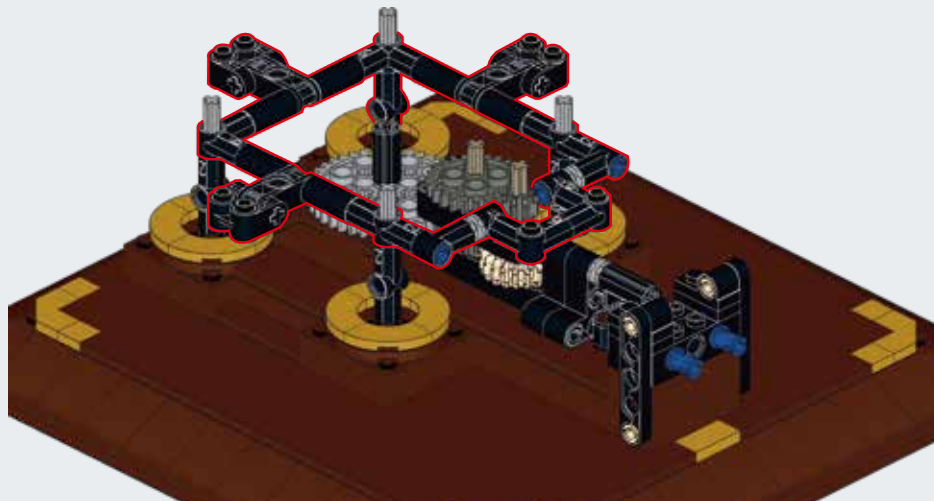
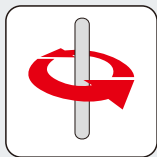

← **B32**

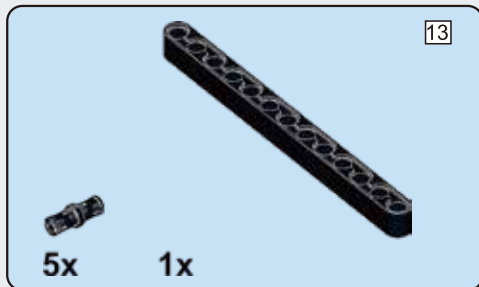

B49

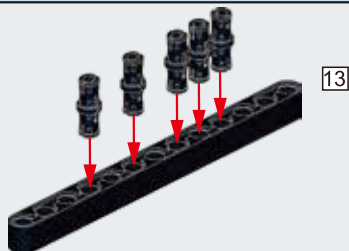

B50

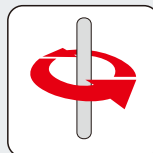
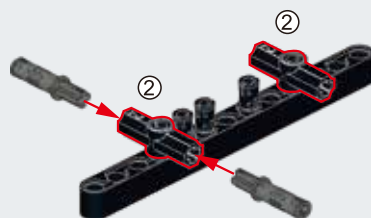

B51

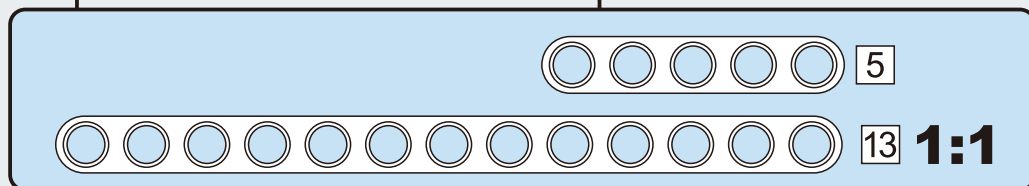
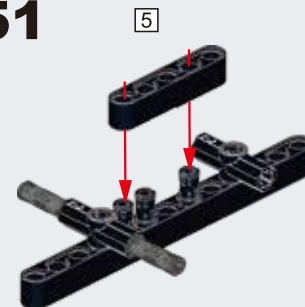

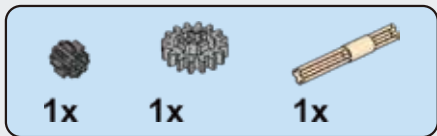

B52

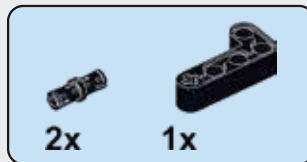
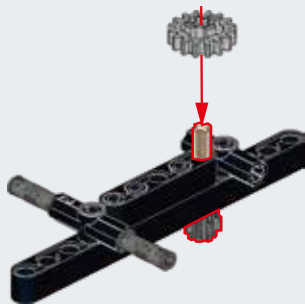

B53

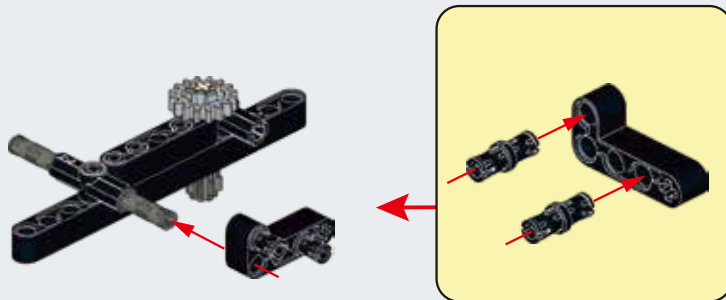

B54

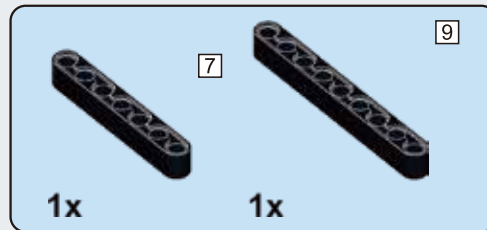
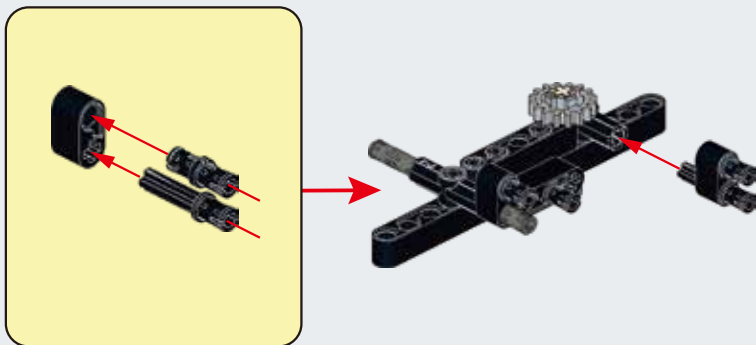

B55

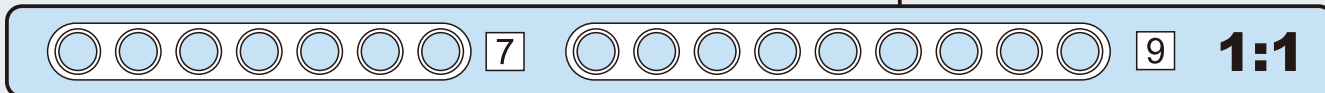
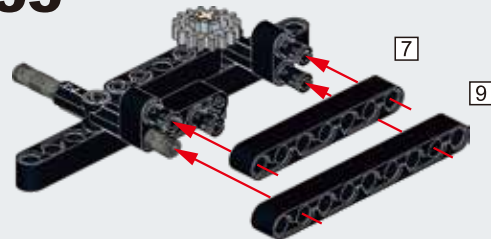



B56

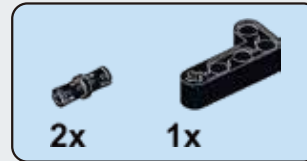
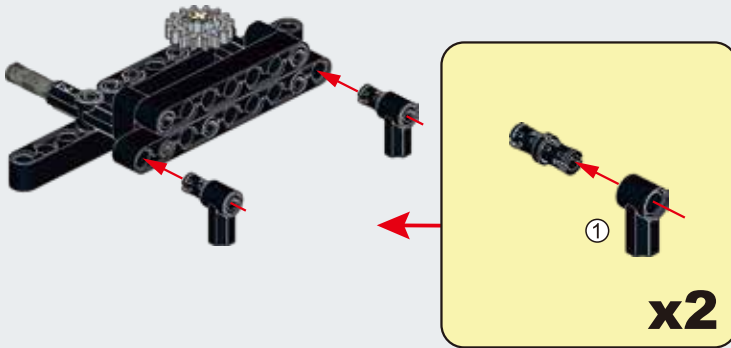

B57

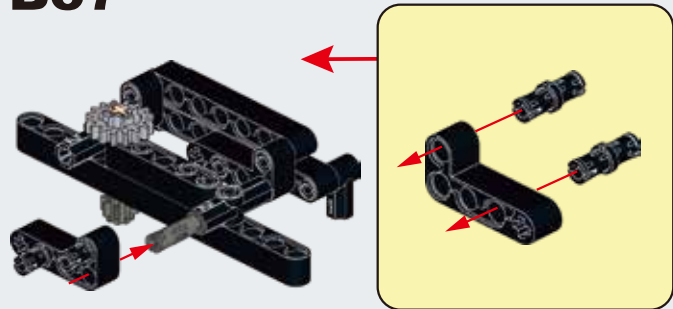
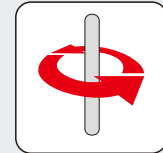

B58

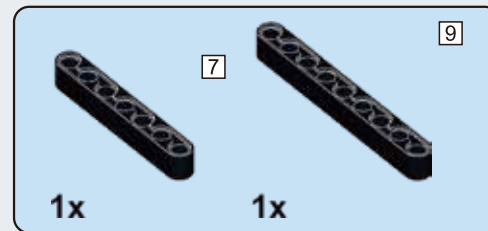
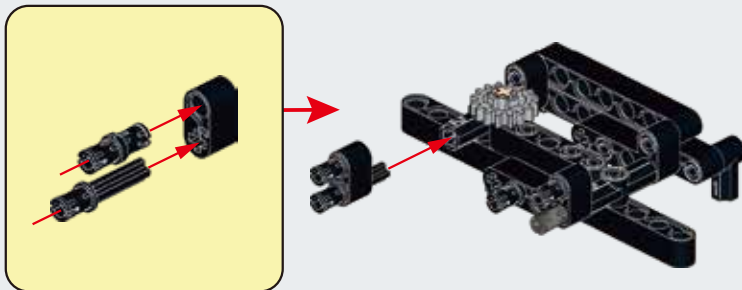

B59

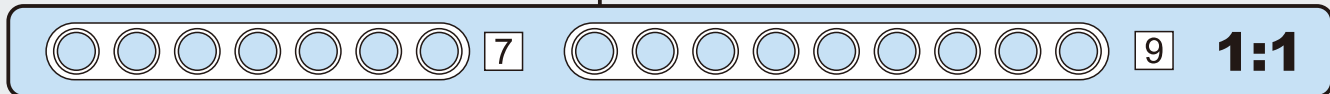
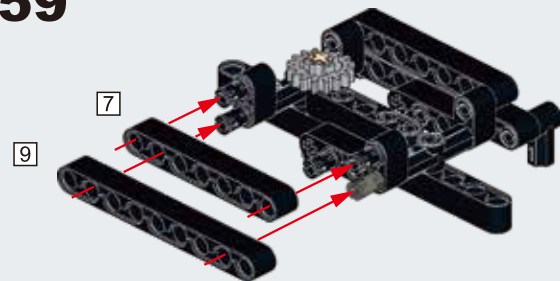



B60

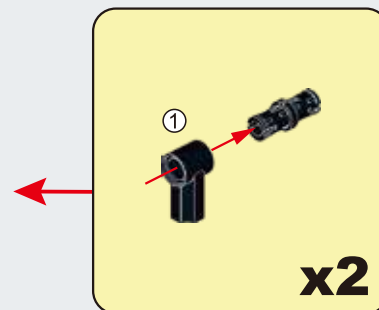
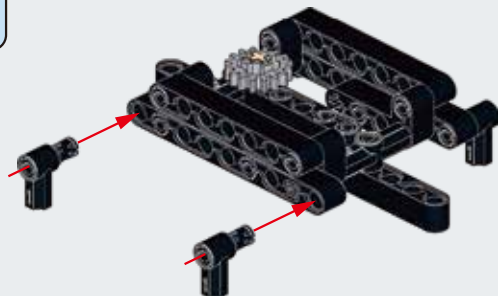

B61

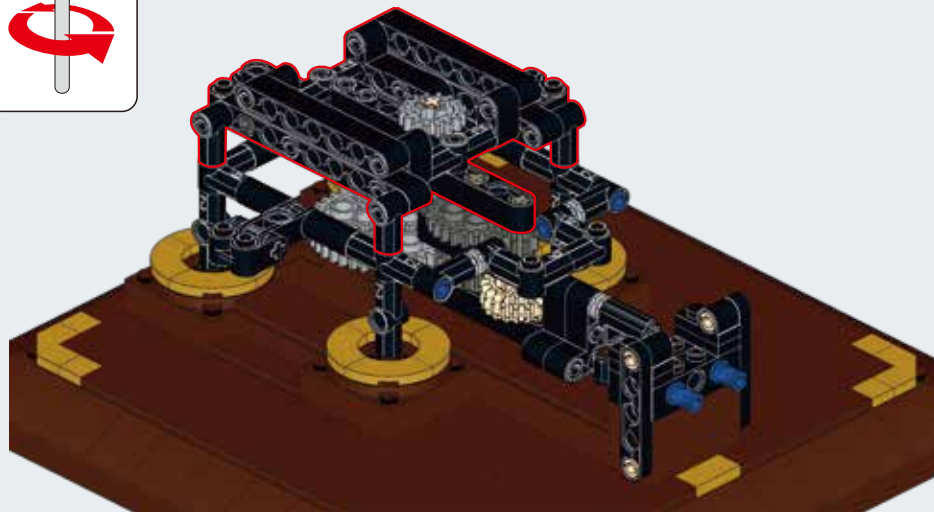
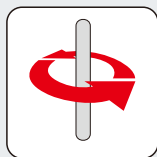

B48



B62

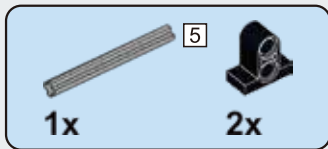
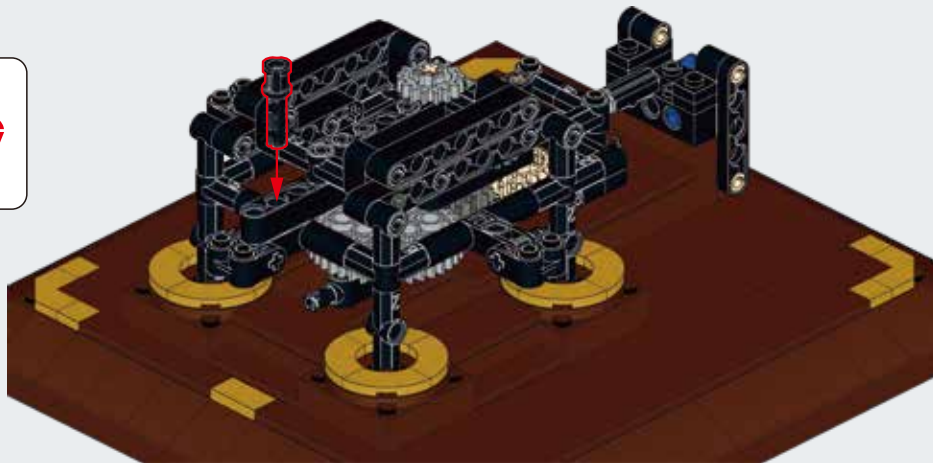
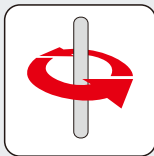

B63

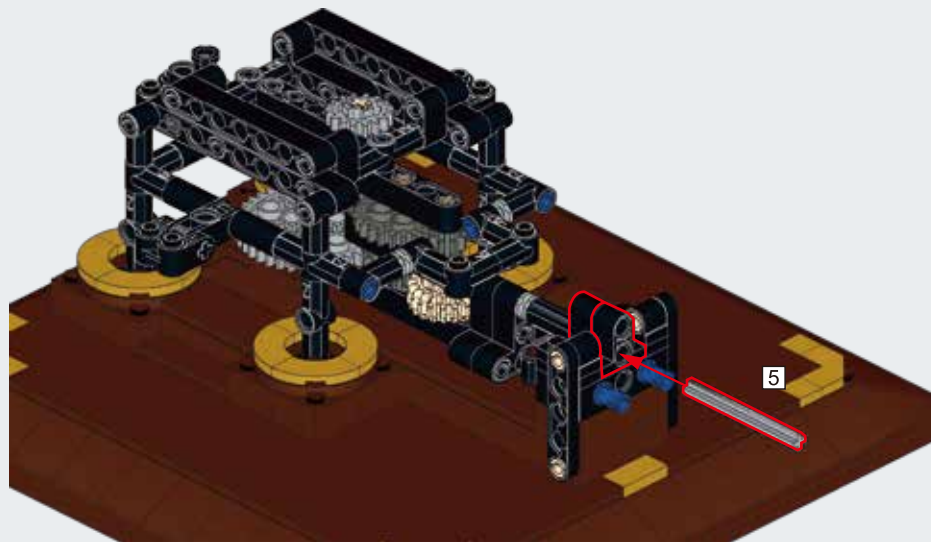
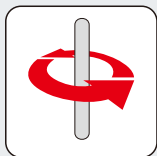



B64

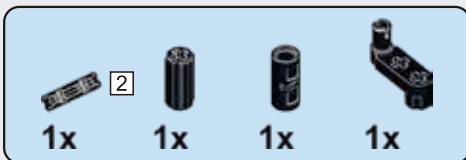
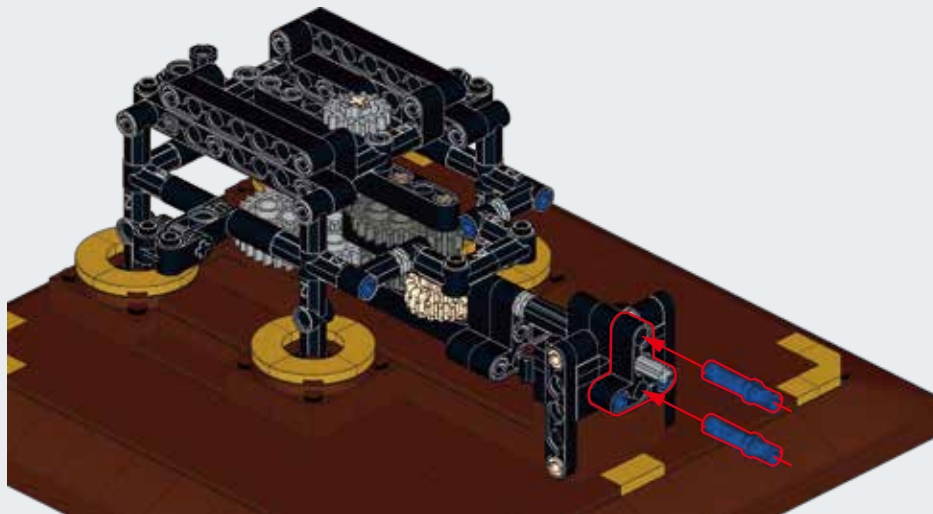

B65

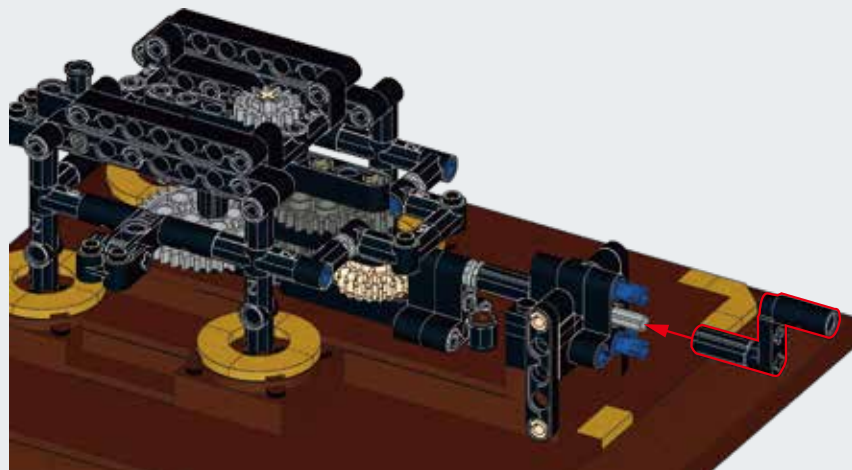
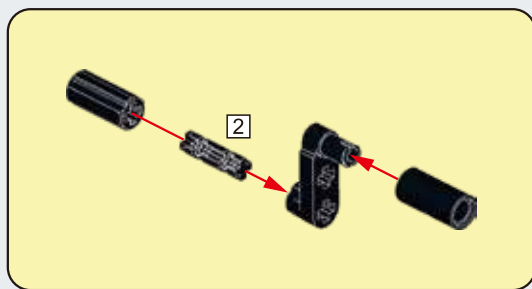

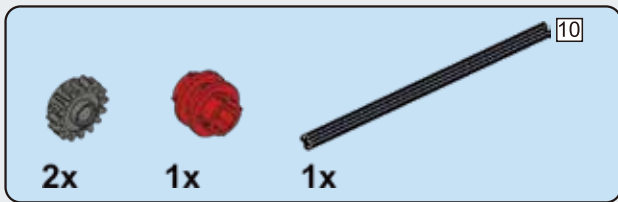

B66

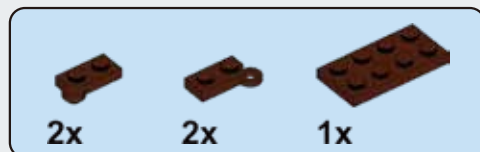
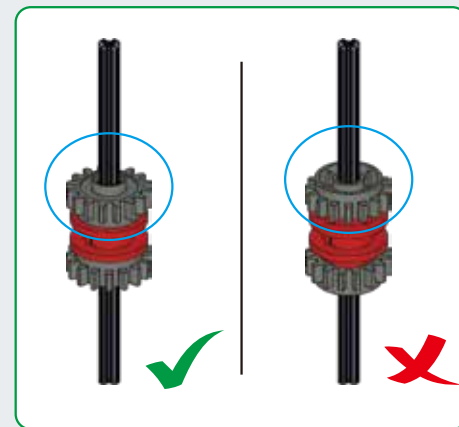
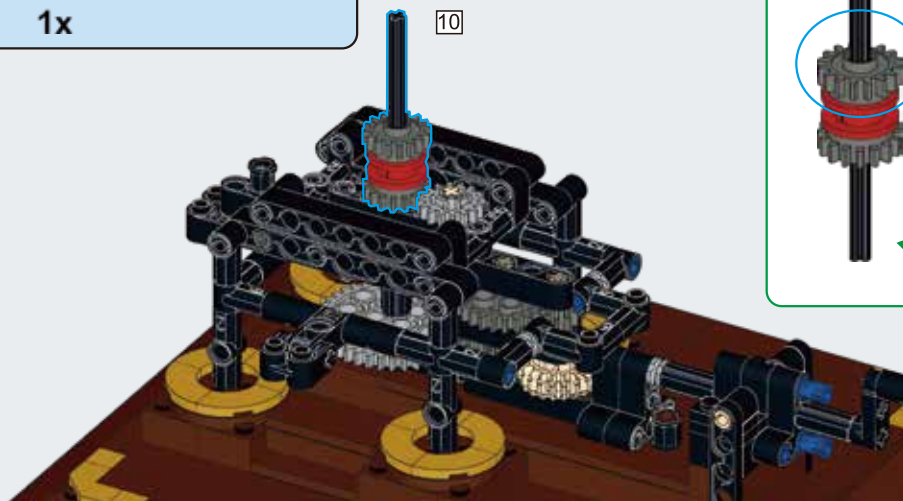

B67

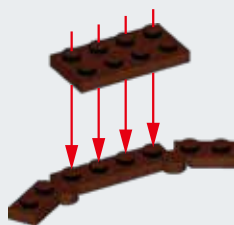
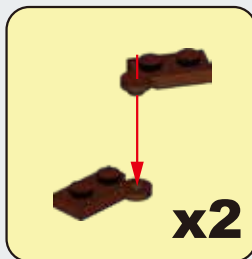

B68

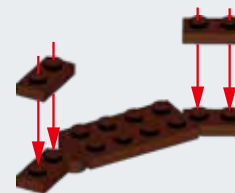

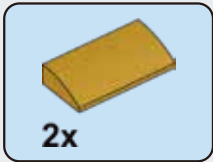

B69

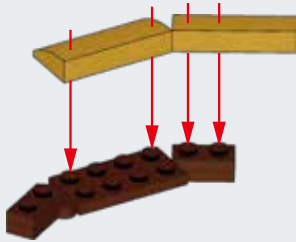

B70

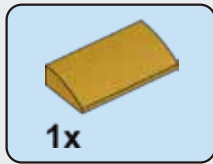
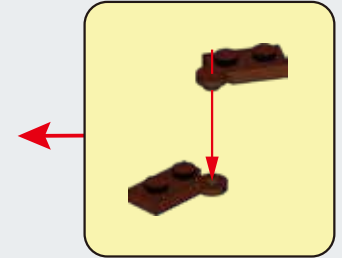
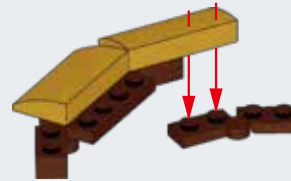

B71

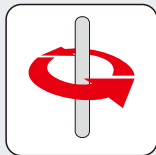

B72

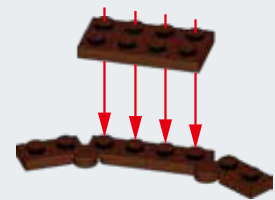
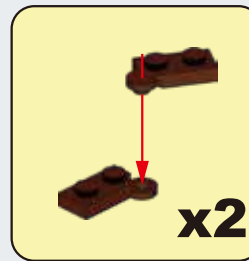



B73

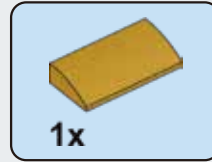
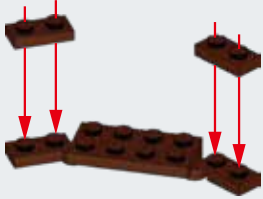

B74

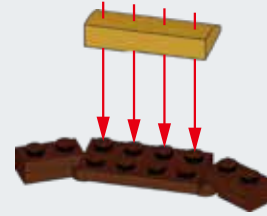

B75

B71

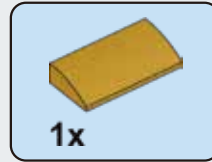
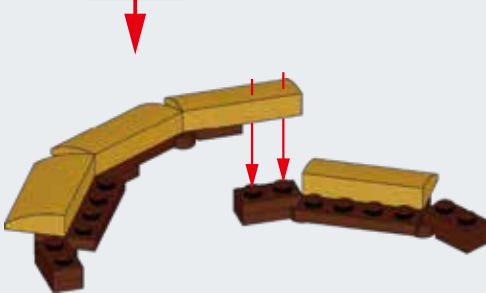

B76



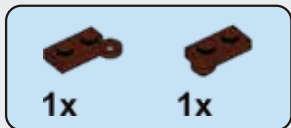

B77

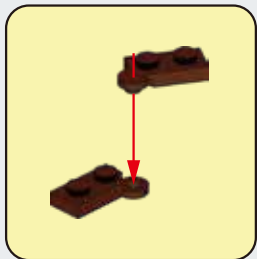

B78

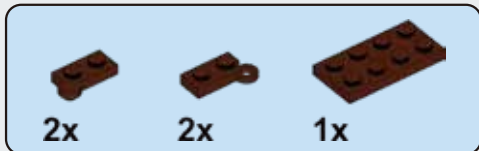

B79

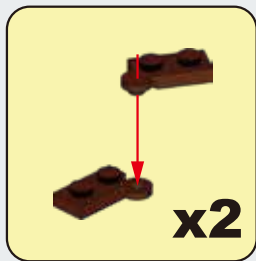

B80



CaDA[®]



en.doubleeagle-group.com

403ARC710040001

CaDA[®] MASTER

SOLAR SYSTEM



C71004

865PCS The Solar System



JK
Brickworks
Designer: JK Brickworks

