

HISTORY OF MEMORIAL HALL

Following the Civil War, The Harvard Corporation gave its official sanction to a group of distinguished and diverse Harvard alumni who petitioned the college to let them raise funds for a memorial to those Harvard graduates who fought for the United States Army and Navy. The new committee of fifty Alumni suggested that the proposed memorial take the form of a building, one that would not only testify to the heroism of those who fell but also meet the college's urgent and practical needs for a theatre and a gathering space for alumni.

The committee proposed a Hall of Alumni in which students and graduates might be inspired by the pictured and sculptured presence of her founders, benefactors, faculty, presidents and most distinguished sons. The vision was a compelling one: between 1865 and 1868, members of the committee collected a staggering \$370,000, a sum equal to one-twelfth of the endowment of the University.

At the same time, Charles Sanders, who was a member of the class of 1802 and who had held the position of “college steward” from 1827-1831, had bequeathed to the College \$40,000 for the purpose of erecting “a hall or theatre to be used on Commencement days, Class days, Exhibition days, days of the meetings of the society of Alumni, or any other public occasion connected with the College, whether literary or festive.” The two projects were thus joined and each helped to make the other feasible.

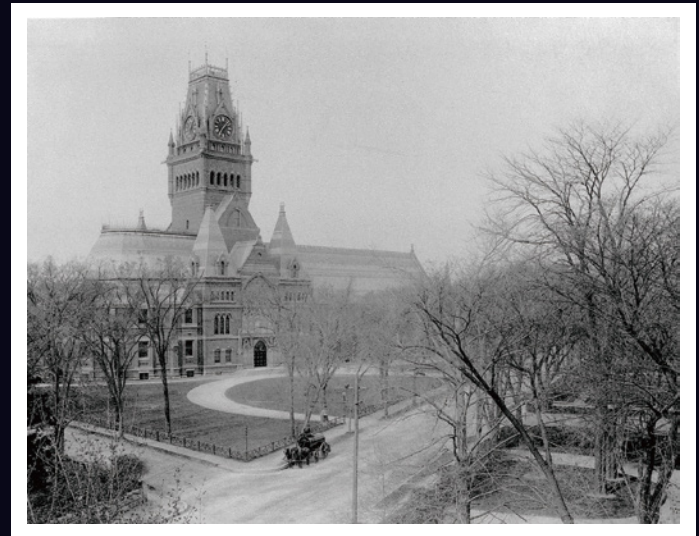

HISTORY OF MEMORIAL HALL

The site chosen for the new memorial building was that referred to as The Delta because of its triangular shape, bounded on three sides by Cambridge, Kirkland and Quincy streets. The Memorial Hall Building Committee purchased Jarvis Field (now the Law school) in order to provide a new location for the playing field that had previously occupied the Delta.

In December of 1865, the committee invited several prominent architects (all Harvard alumni) to submit designs in competition, coding them by number to ensure an impartial choice. The design of William Robert Ware, class of 1852, and Henry Van Brunt, class of 1854, was selected though it was much refined in the months and years to come. The building received its formal name, Memorial Hall, in September of 1870. A month later its cornerstone was laid. It represented a remarkable achievement by a group of committed volunteers, from conception to cornerstone in just five years. A ceremony was held on October 6, 1870, to lay the Memorial Hall cornerstone.

In 1874, less than four year's time, the hall and the transept were dedicated for use. Sanders Theatre was substantially completed in the spring of 1875 but not used until Commencement exercises in the spring of 1876. The tower was completed in 1877.

It was in 1878 that the thirteen-year effort to honor Harvard's fallen soldiers and transform the lives of undergraduates finally culminated with the official turn over of the building to the University.

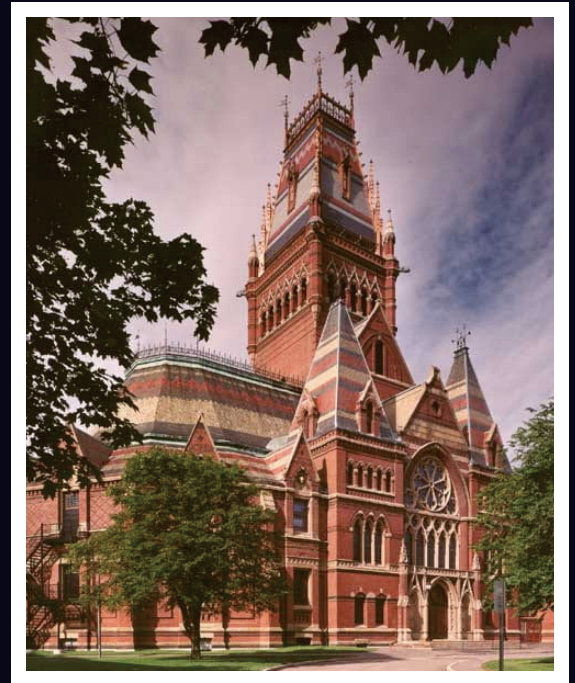

哈佛纪念堂历史

内战结束后，哈佛公司正式批准了一群杰出而多元化的哈佛校友，他们向学院请愿，让他们筹集资金，纪念那些为美国陆军和海军而战的哈佛毕业生。由五十名校友组成的新委员会建议，拟议的纪念馆应采用建筑物的形式，不仅要证明那些倒下的人的英雄主义，还要满足学院对剧院和校友聚会空间的迫切和实际需求。

委员会提议建立一个校友大厅，能够让学生和毕业生受到创始人，捐助者，教师，校长和最杰出的学子们的图片和雕塑的启发。这个愿景令人信服：在1865年至1868年间，委员会成员筹集了惊人的370万美元，相当于大学捐赠基金的十二分之一。

与此同时，查尔斯·桑德斯 (Charles Sanders) 是1802届毕业生，曾在1827年至1831年期间担任“学院管家”的职位，他向学院遗赠了40,000美元，用于建立“一个大厅或剧院，用于毕业典礼，上课日，展览日，校友会会议日，或与学院有关的任何其他公共场合，无论是文学的还是节日的。因此，这两个项目被合并，每个项目都有助于使另一个项目可行。

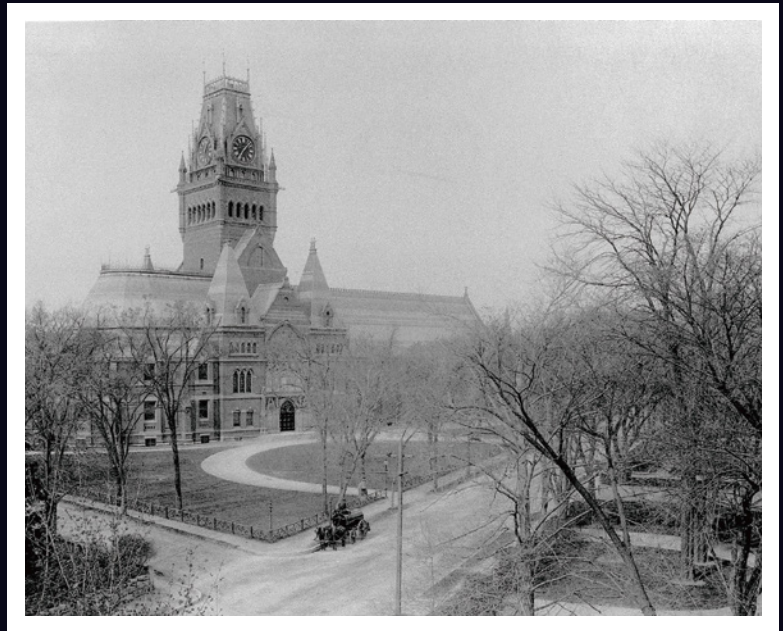

哈佛纪念堂历史

为新纪念建筑选择的地点被称为三角洲，因为它的三角形形状，三面以剑桥，柯克兰和昆西街道为界。纪念馆建筑委员会购买了贾维斯球场（现为法学院），以便为以前占据三角洲的运动场提供新的位置。

1865年12月，委员会邀请了几位著名建筑师（均为哈佛校友）在竞赛中提交设计，并按编号进行编码以确保公正的选择。1854届的威廉·罗伯特·韦尔（William Robert Ware）和1870届的亨利·范·布伦特（Henry Van Brunt）的设计被选中，尽管在接下来的几个月和几年里，它得到了很大的改进。该建筑于1870年9月获得正式名称，纪念馆。一个月后，它奠定了基石。它代表了一群忠诚的志愿者在短短五年内从概念到基石的非凡成就。1870年10月6日举行了纪念馆奠基仪式。

1874年，不到四年的时间，大厅和耳堂就被投入于使用。桑德斯剧院于1875年春季基本完工，但直到1876年春季的毕业典礼才使用。该塔于1877年完工。

1878年，为纪念哈佛阵亡士兵和改变本科生的生活而进行的十三年努力，最终以大楼正式移交给大学而告终。

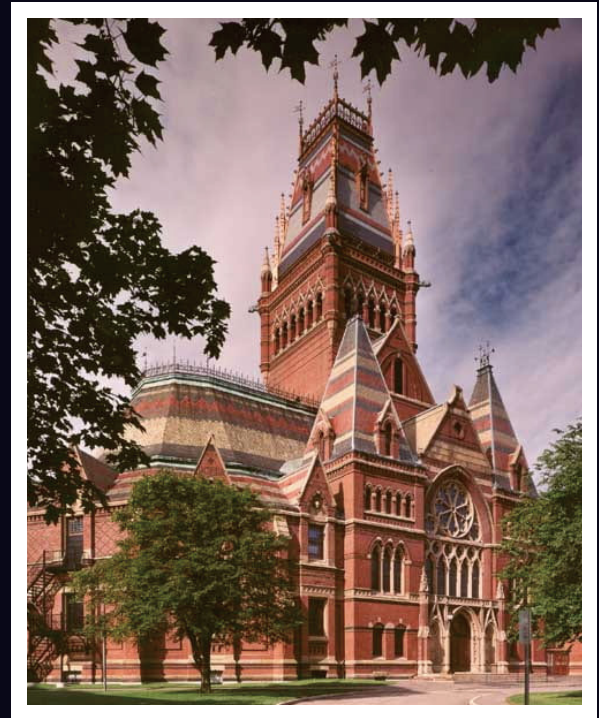

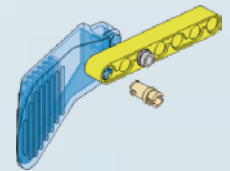
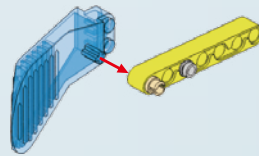
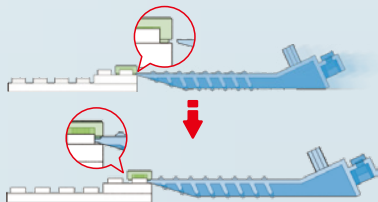
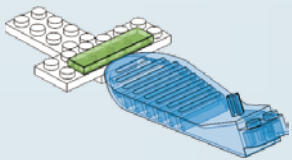
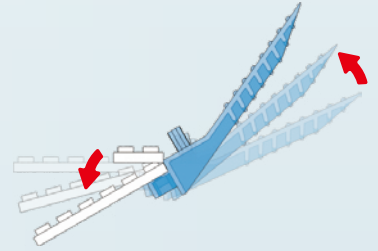
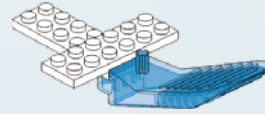
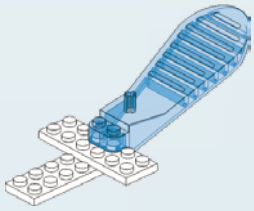

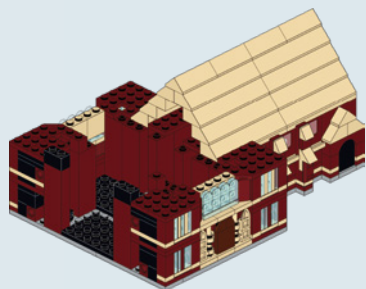

A

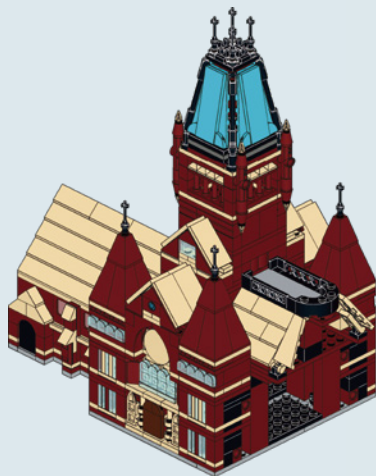

B



C

A

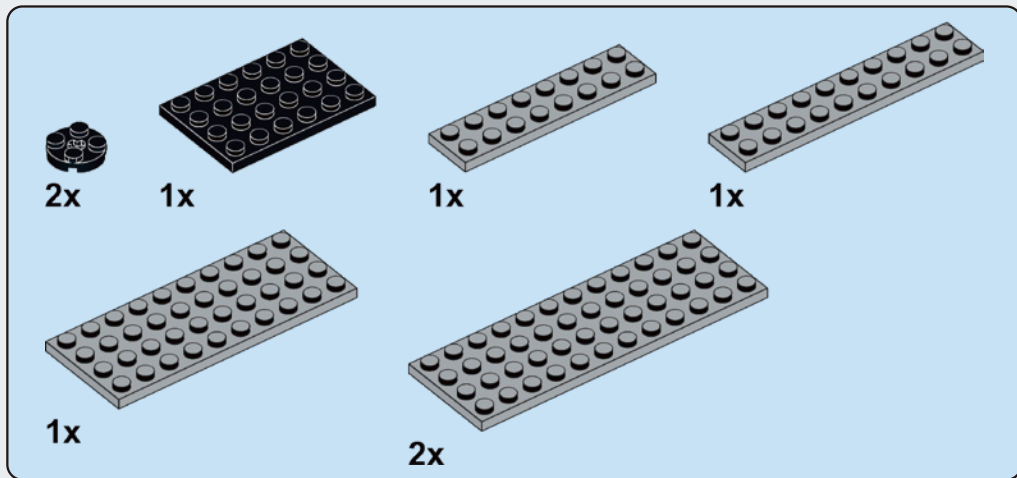
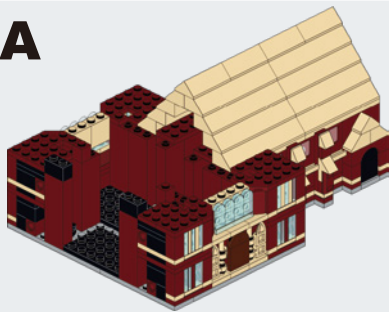

A1

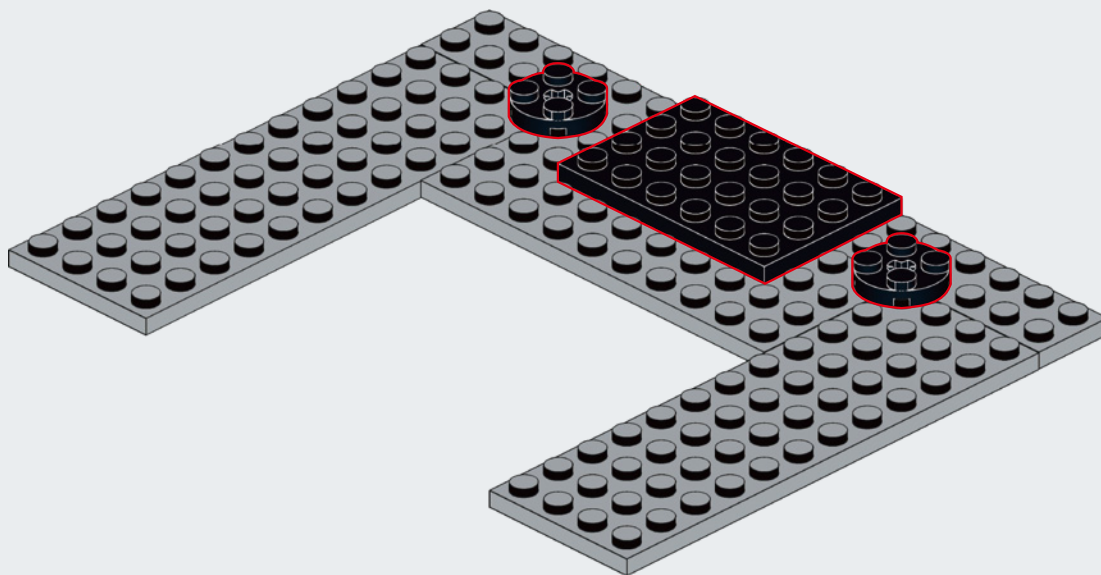

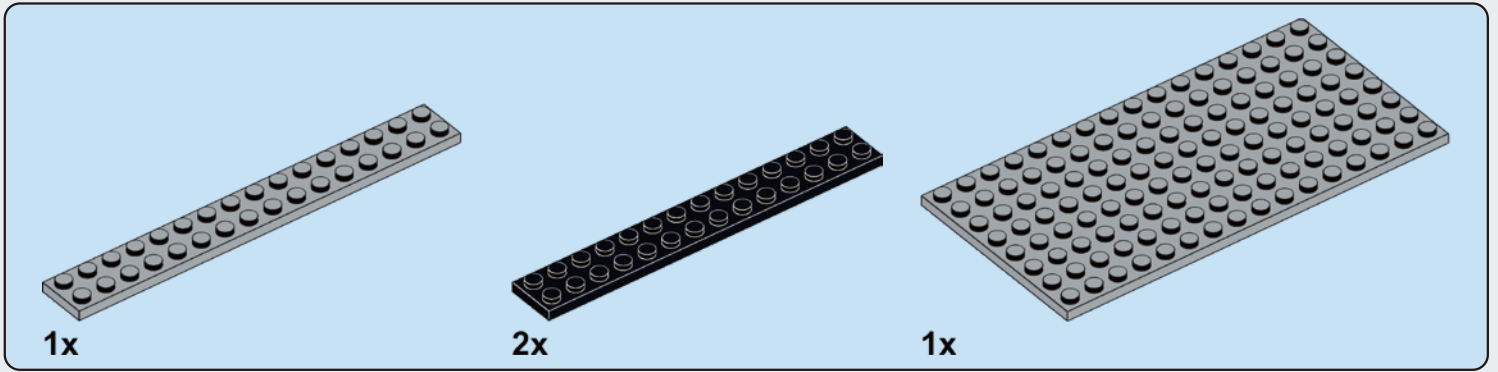

A2

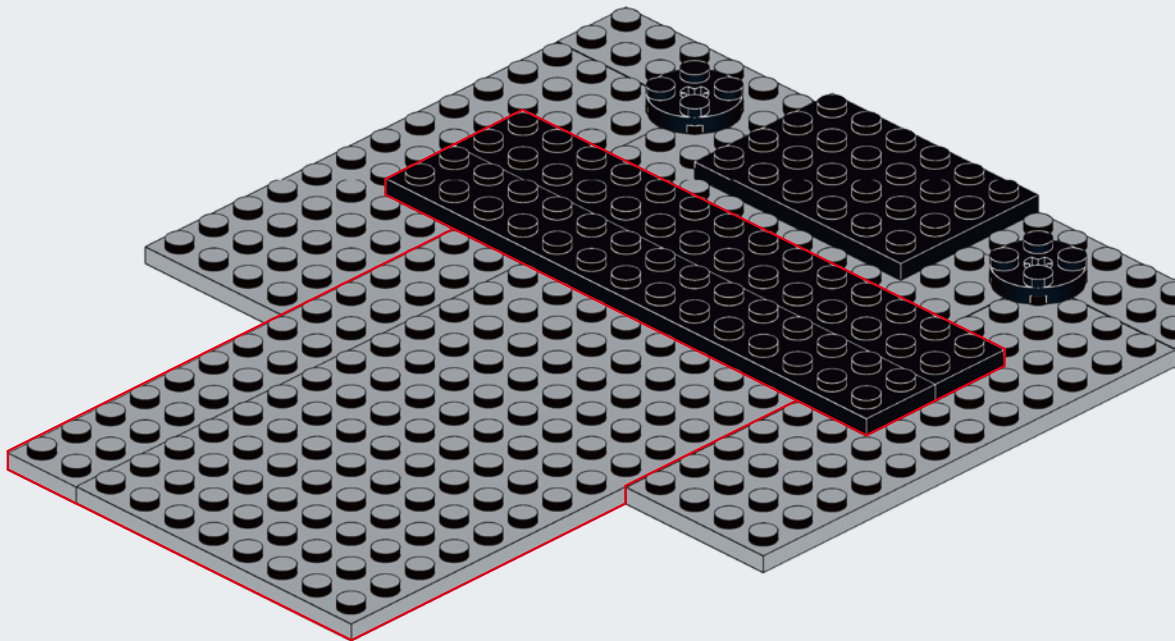



A3

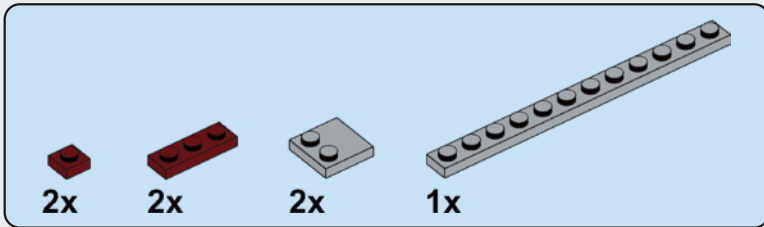
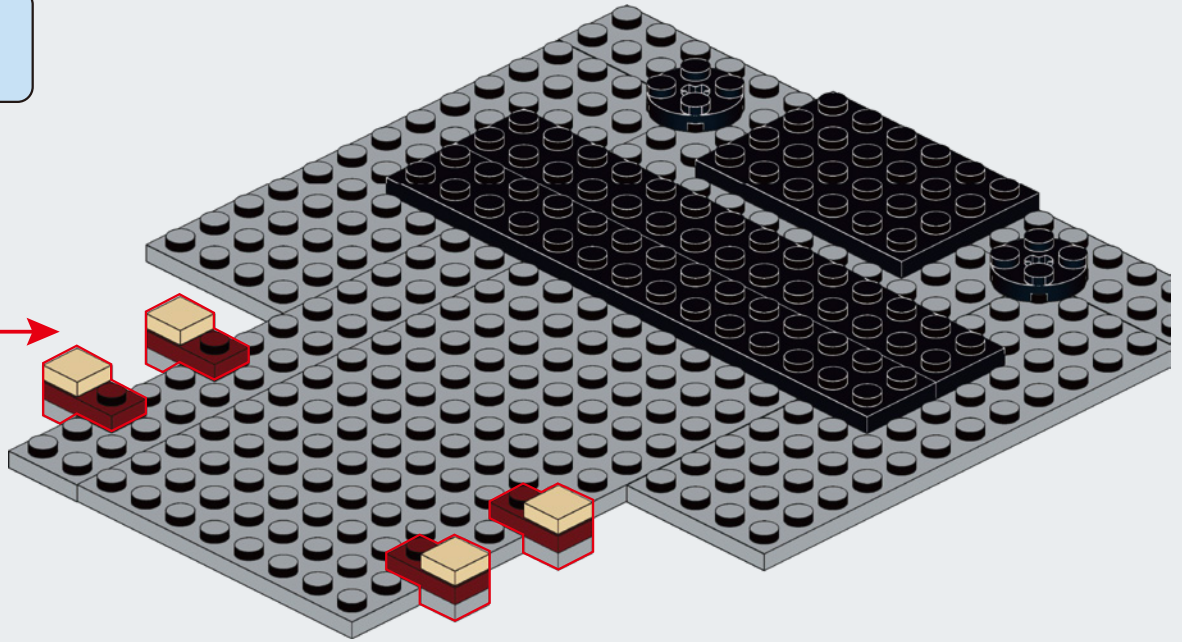
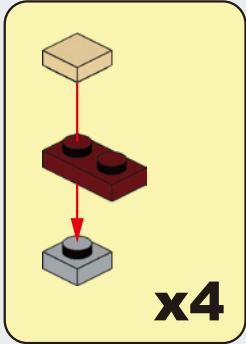

A4

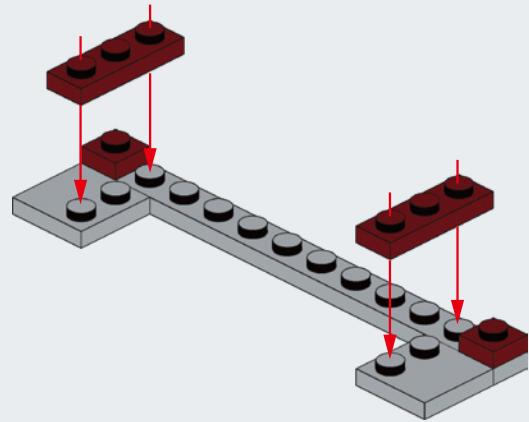

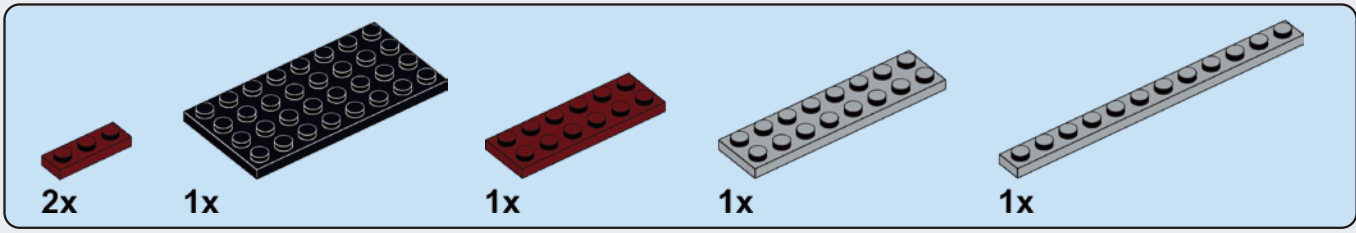

A5

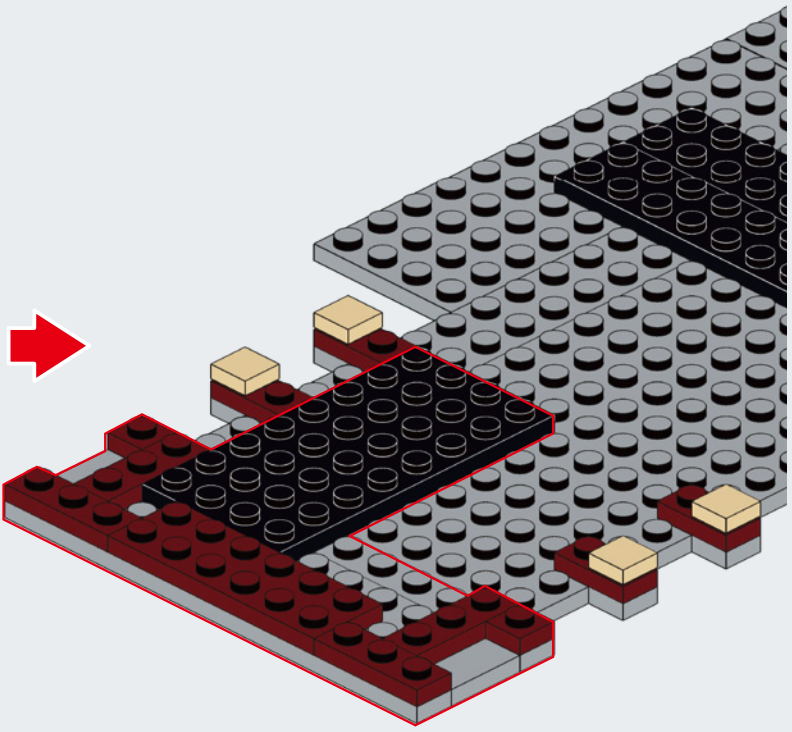
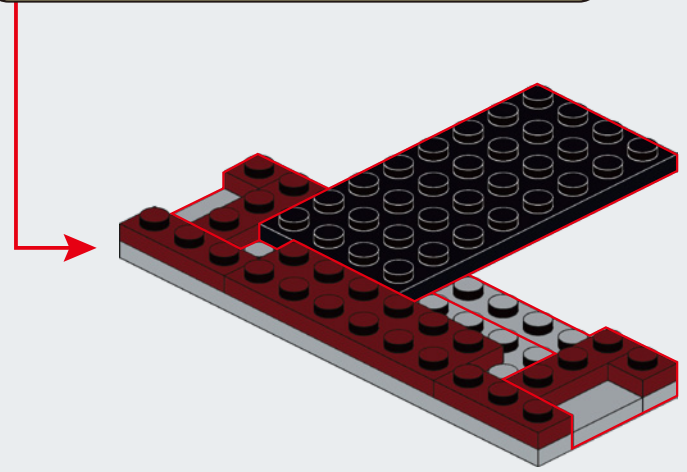
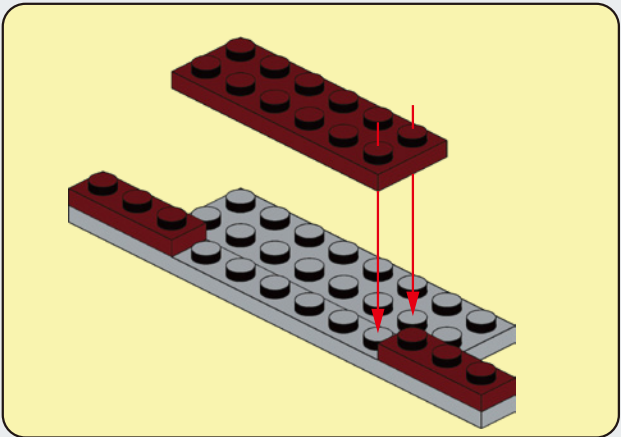

A4

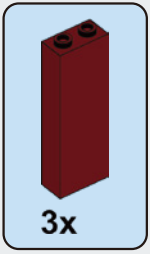

A6

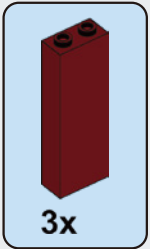
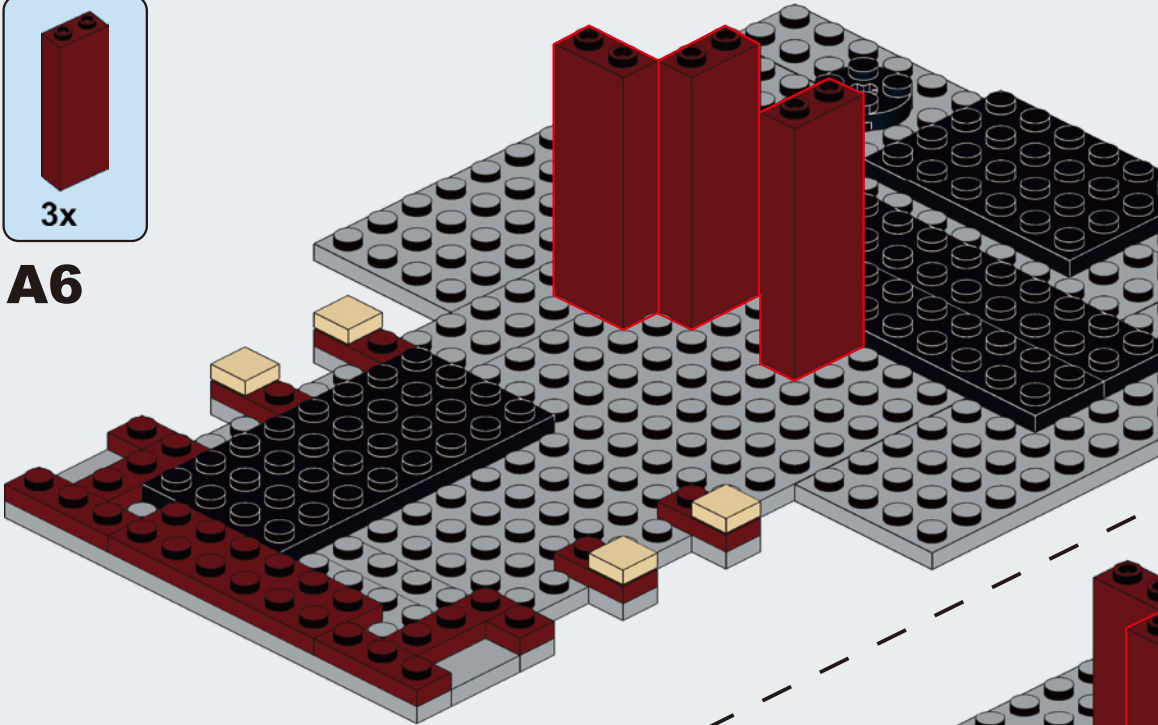

A7

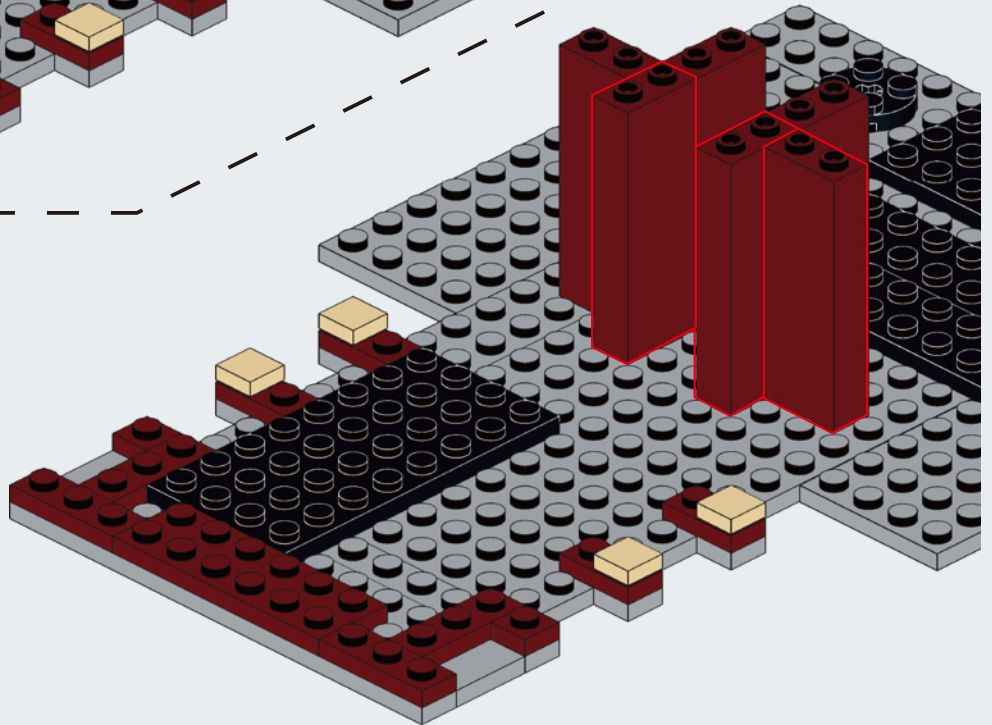

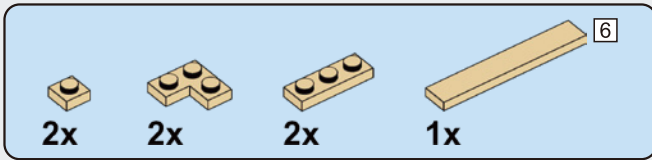

A8

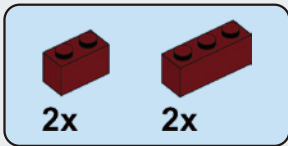
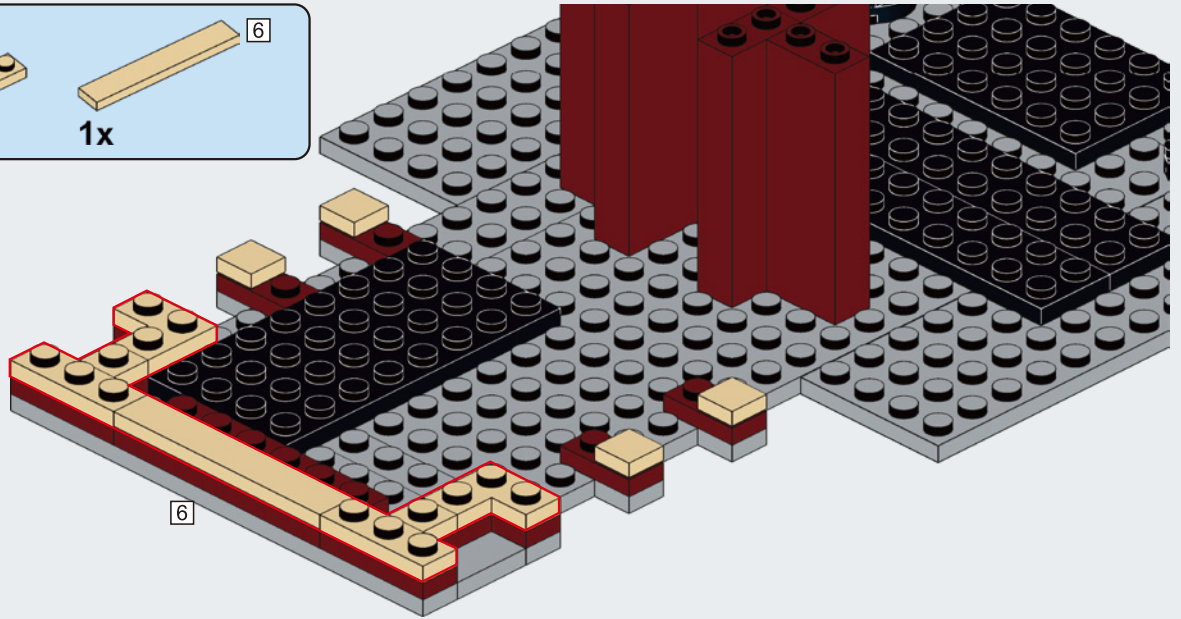

A9

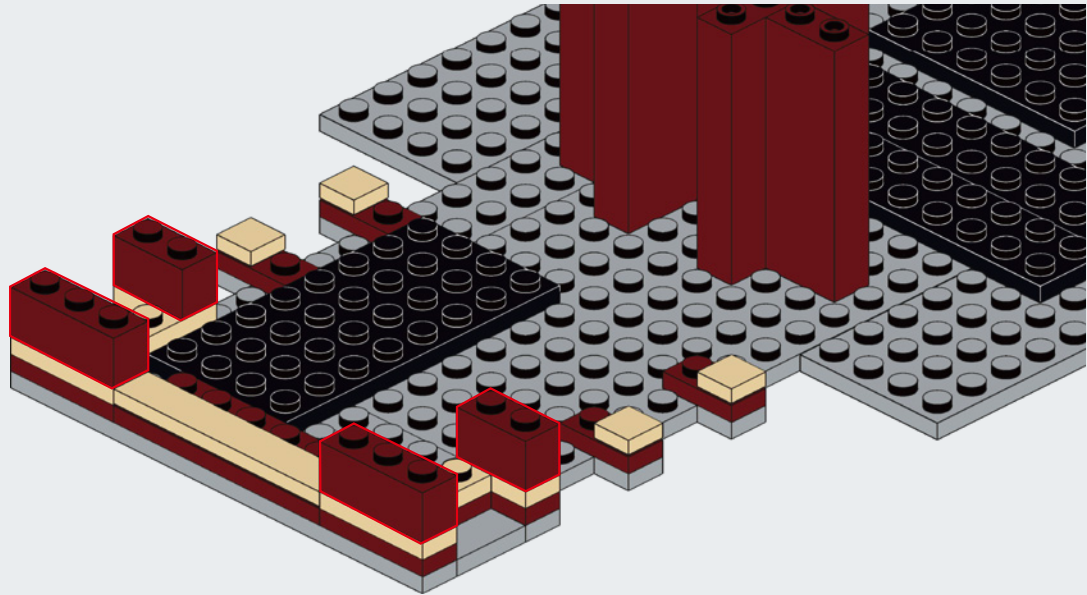

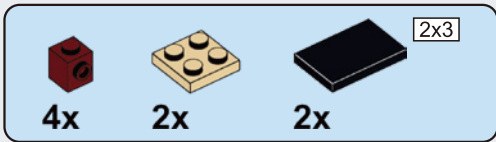

A10

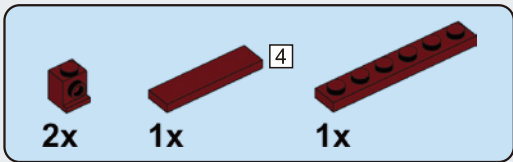
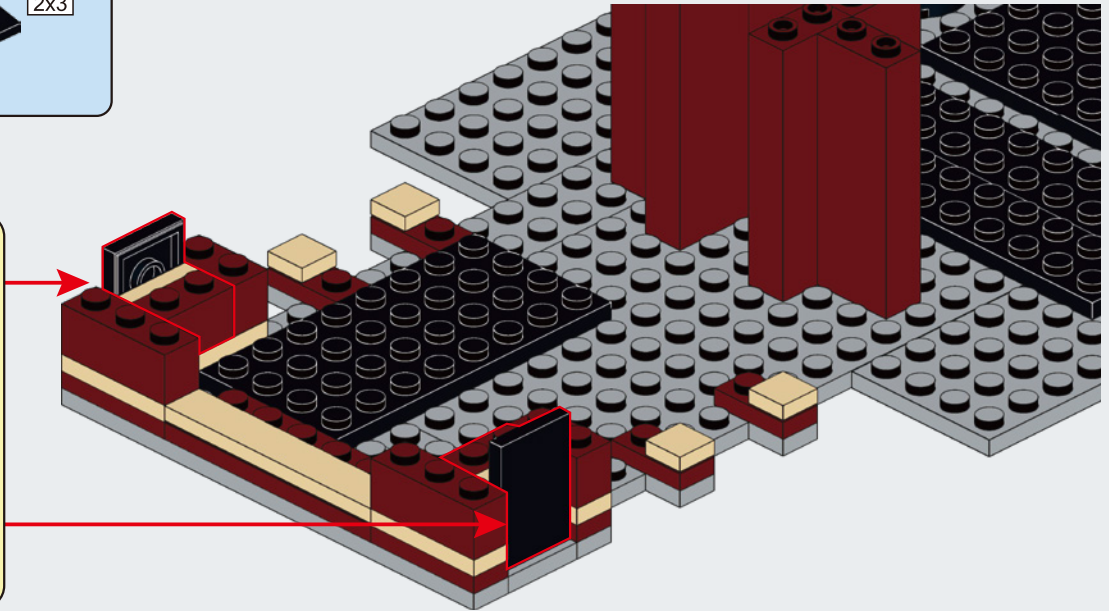
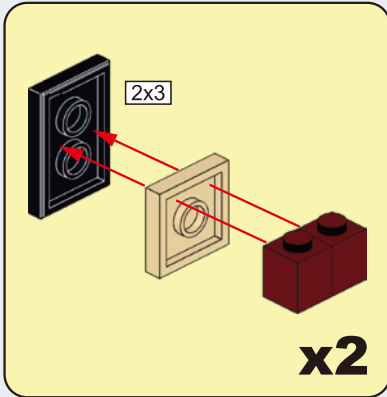

A11

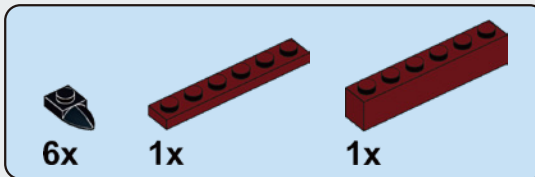
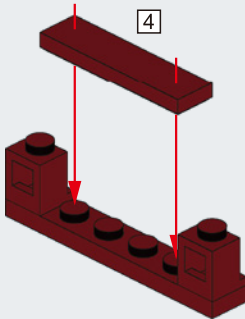

A12

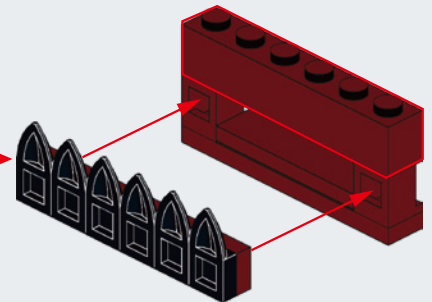
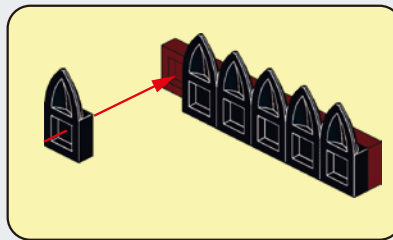

A13

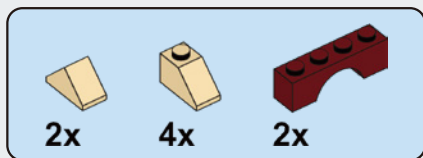
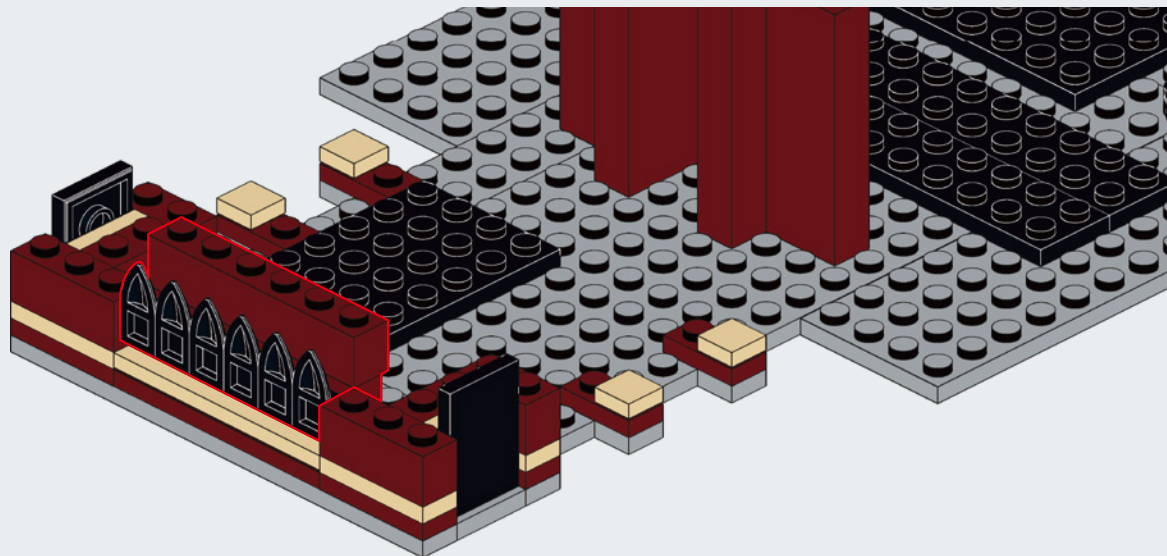

A14

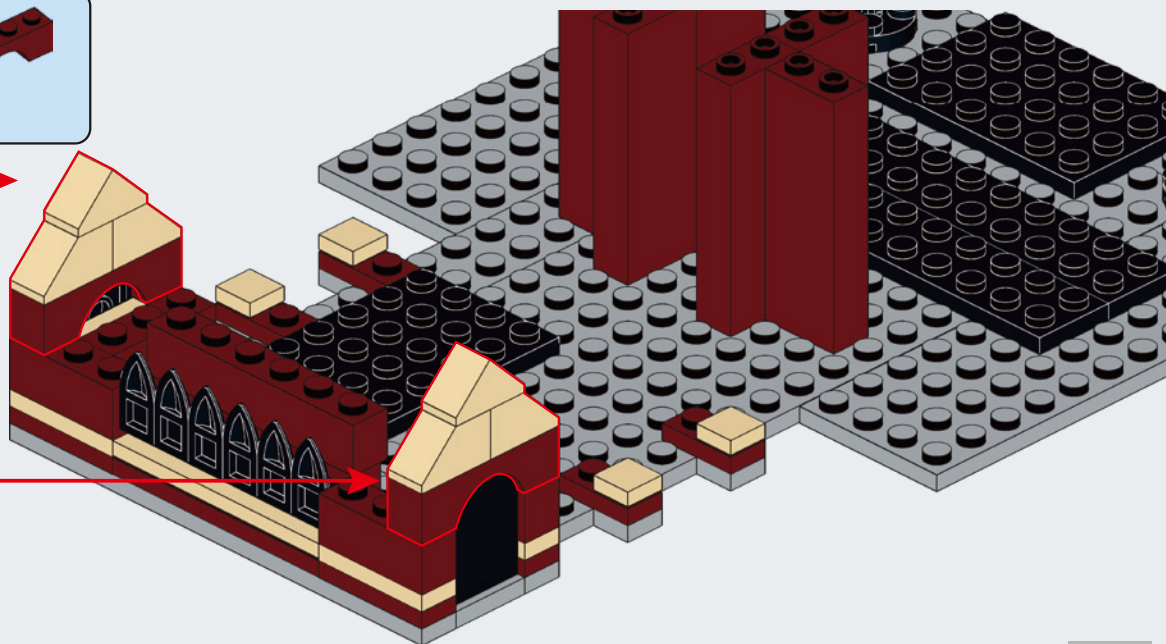
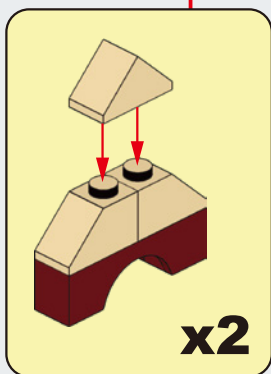

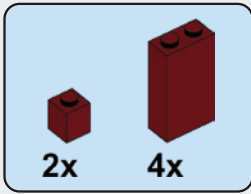

A15

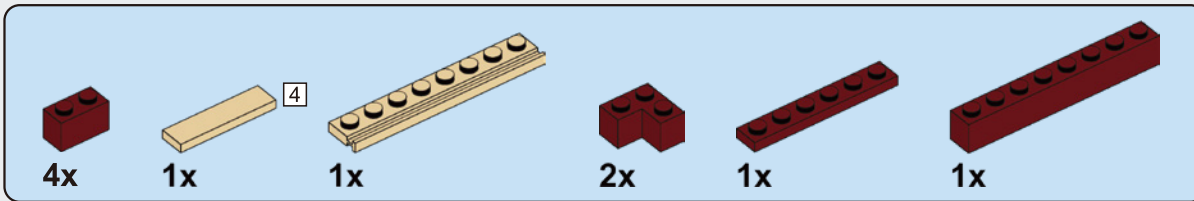
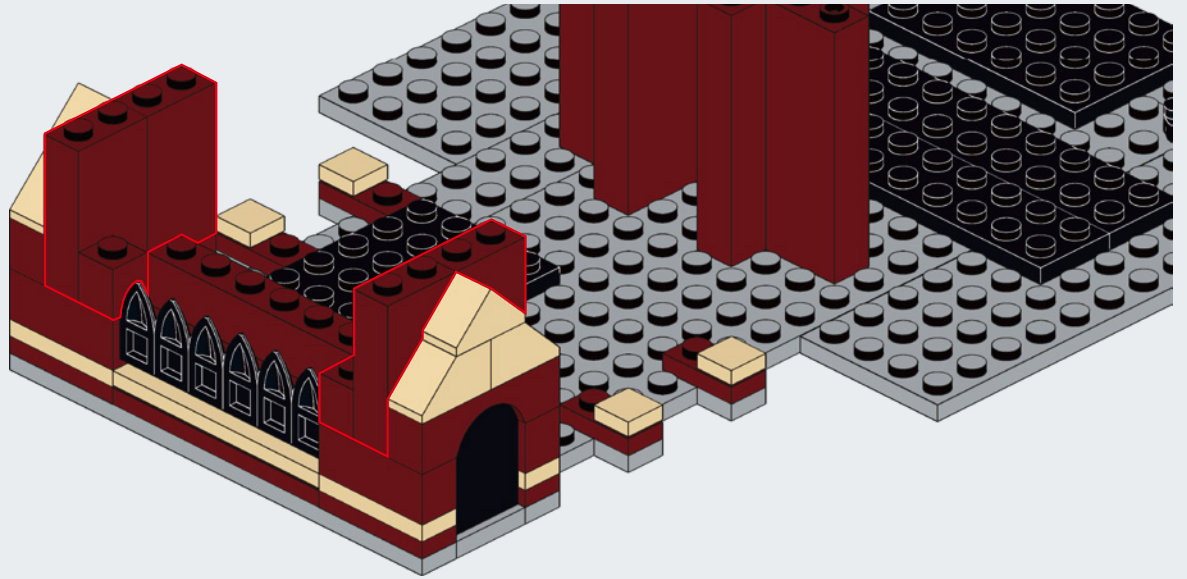

A16

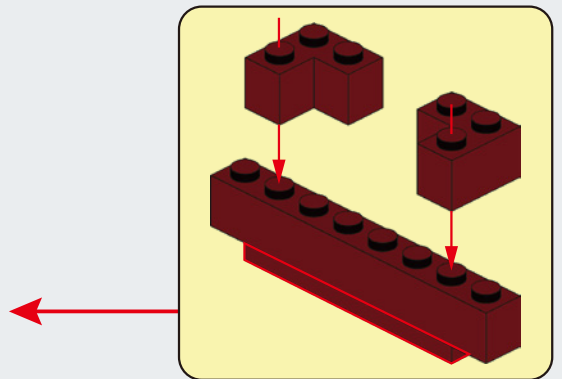
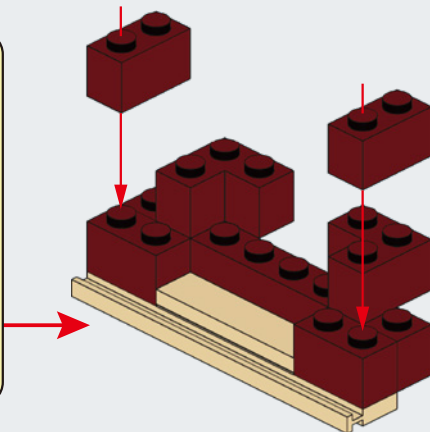
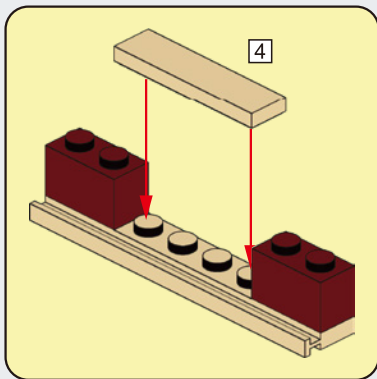

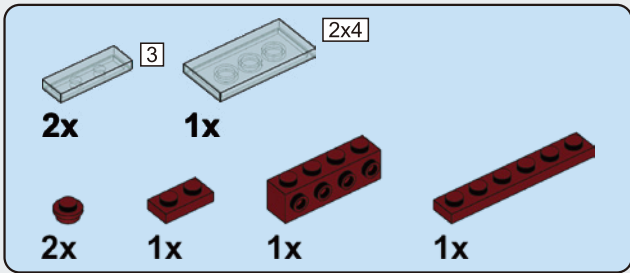

A17

65 67

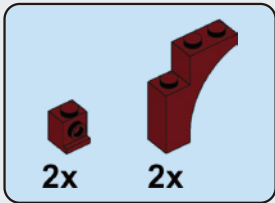
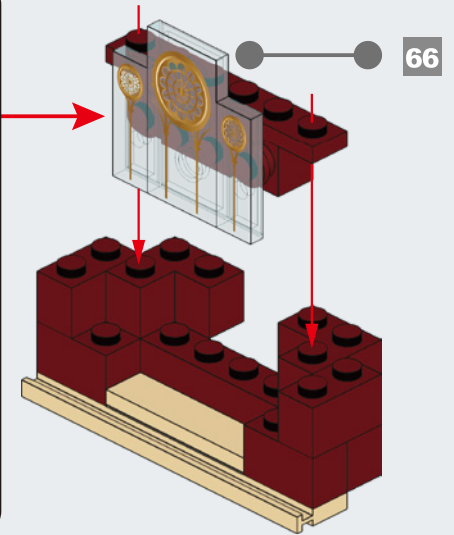
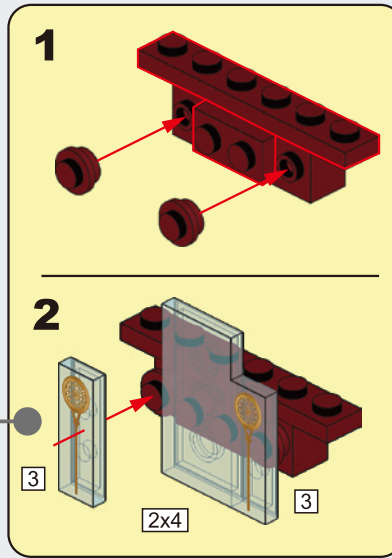

A18

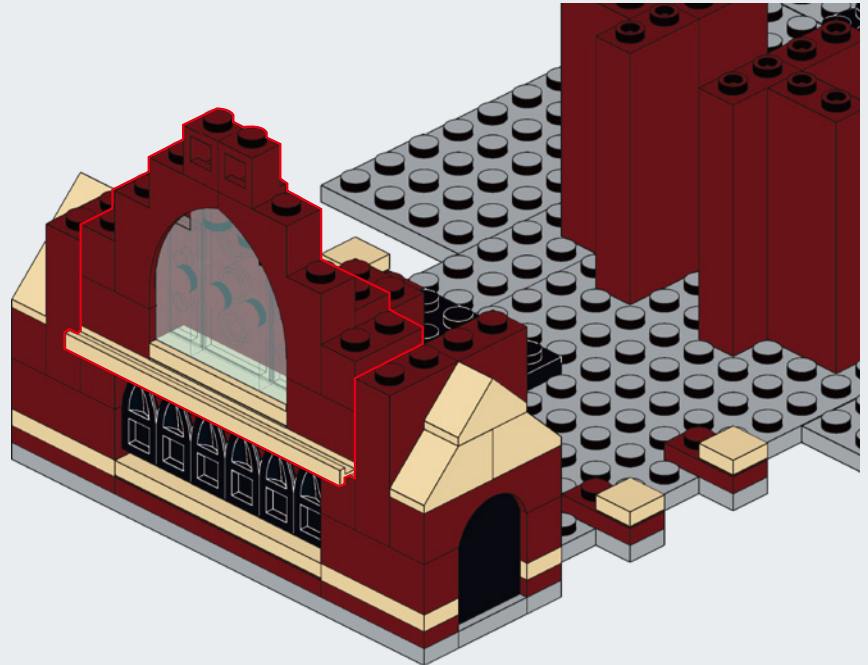
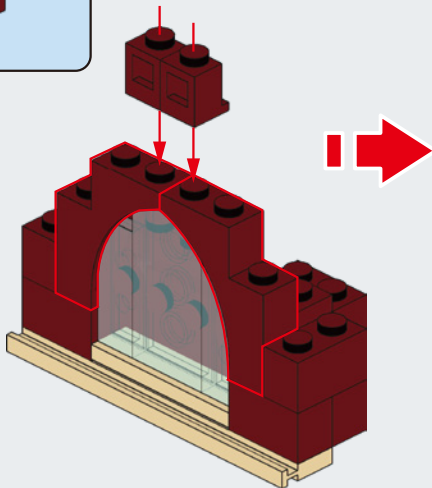

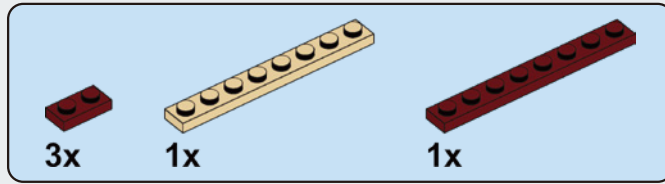
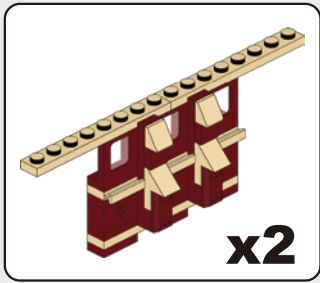

A19

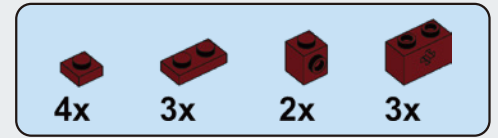
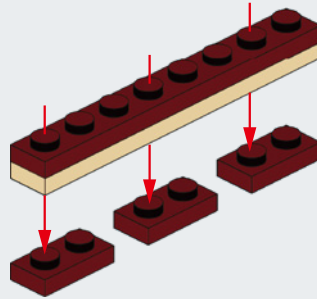

A20

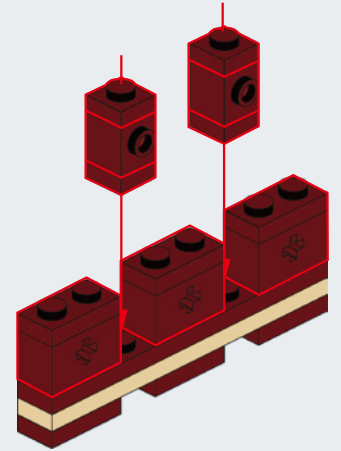

A21

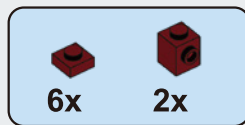
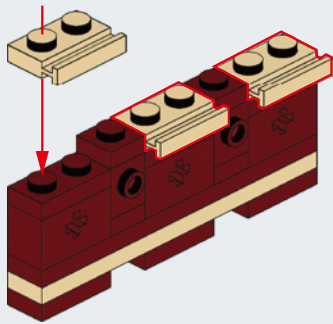

A22

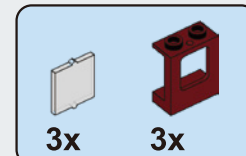
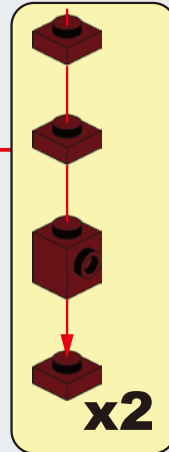
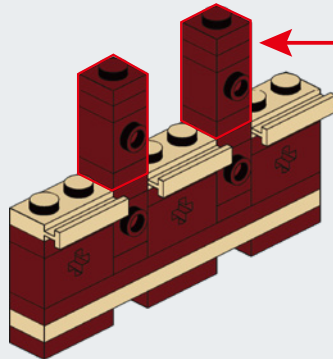

A23

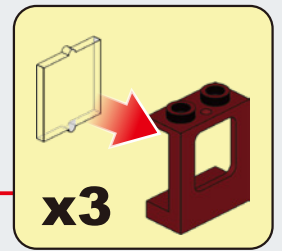
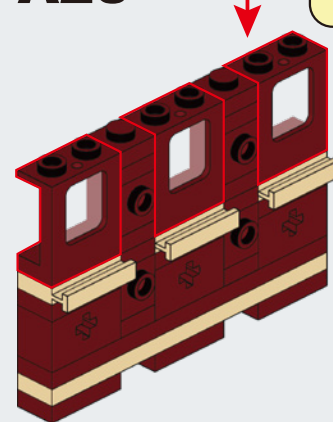

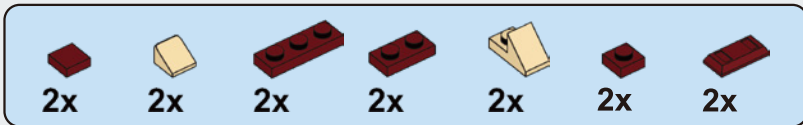

A24

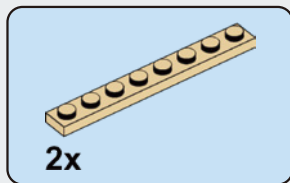
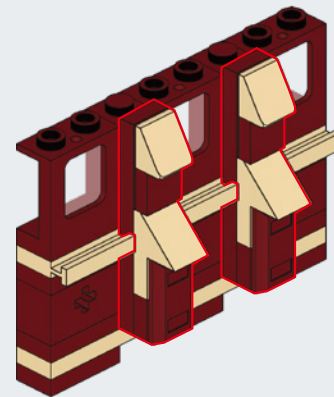
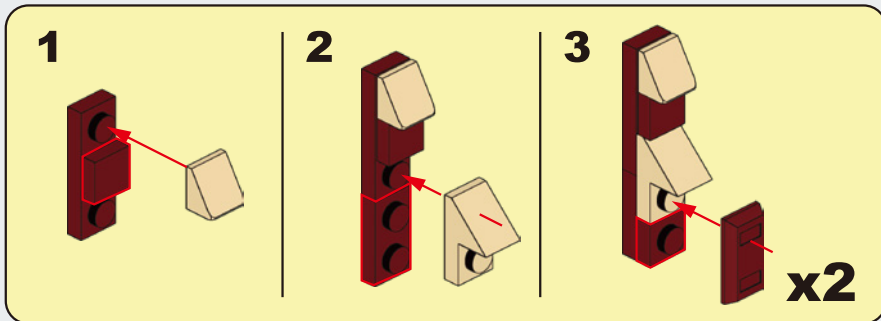

A25

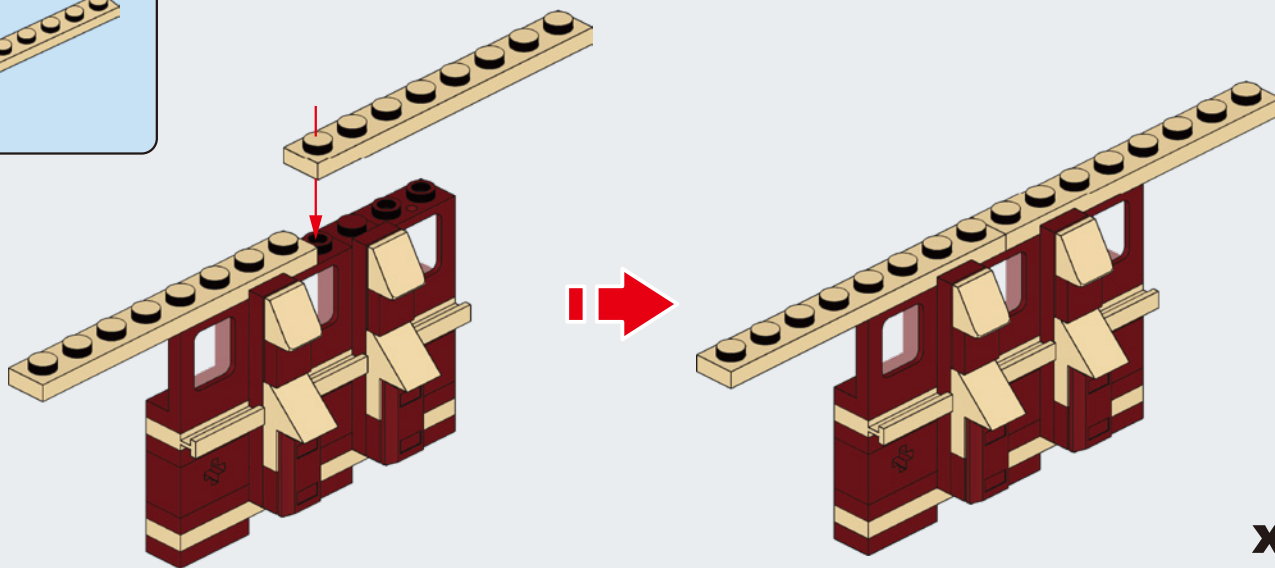

A26

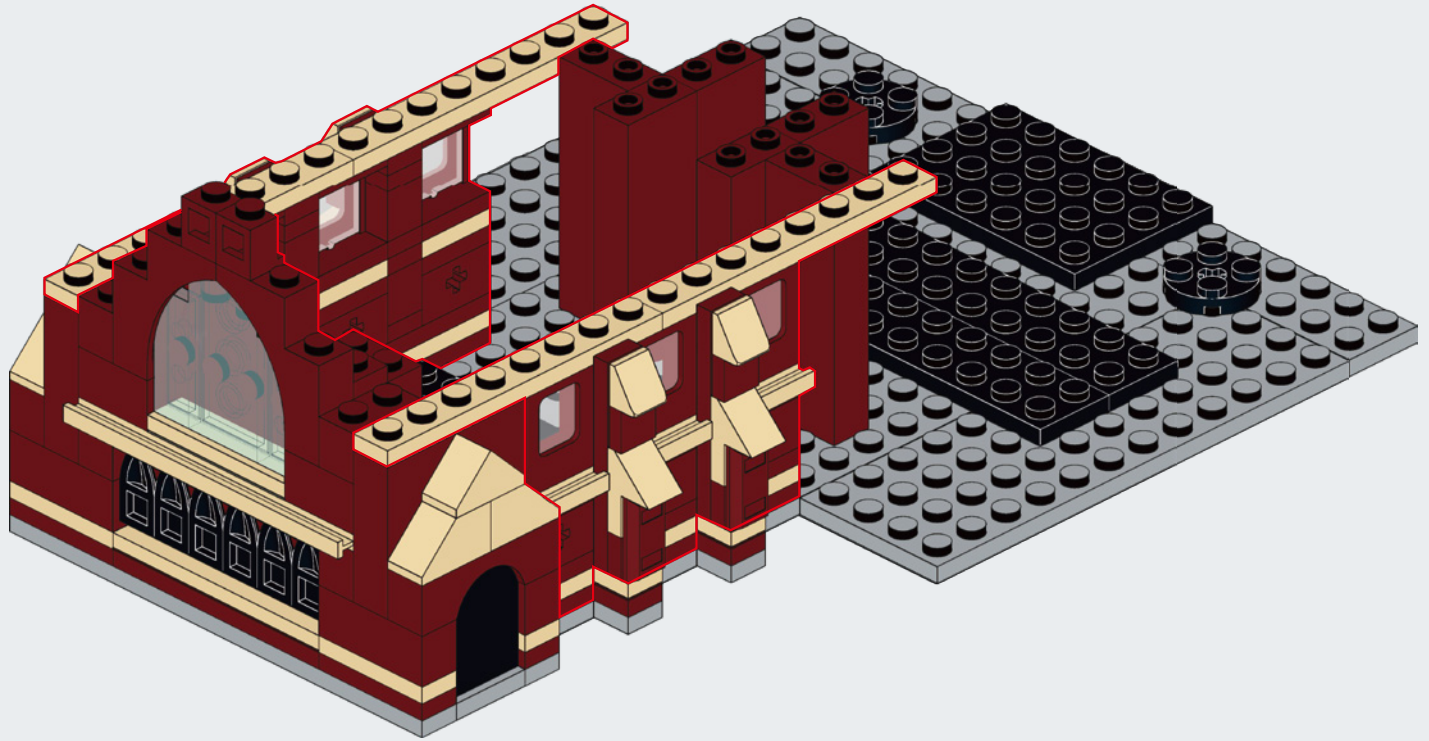

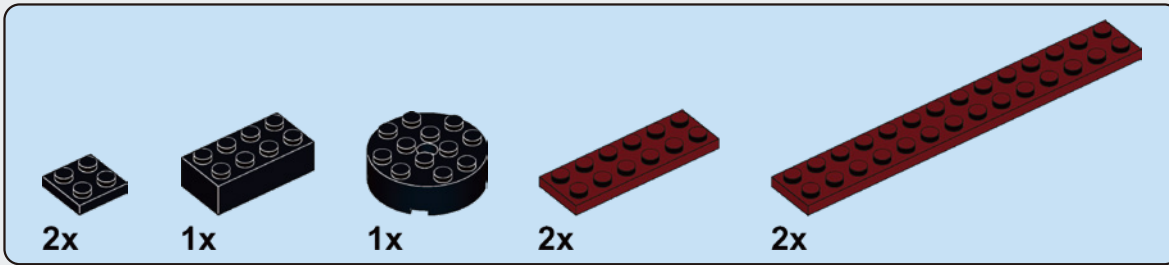

A27

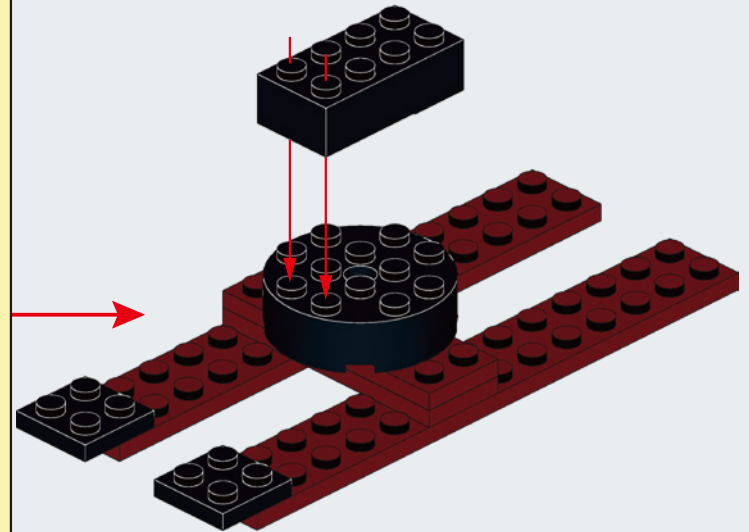
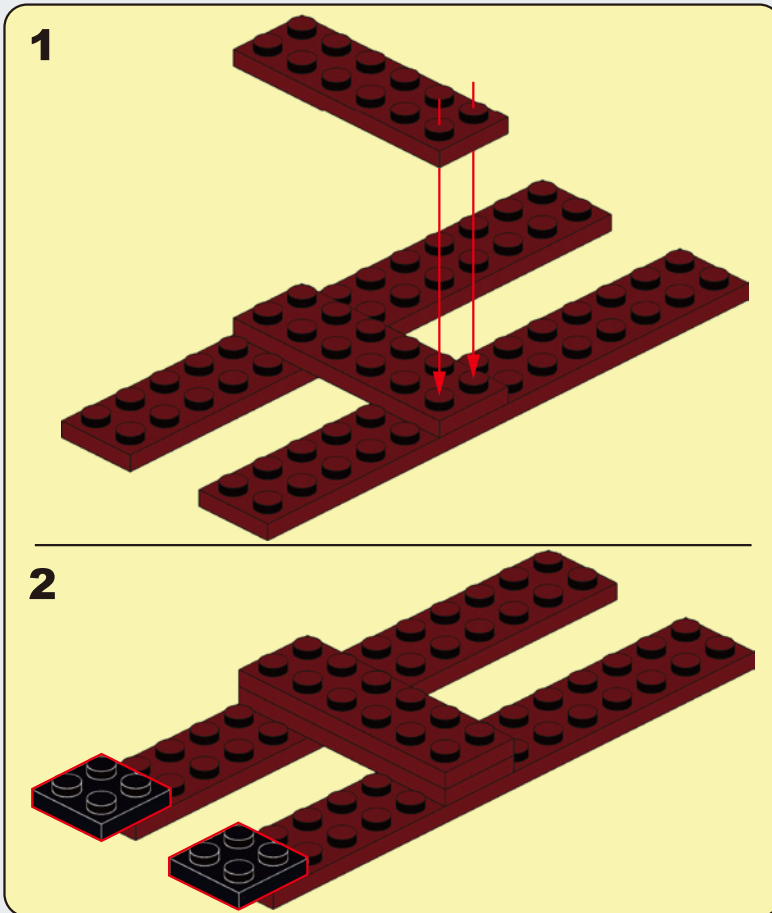

A28

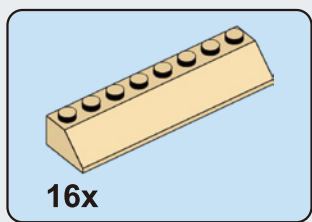
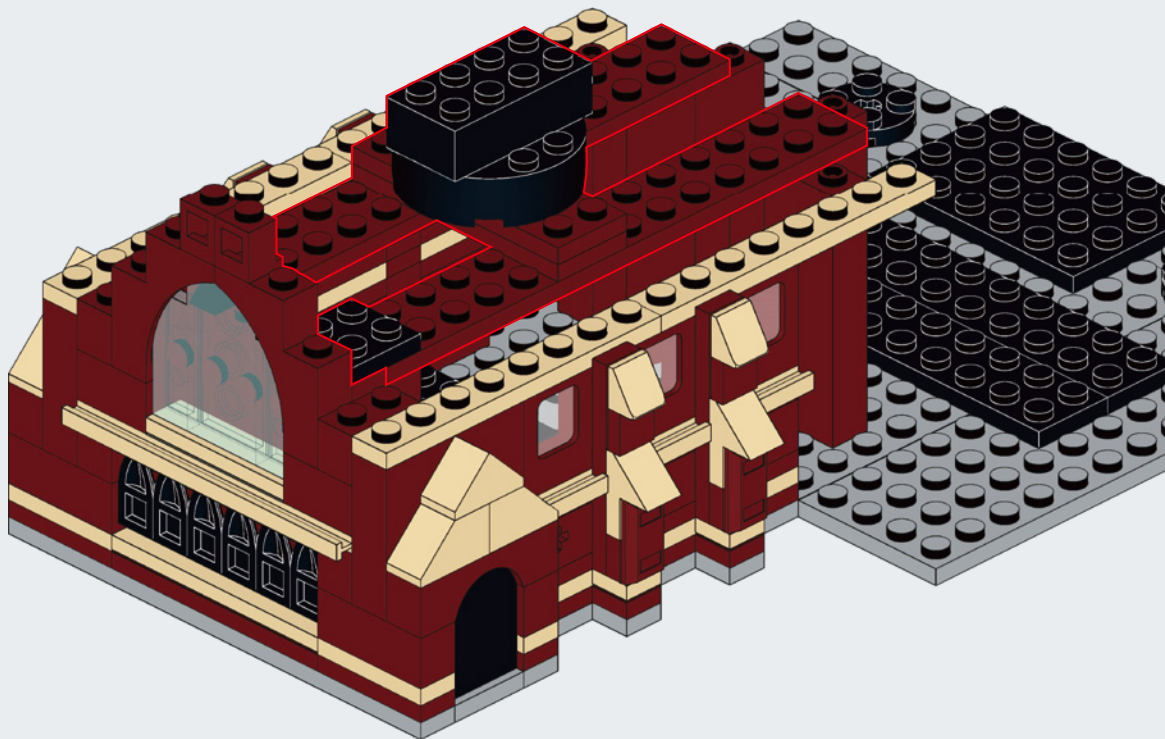

A29

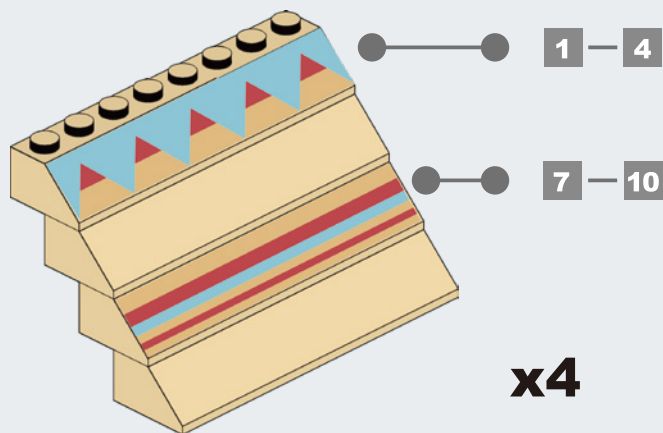

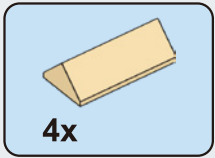

A30

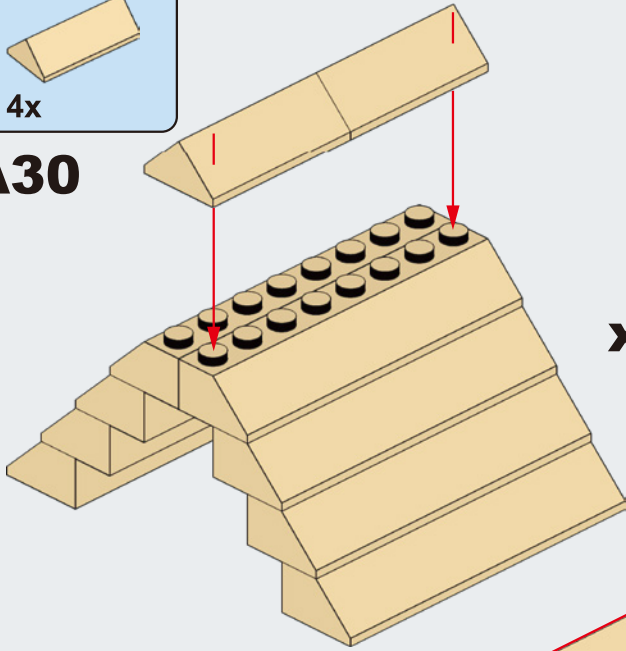

x2

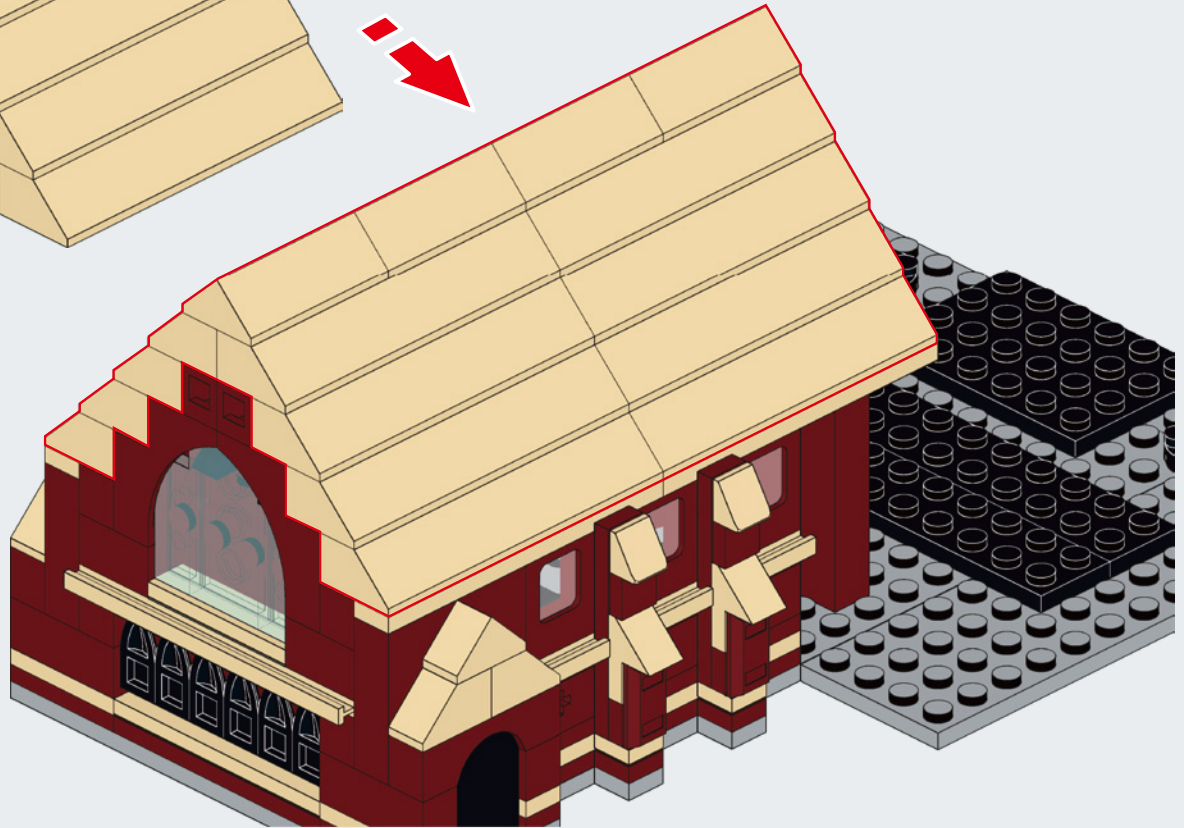

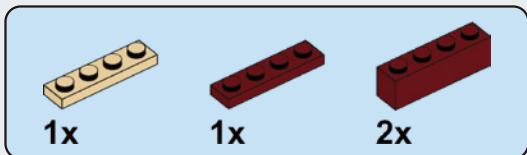

A31

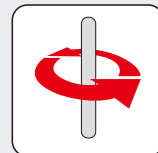
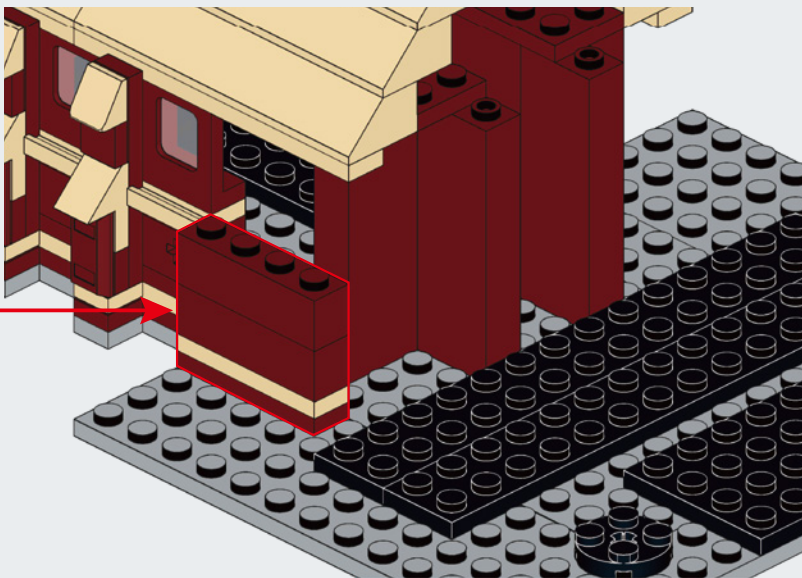
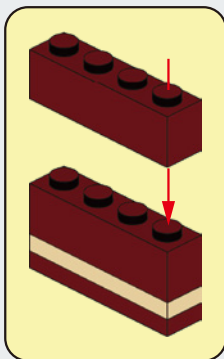

A32

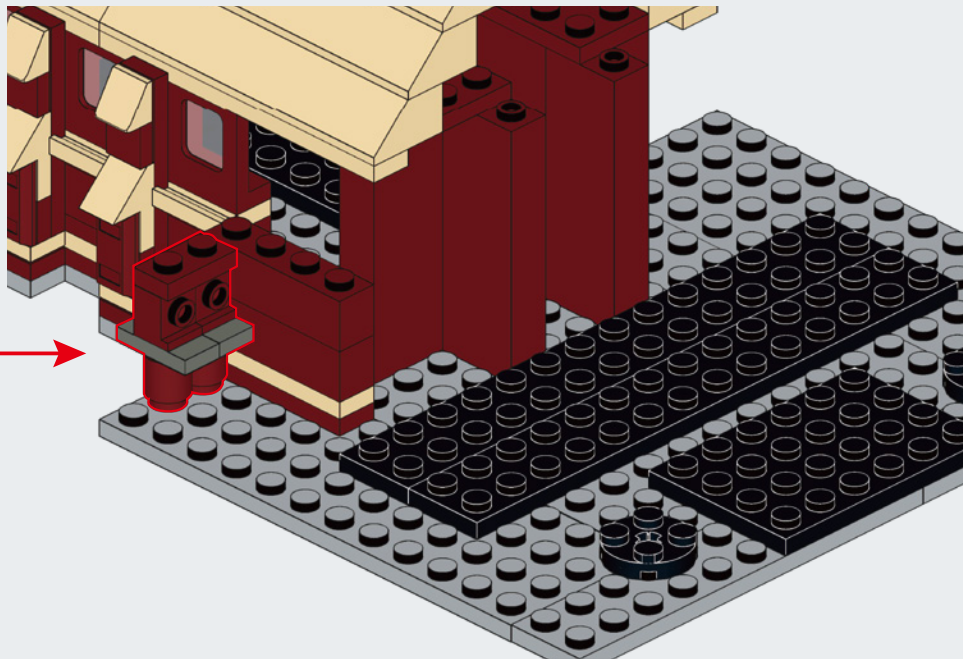
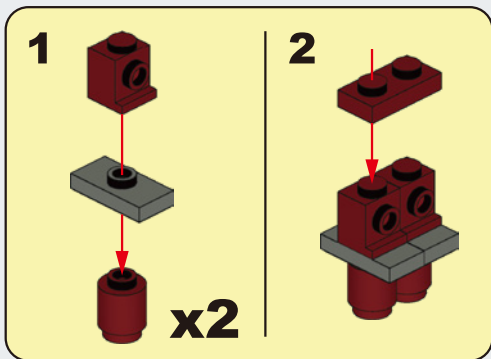

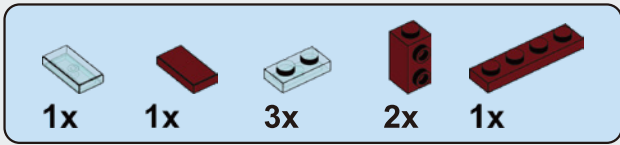

A33

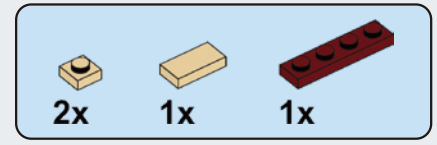
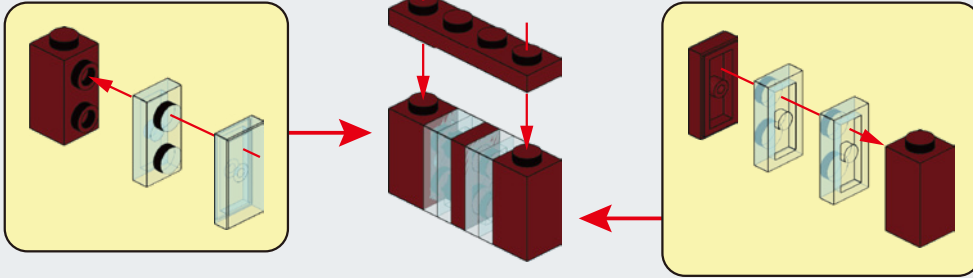

A34

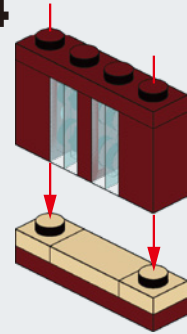

A35

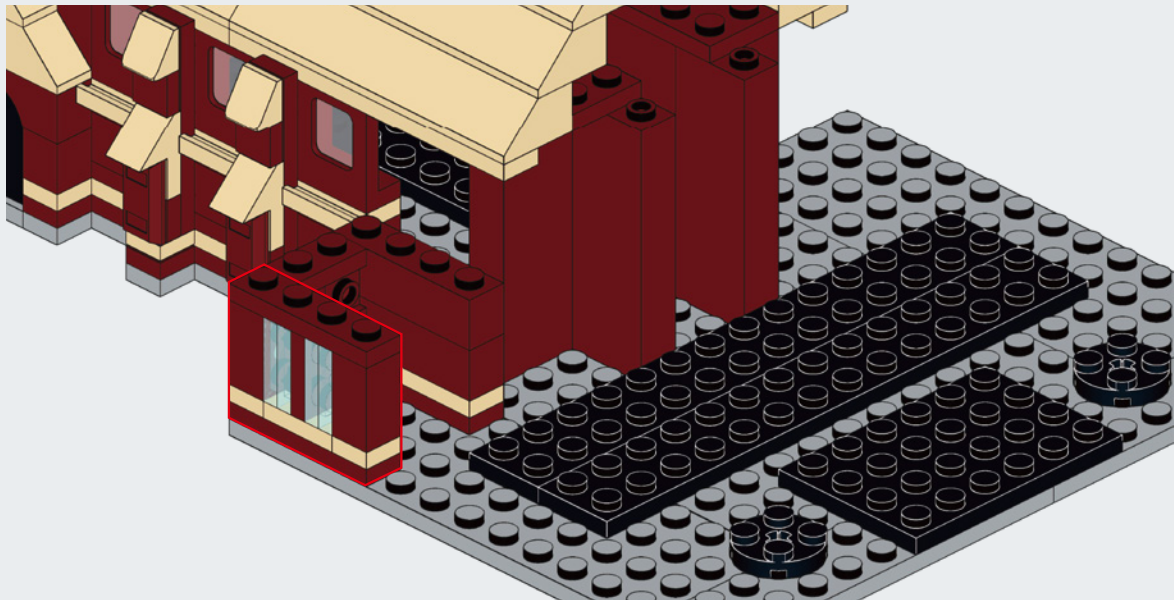

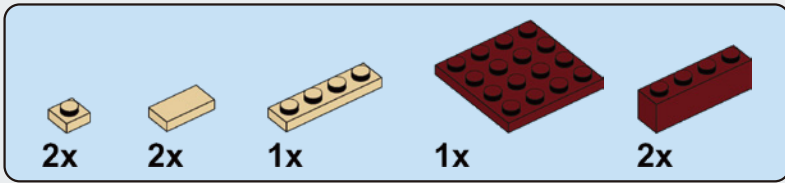

A36

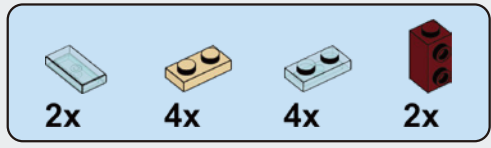
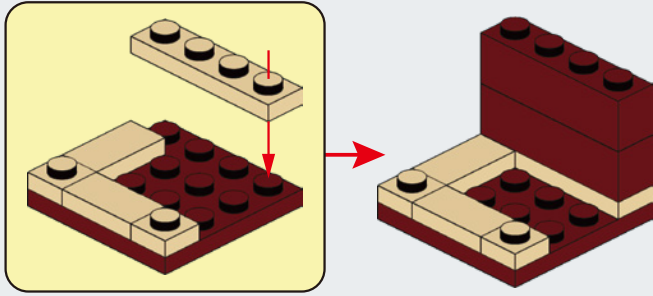

A37

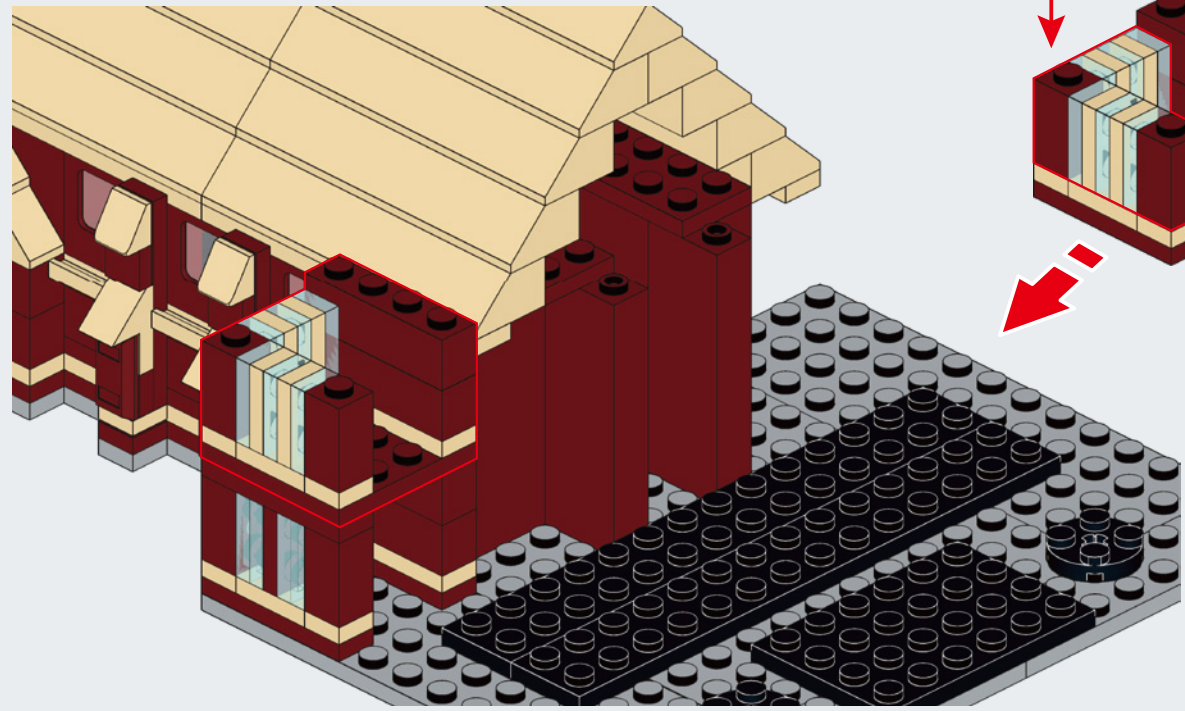
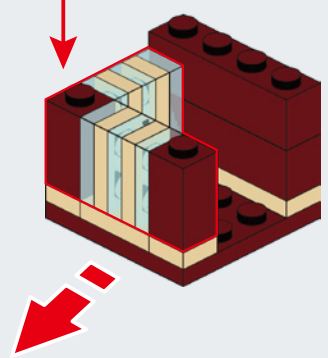
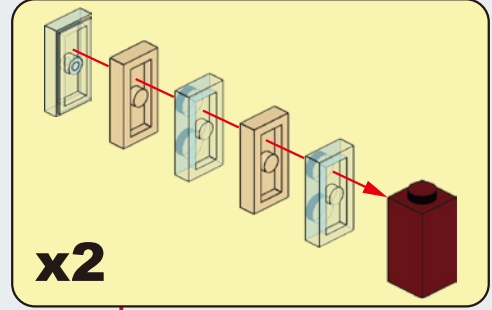

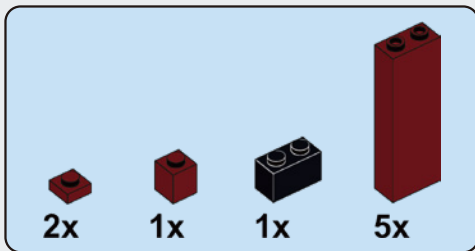

A38

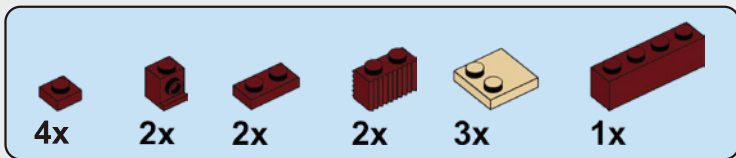
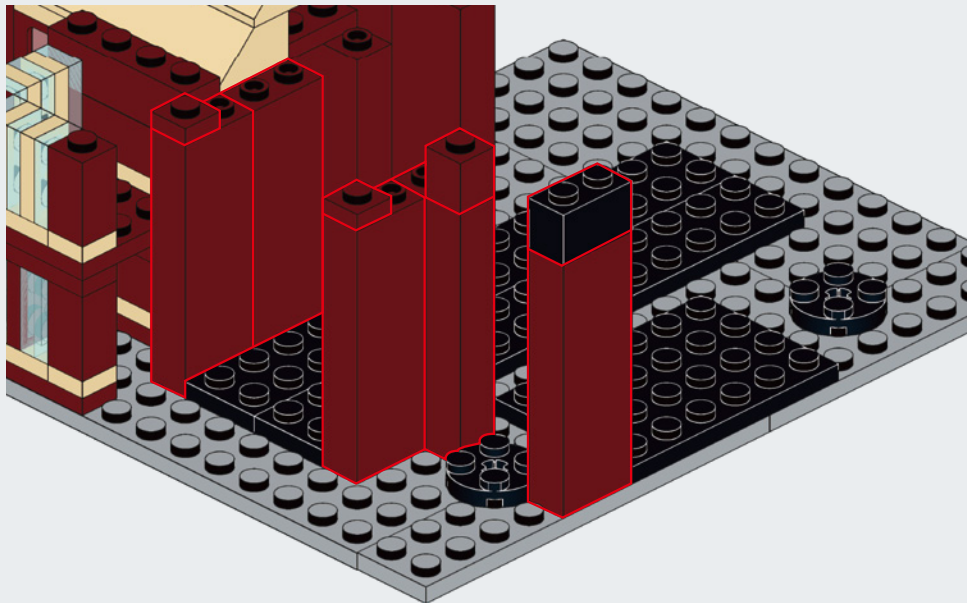

A39

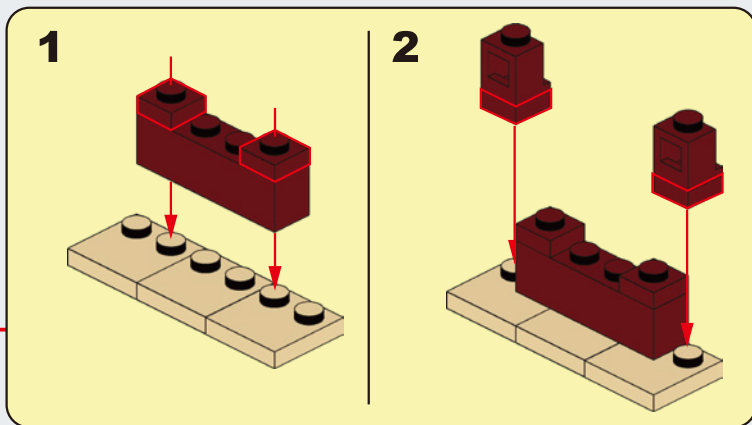
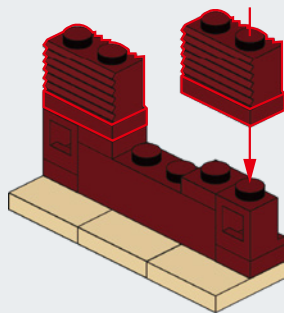

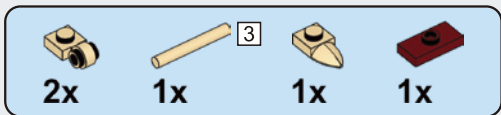

A40

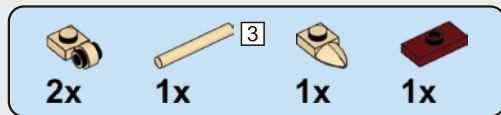
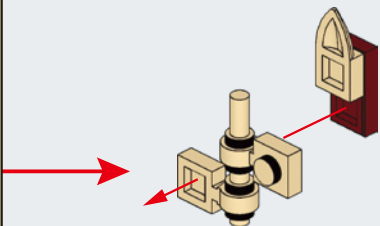
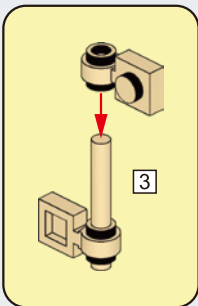
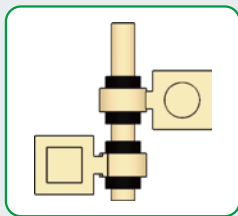

A41

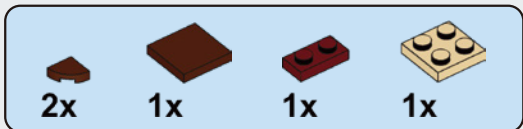
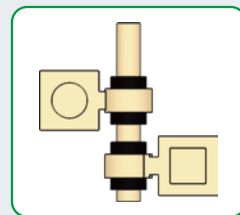
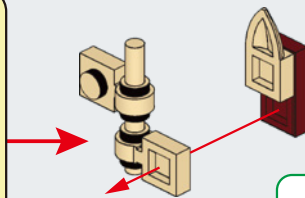
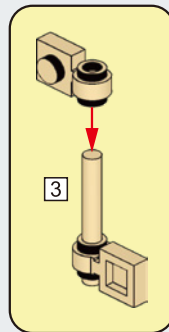

A42

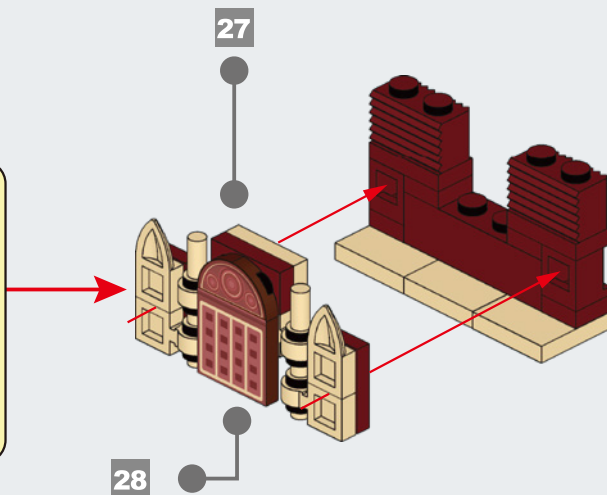
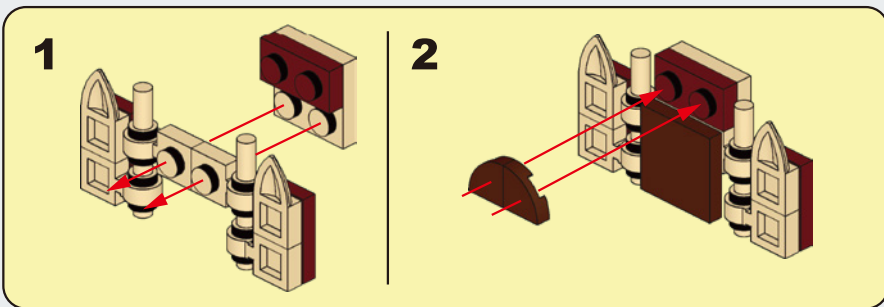

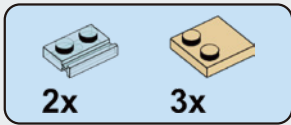

A43

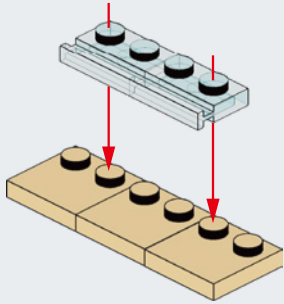

A44

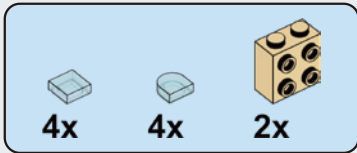
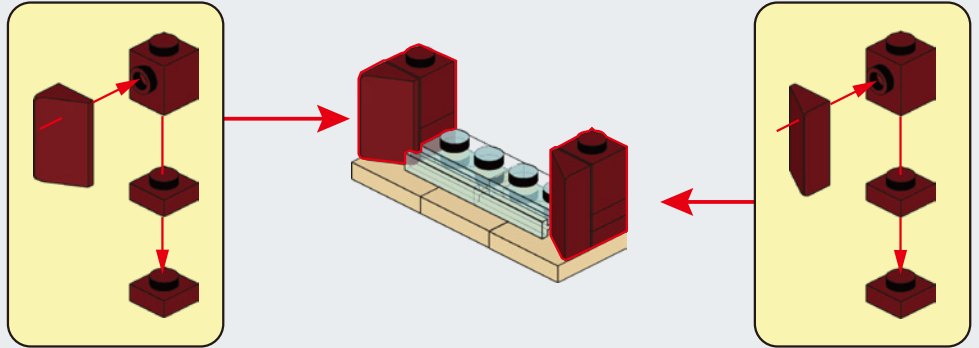

A45

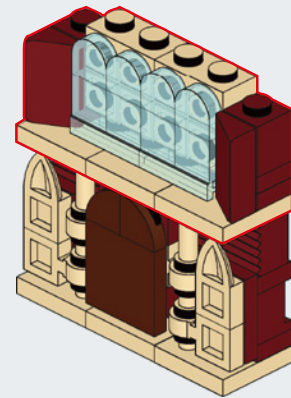
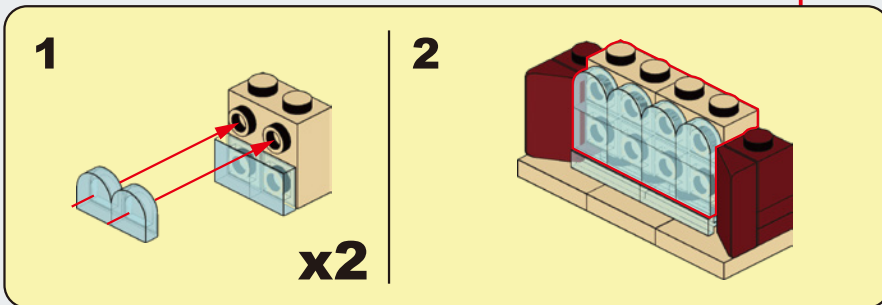

A46

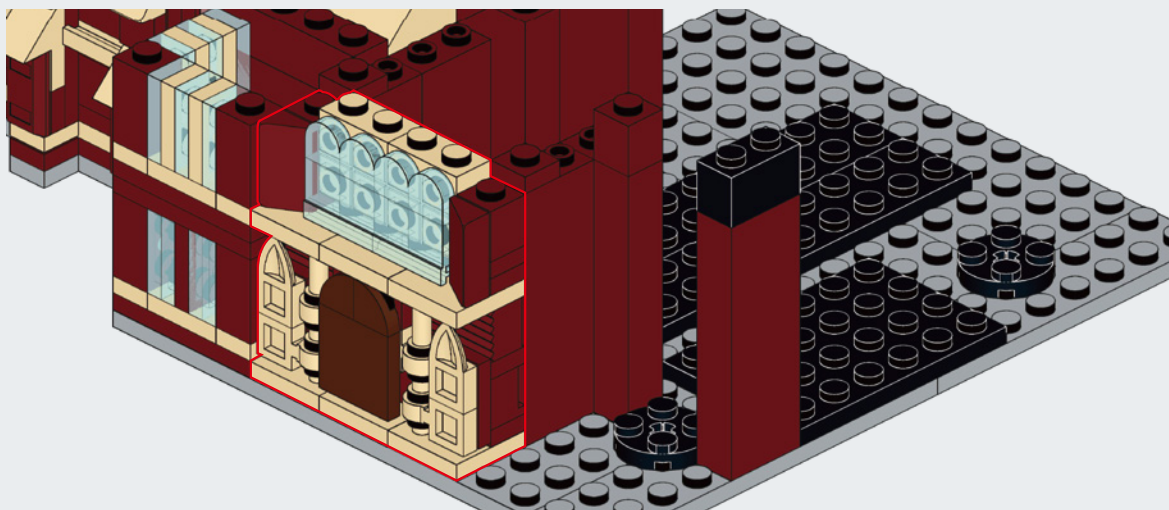

A47

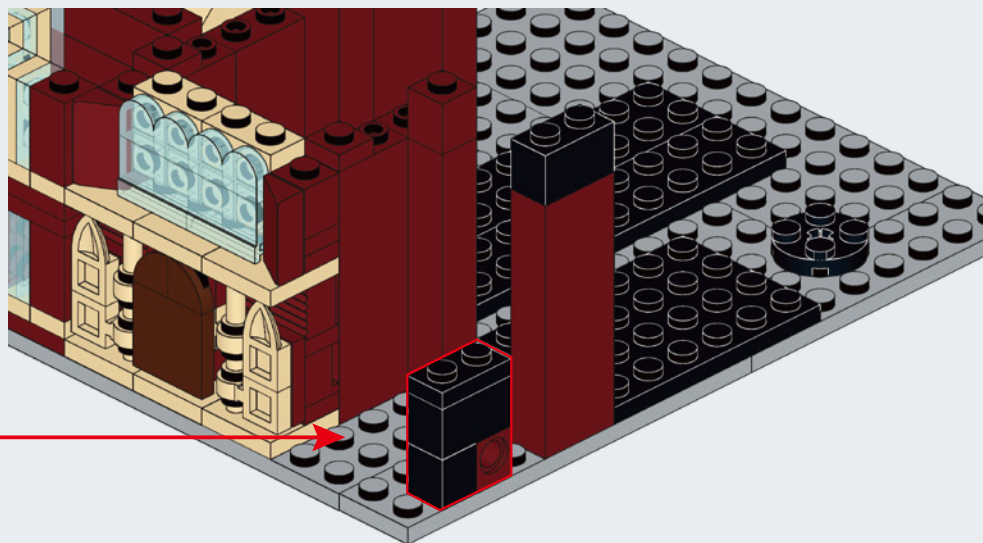
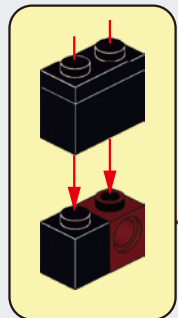

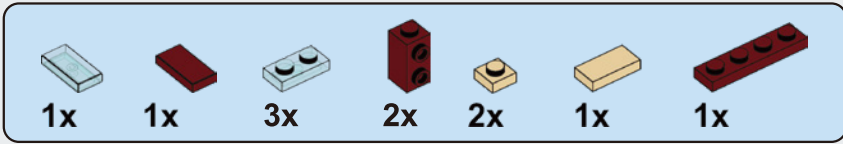

A48

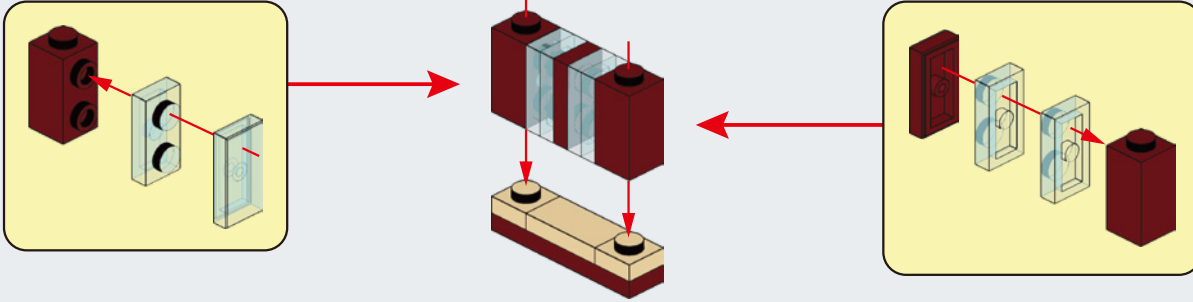

A49

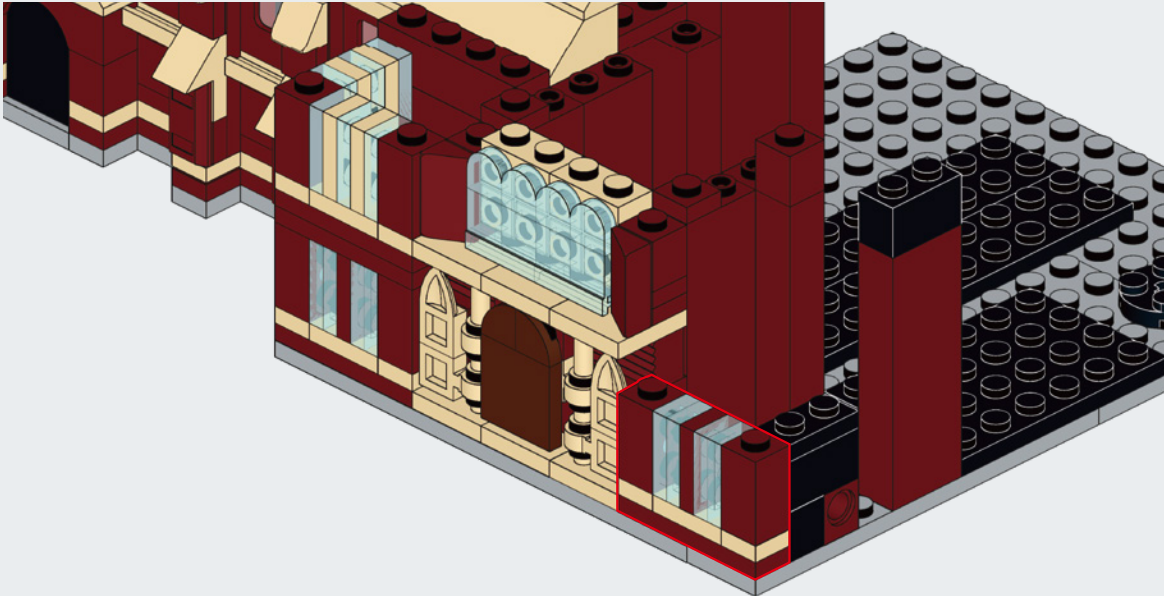

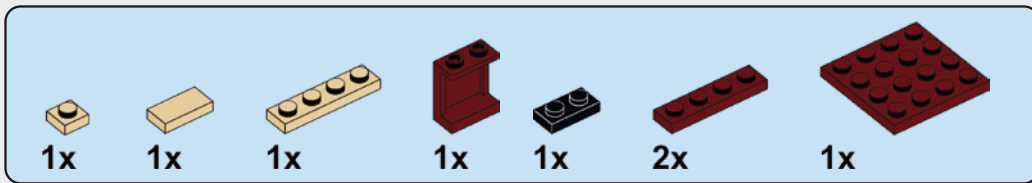

A50

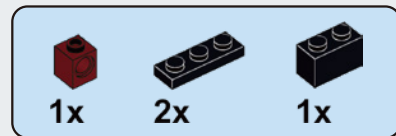
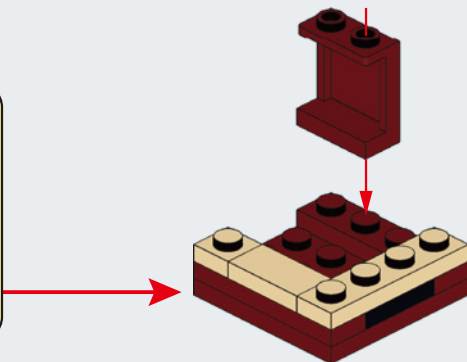
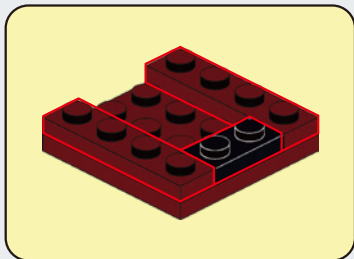

A51

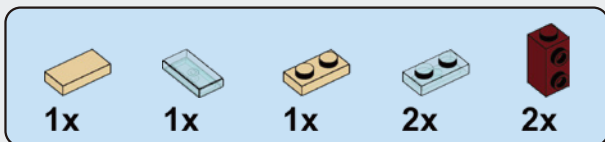
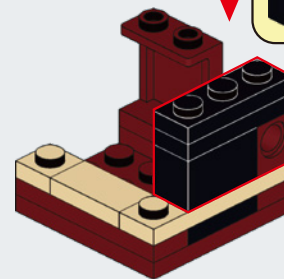
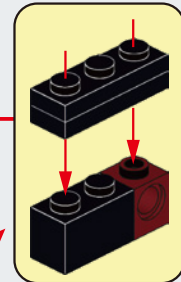

A52

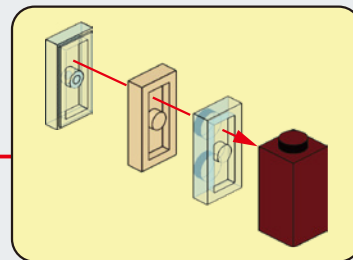
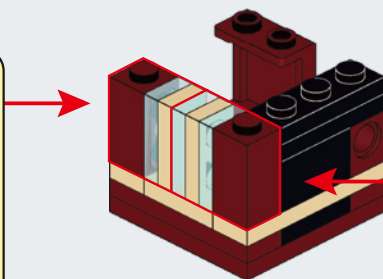
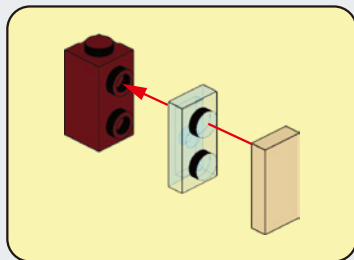

A53

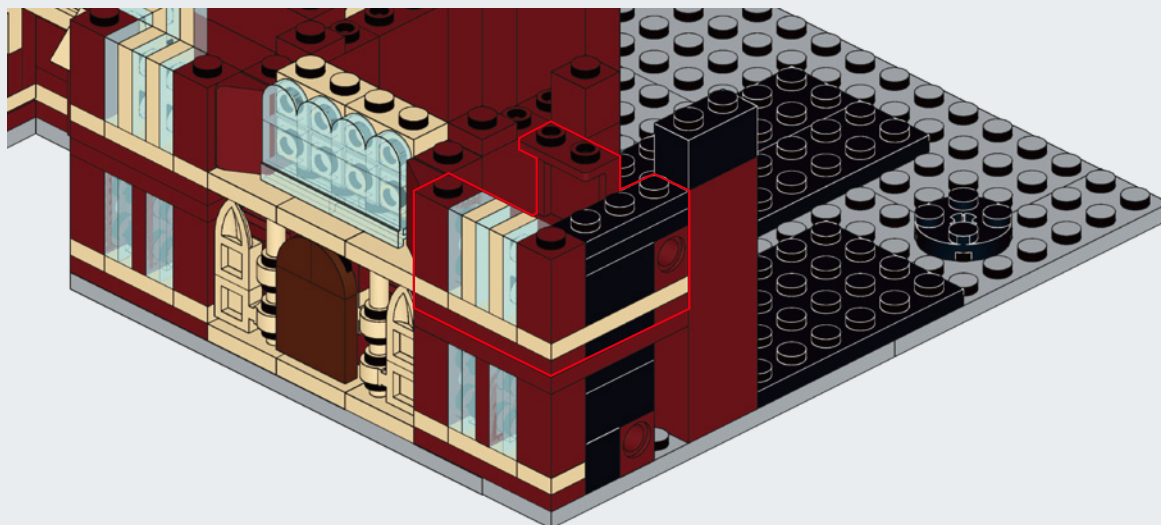

A54

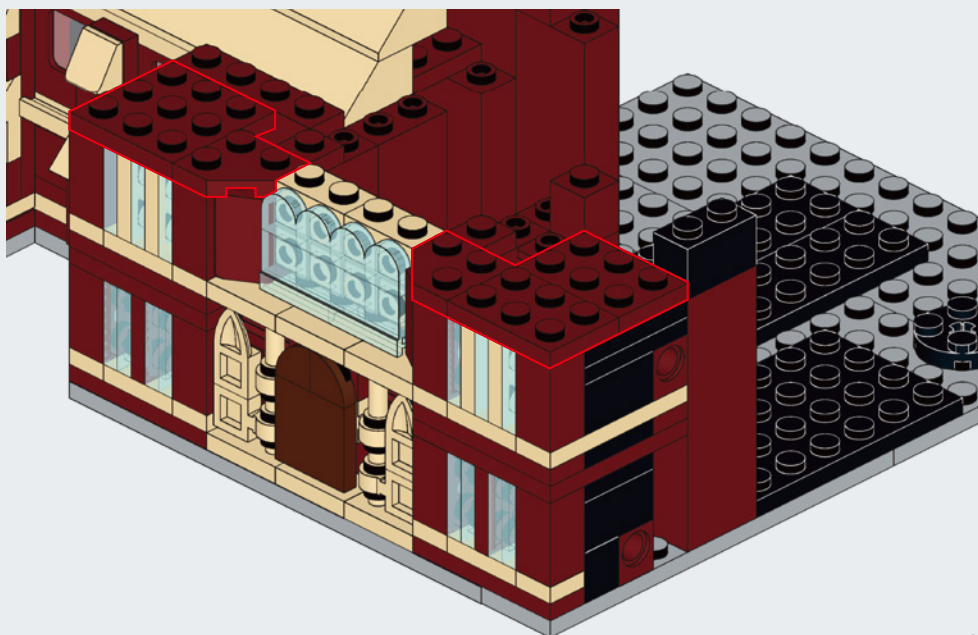

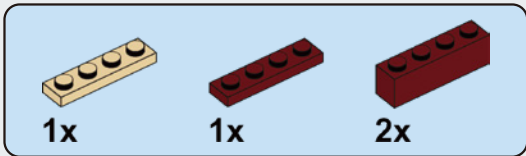

A55

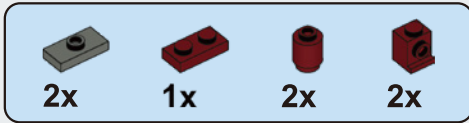
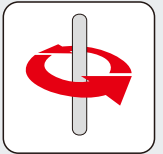
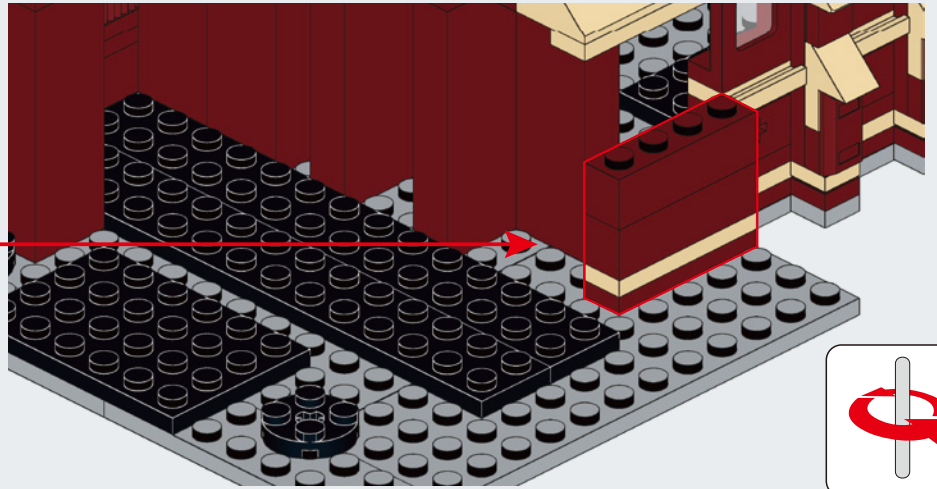
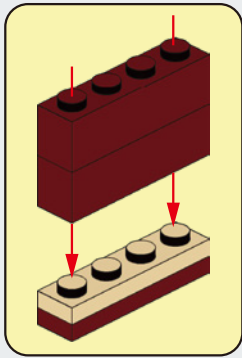

A56

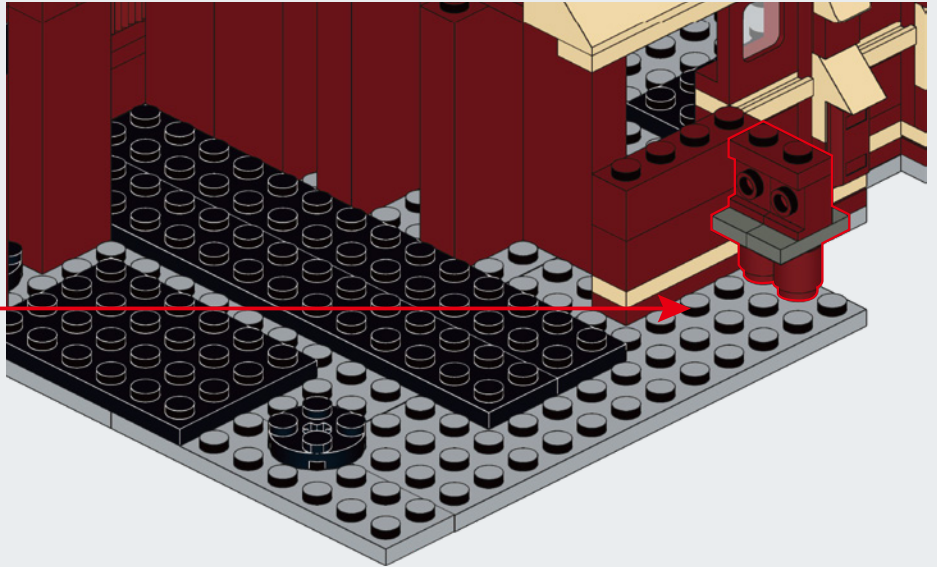
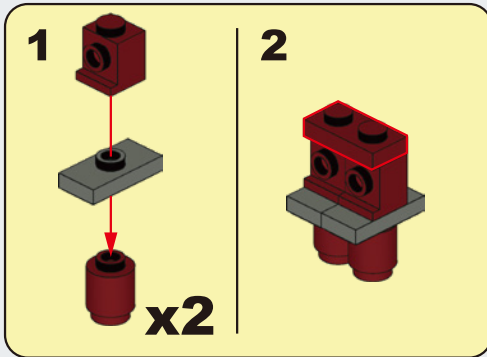

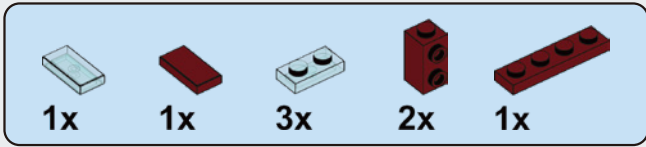

A57

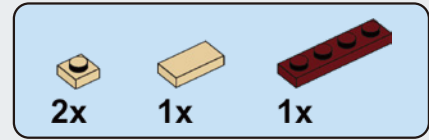
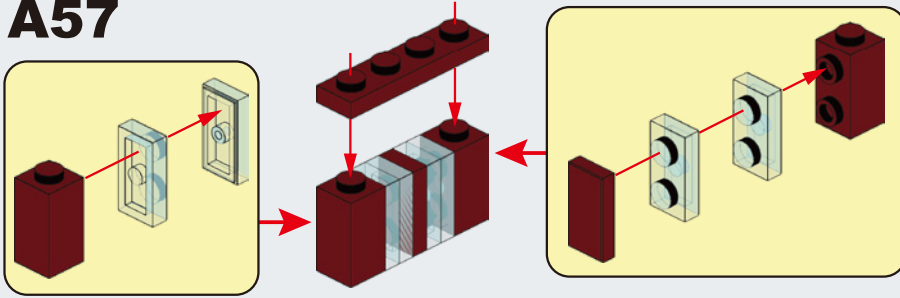

A58

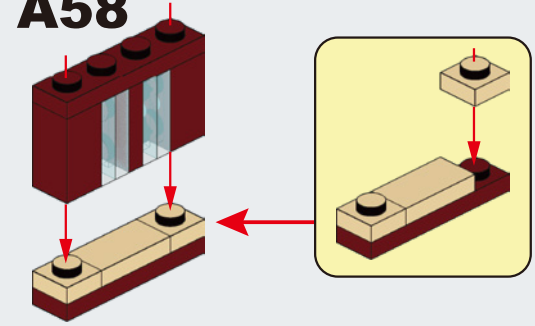

A59

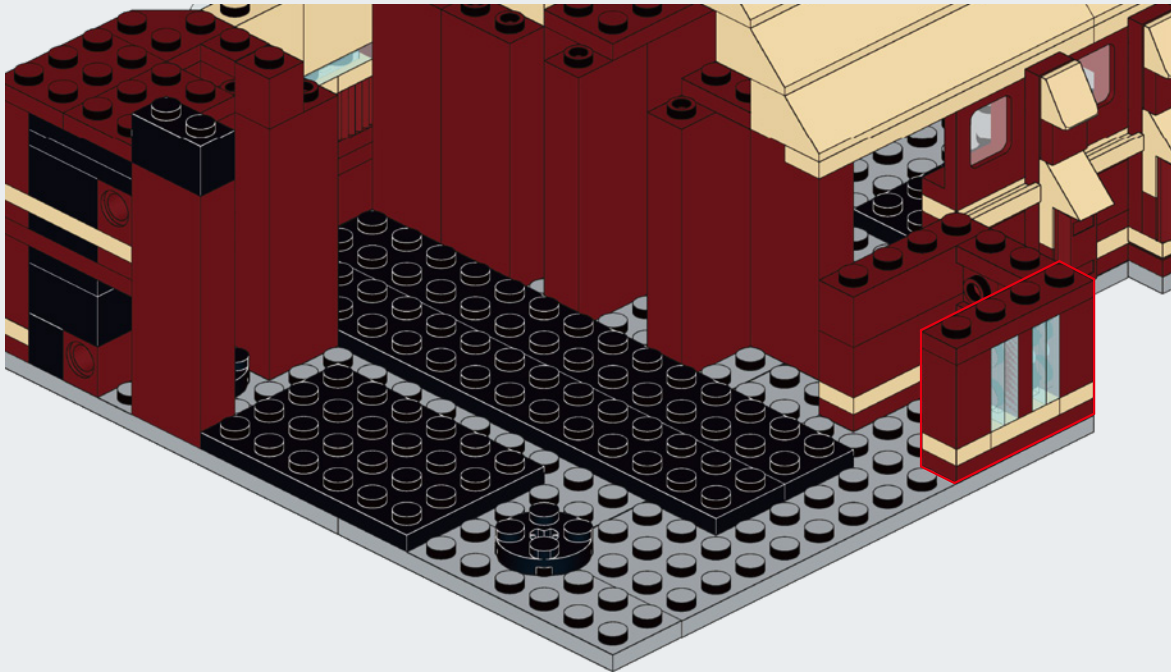

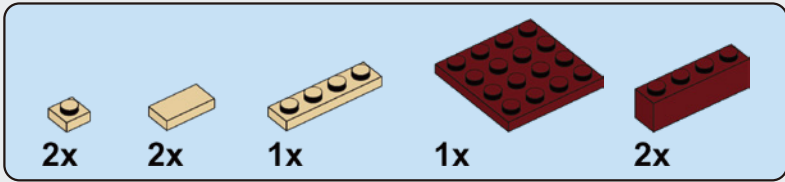

A60

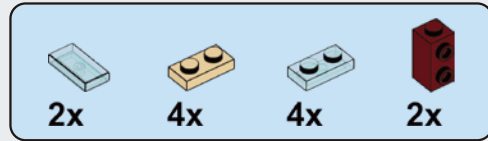
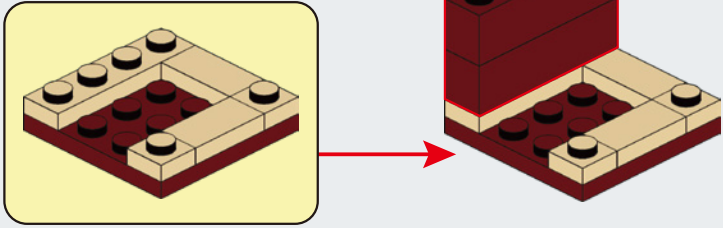

A61

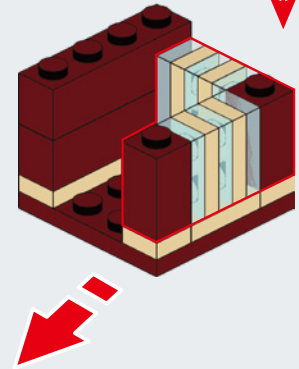
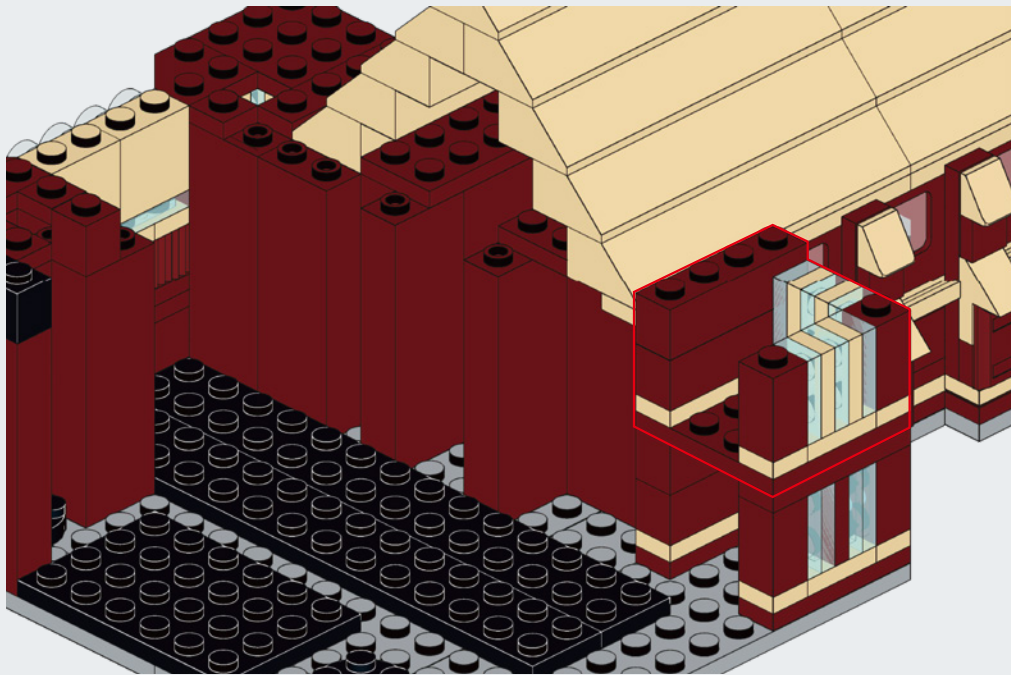
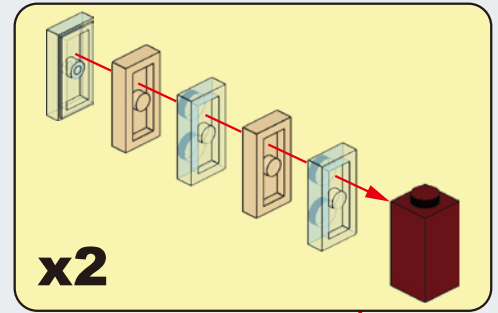

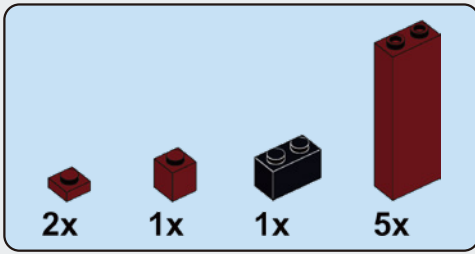

A62

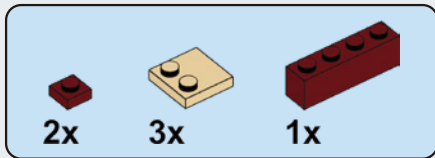
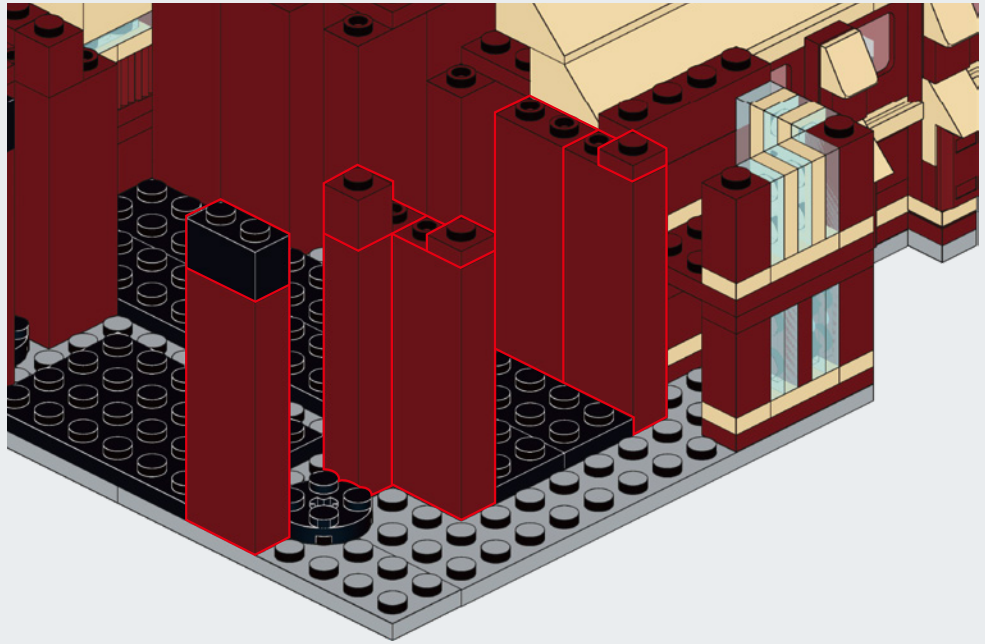

A63

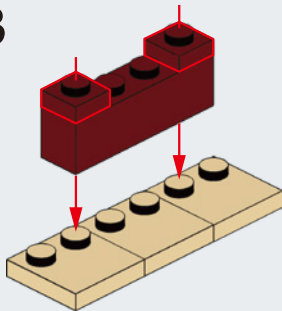

A64

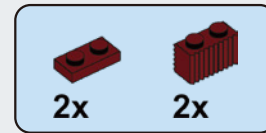
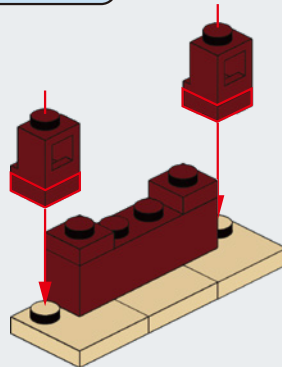

A65

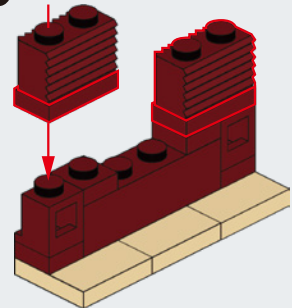

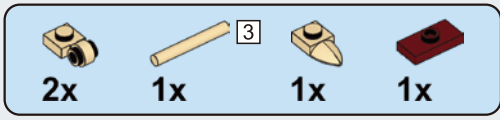

A66

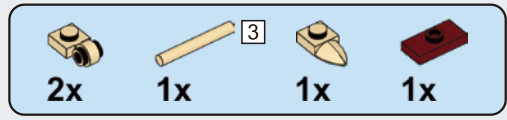
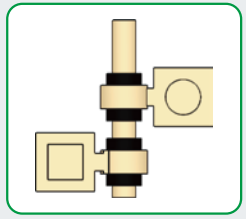
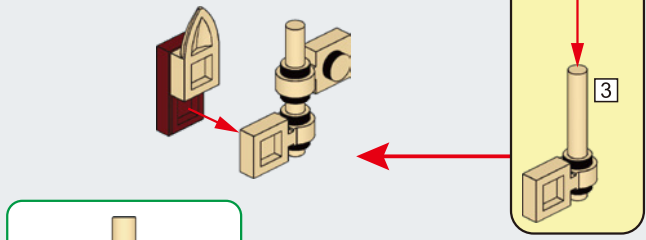

A67

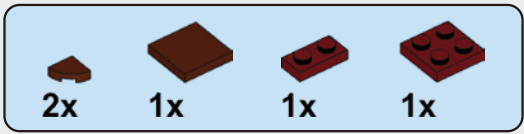
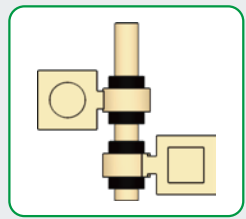
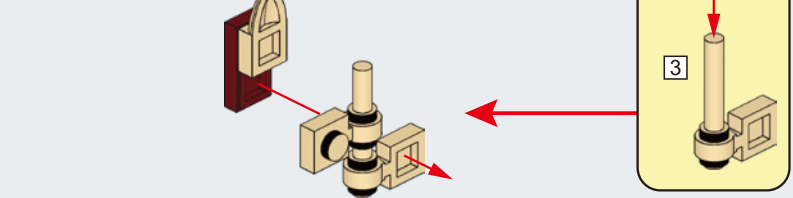

A68

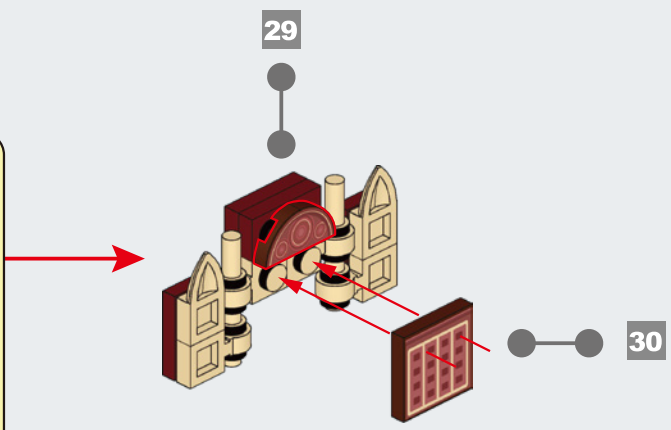
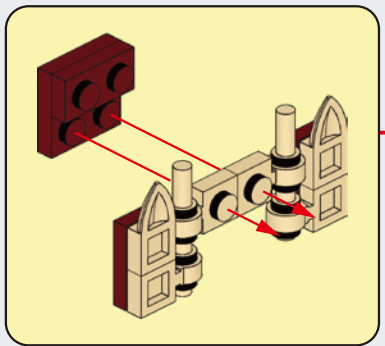

A69

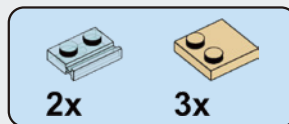
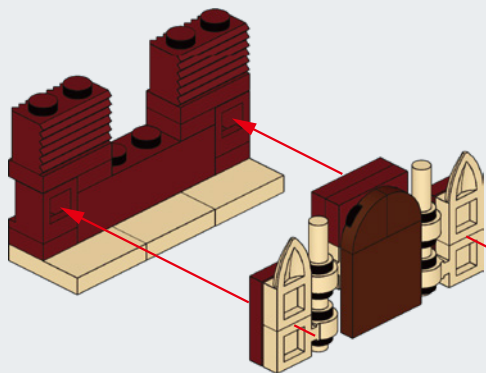

A70

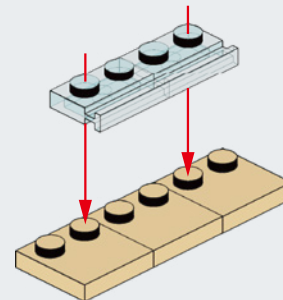

A71

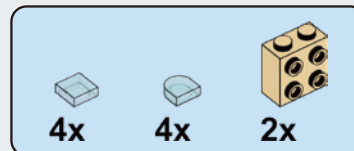
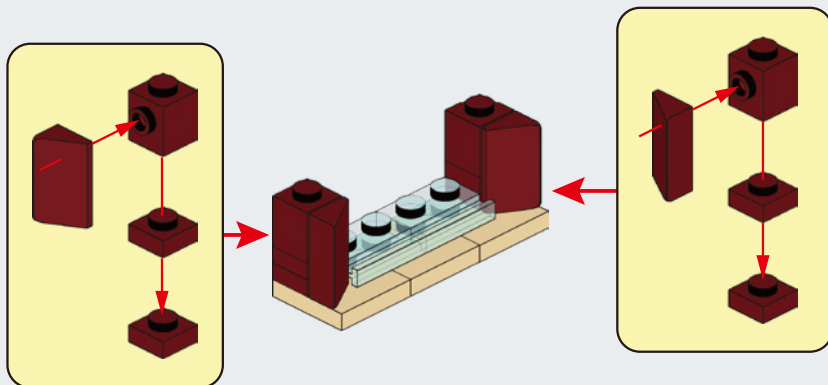

A72

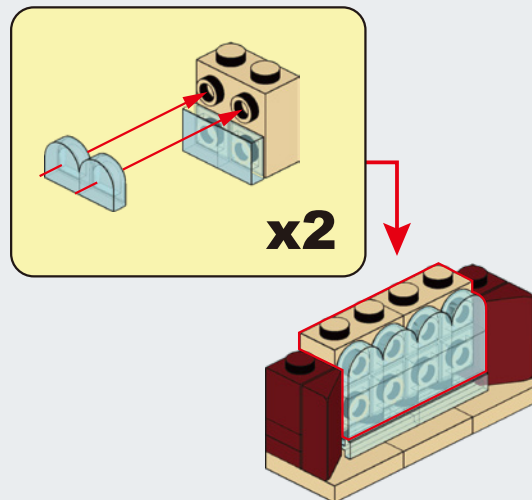

A73

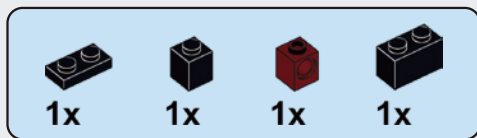
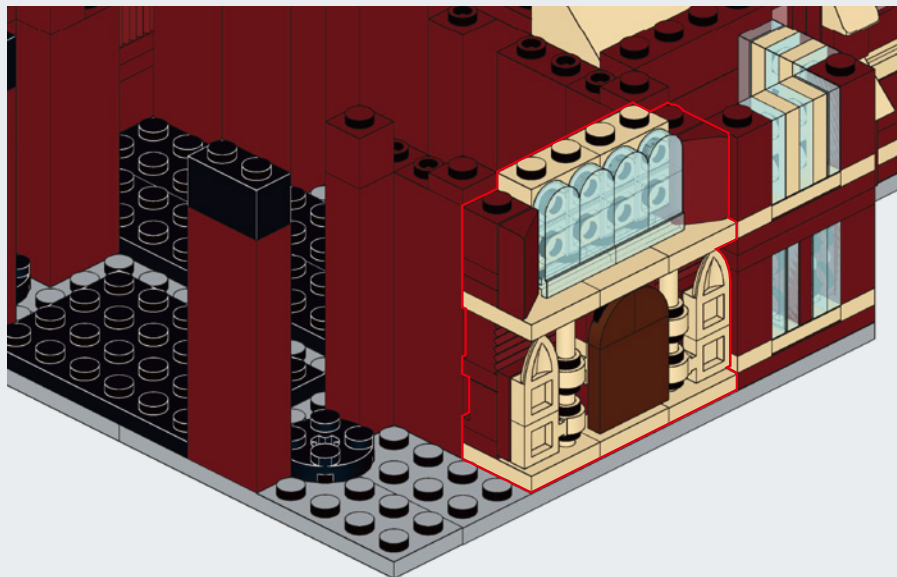
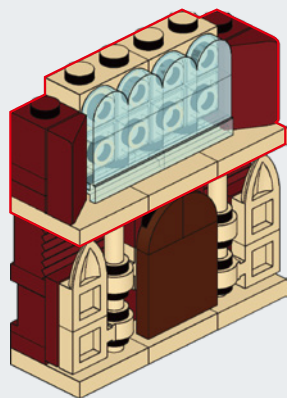

A74

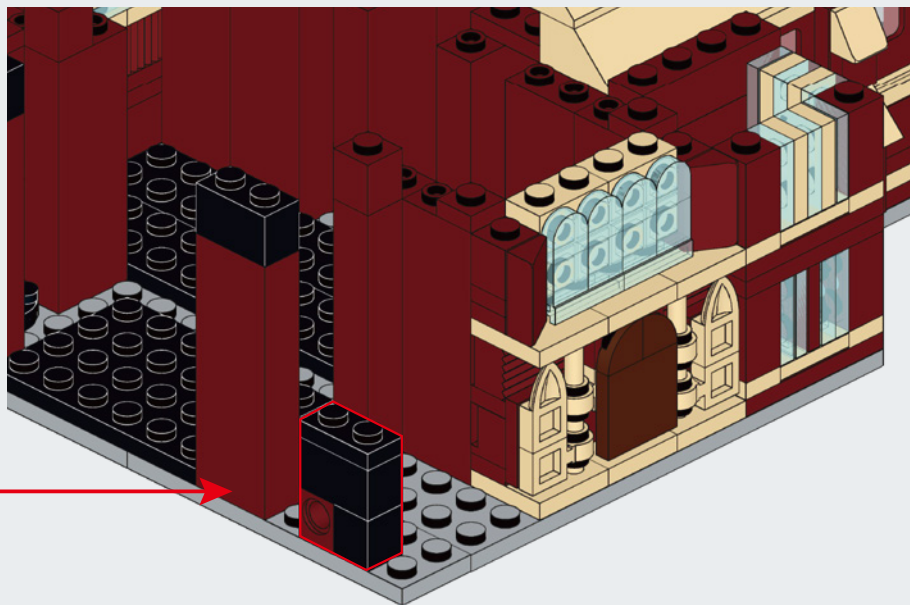
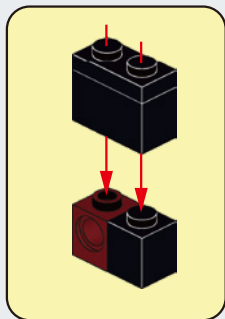

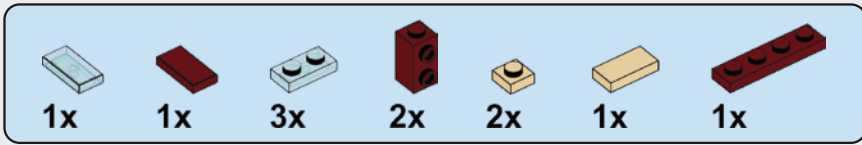

A75

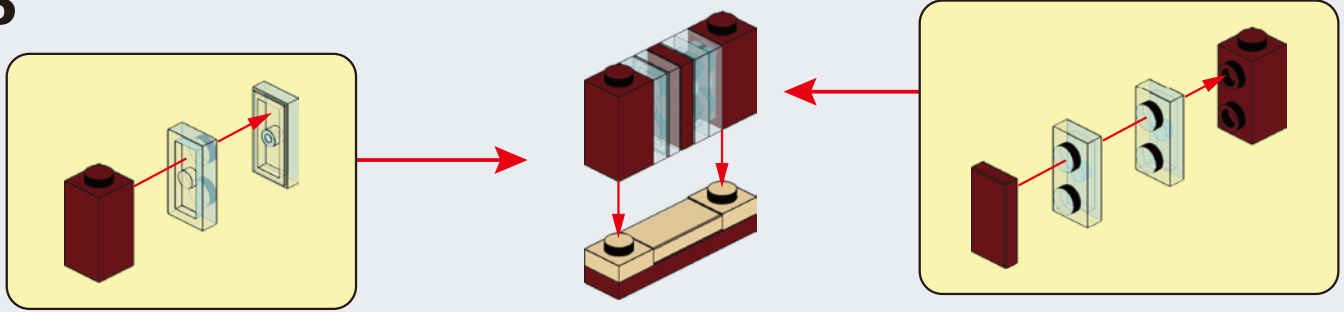

A76

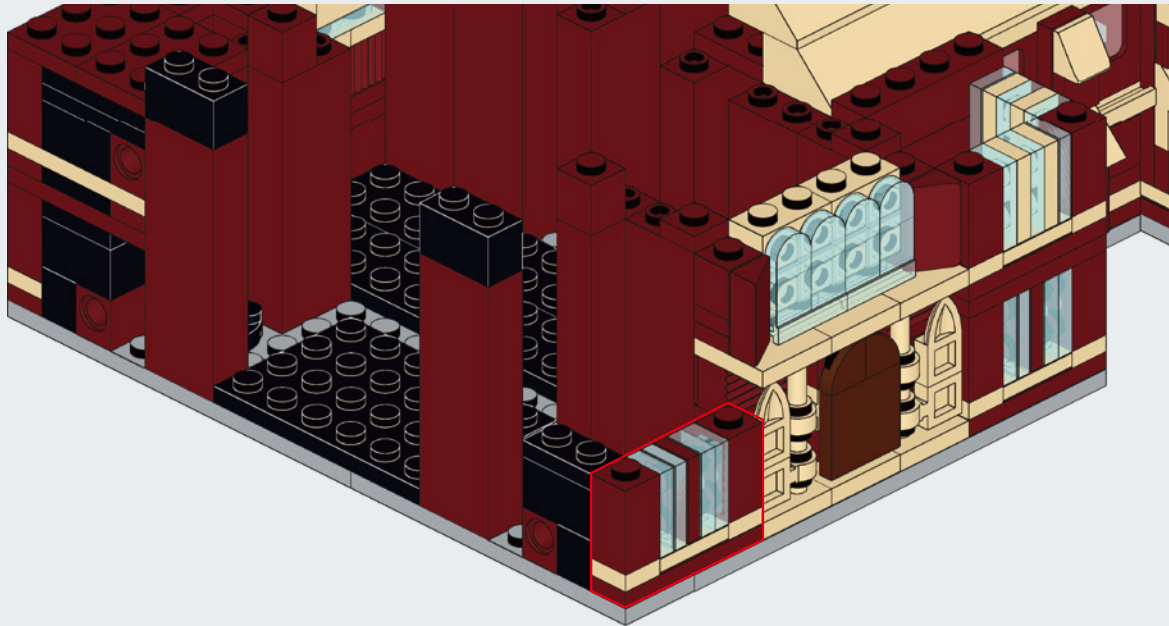

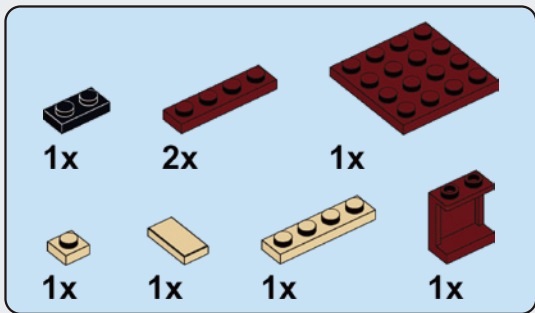

A77

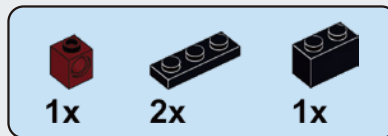
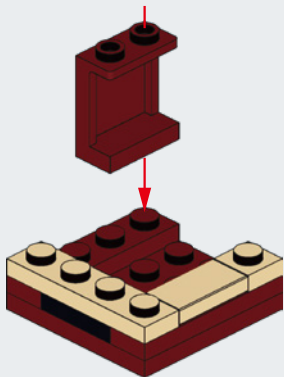

A78

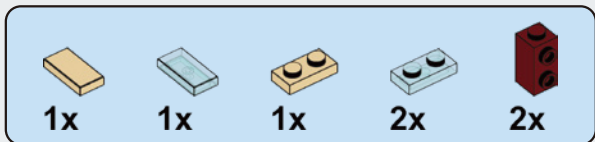
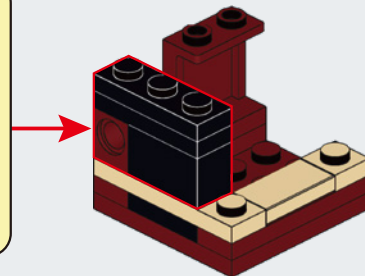
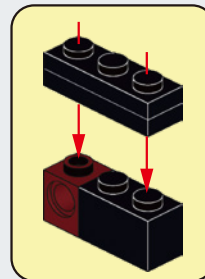

A79

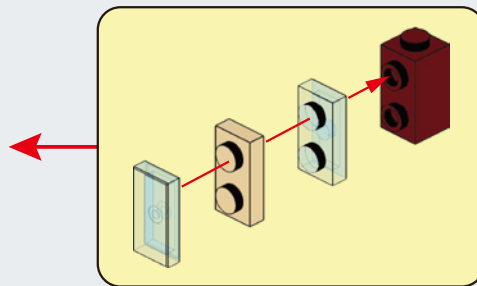
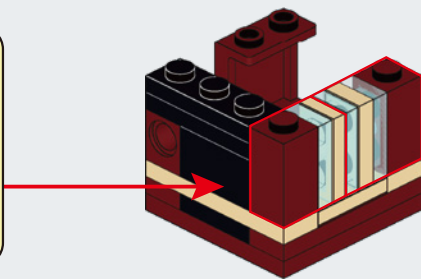
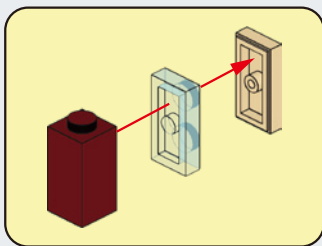

A80

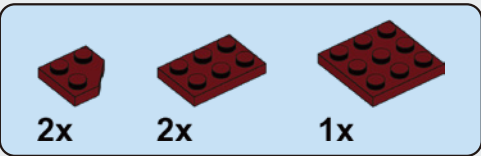
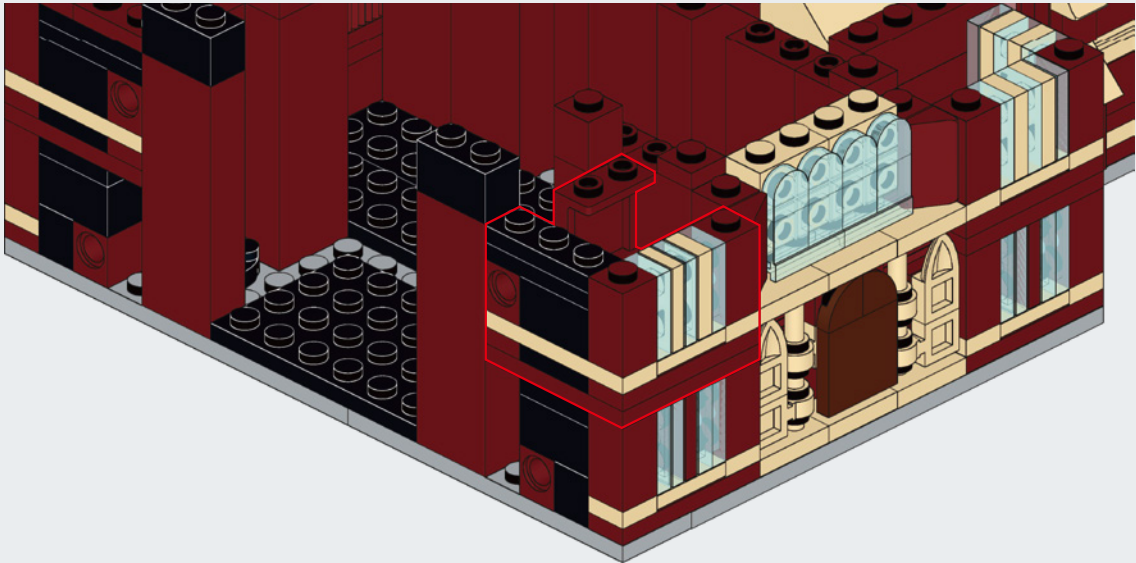

A81

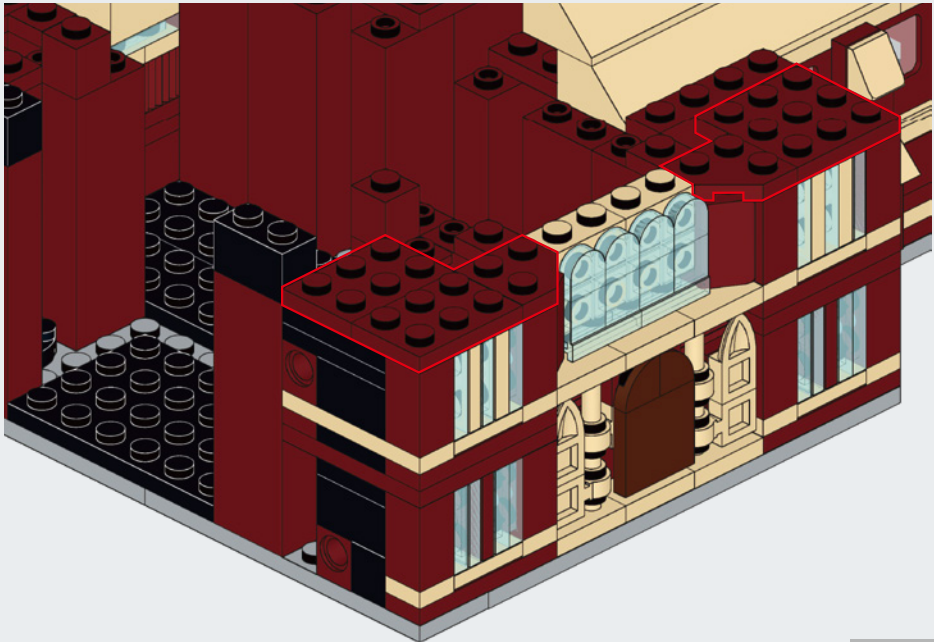

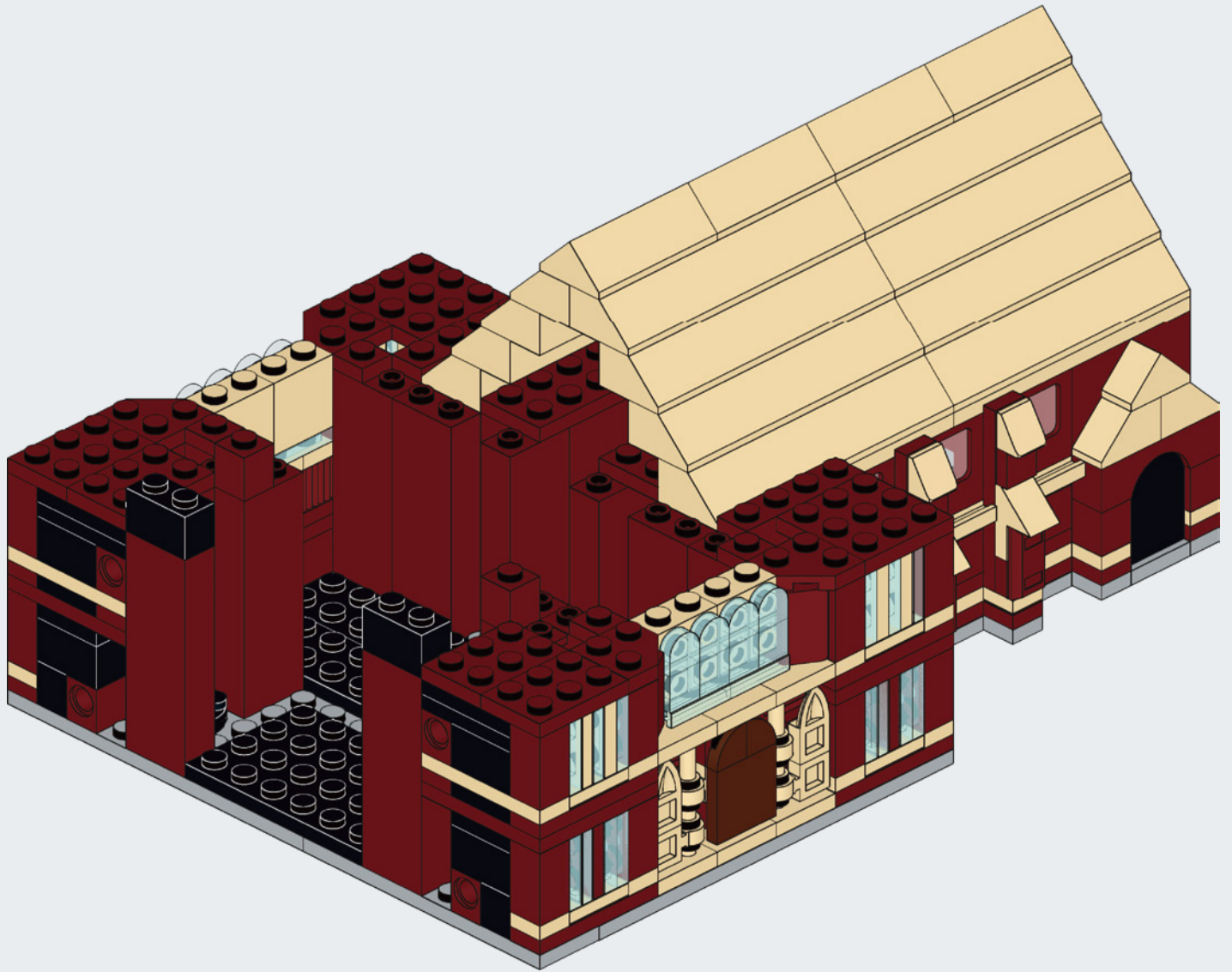

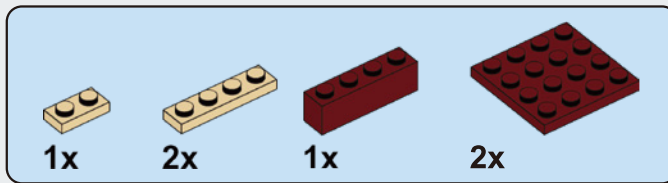
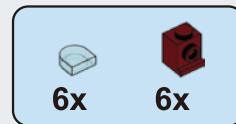
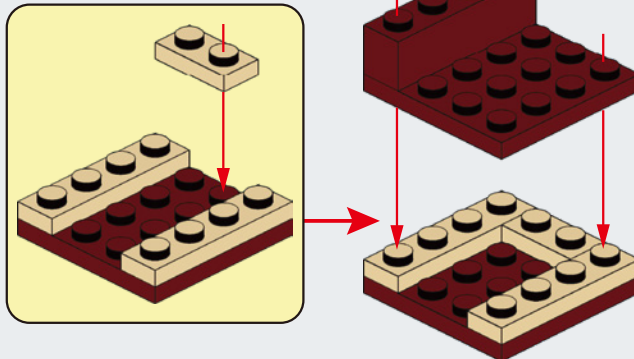
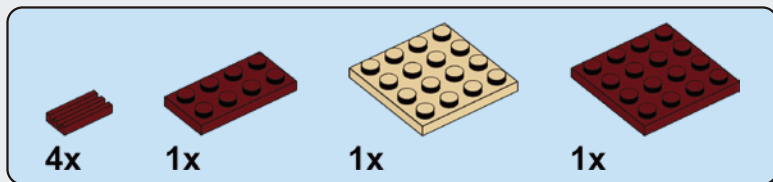
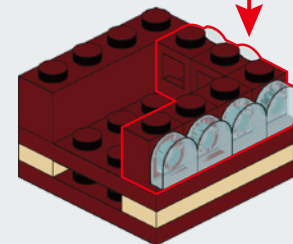
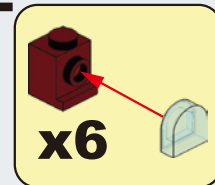
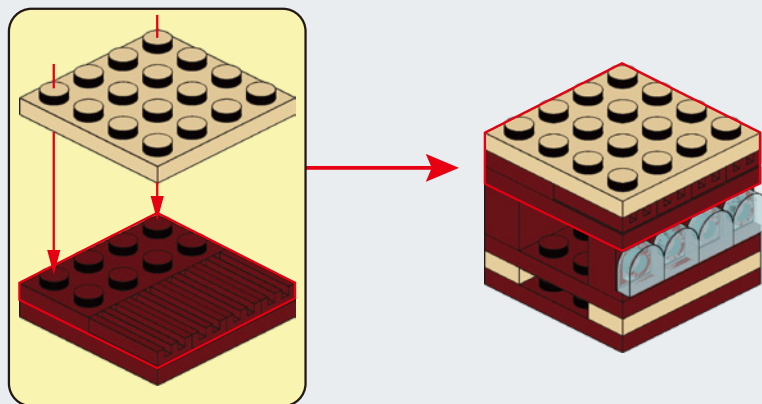
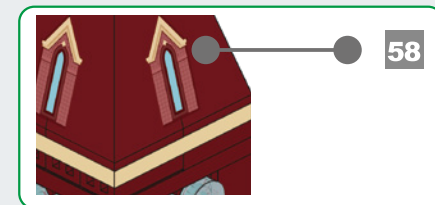
B**B1****B2****B3****B4**

57

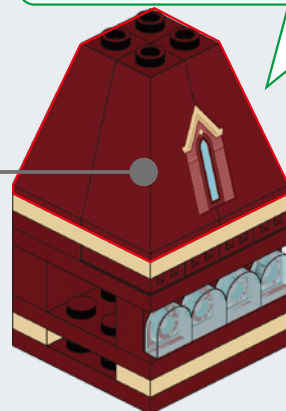

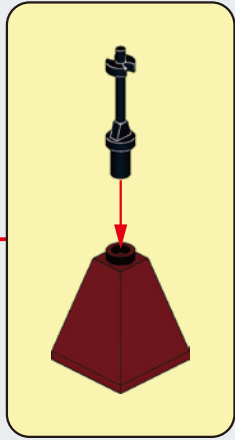
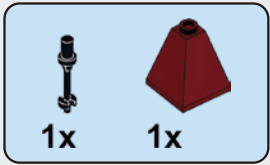

B5

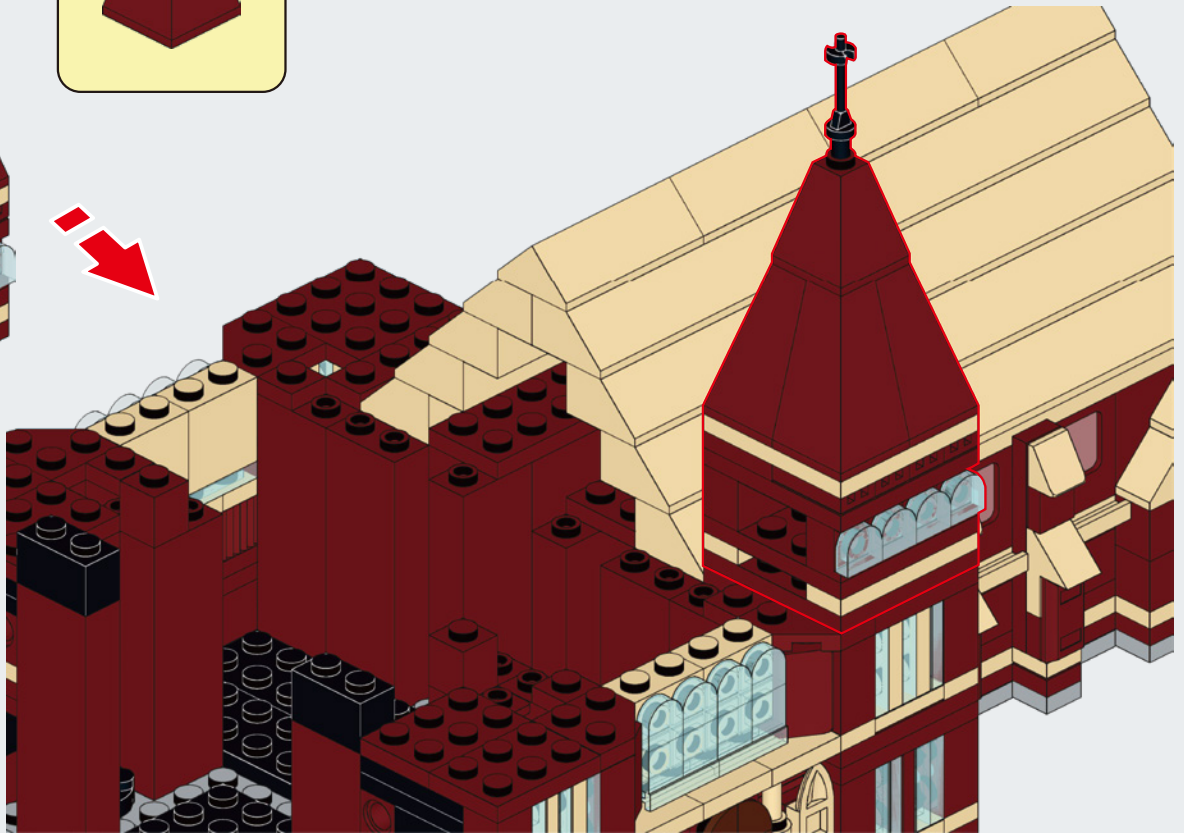
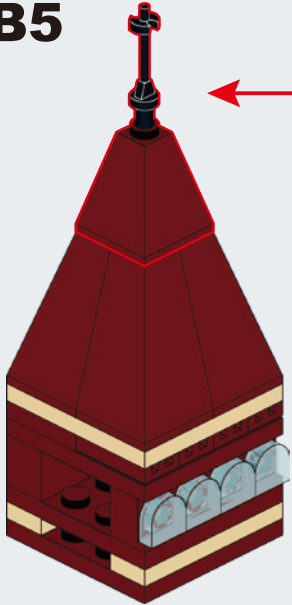

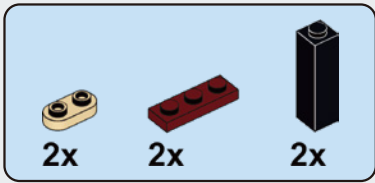

B6

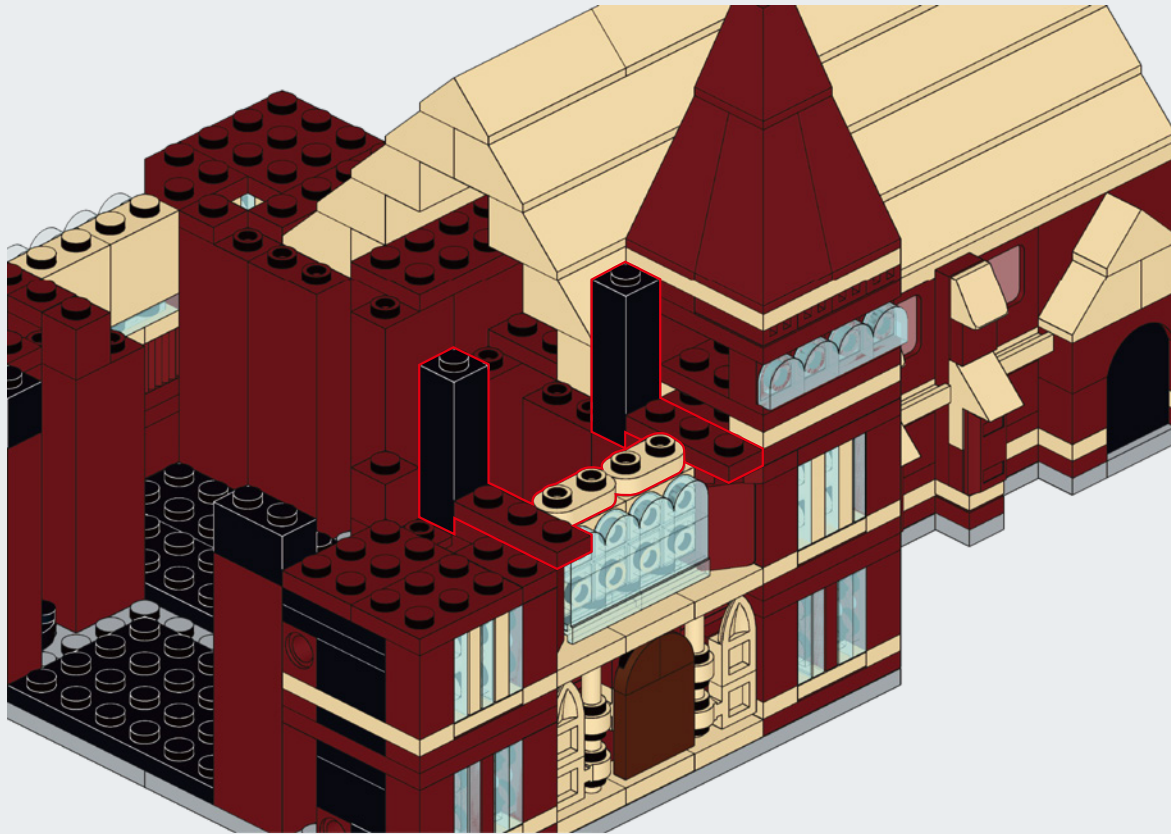

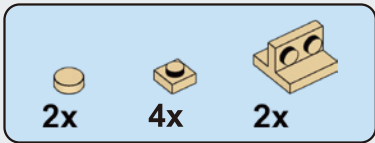

B7

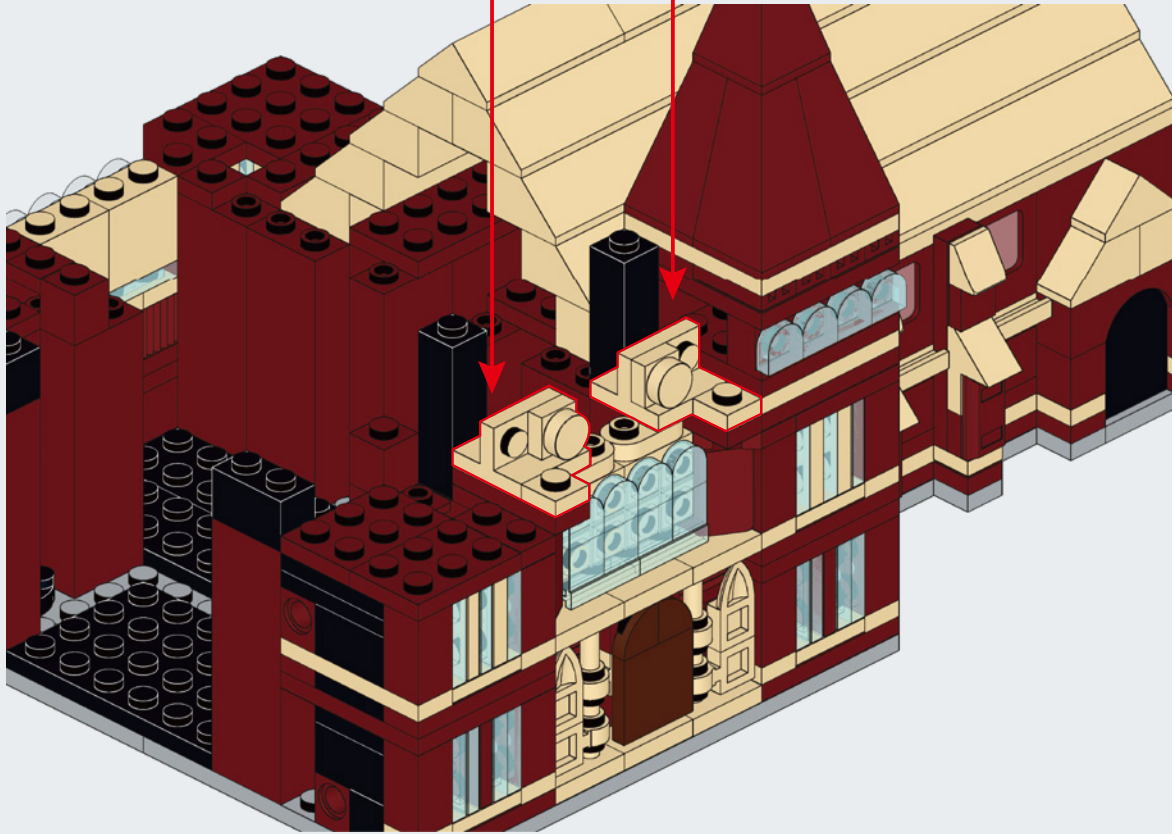
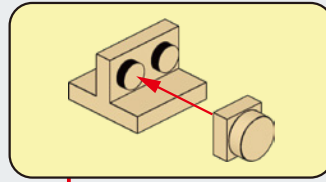
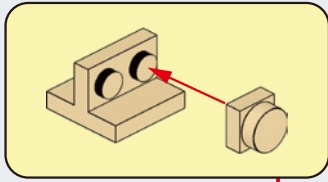

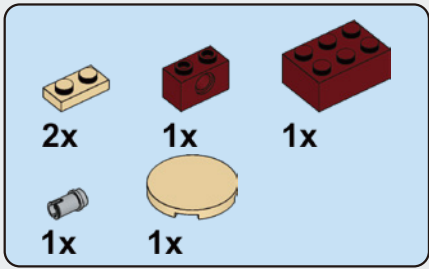

B8

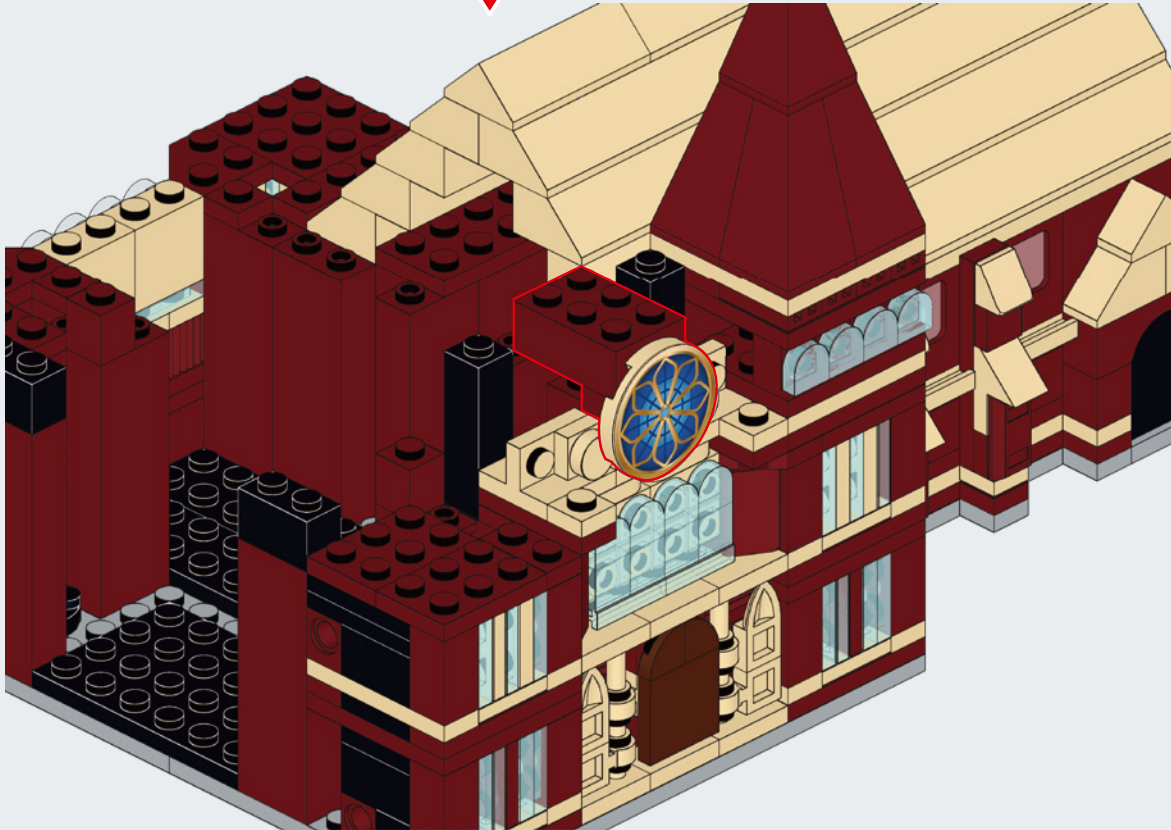
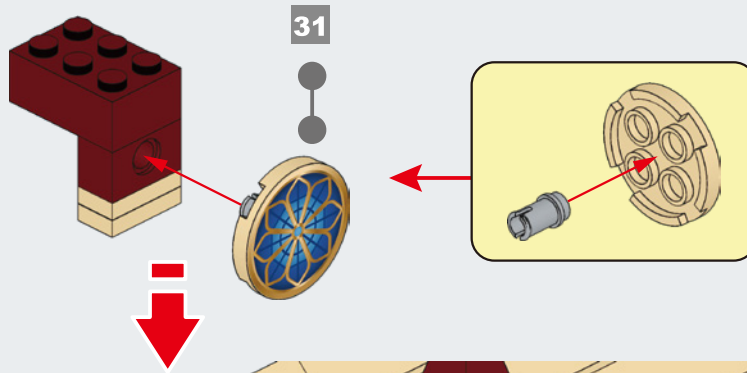

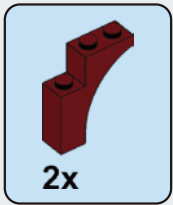

B9

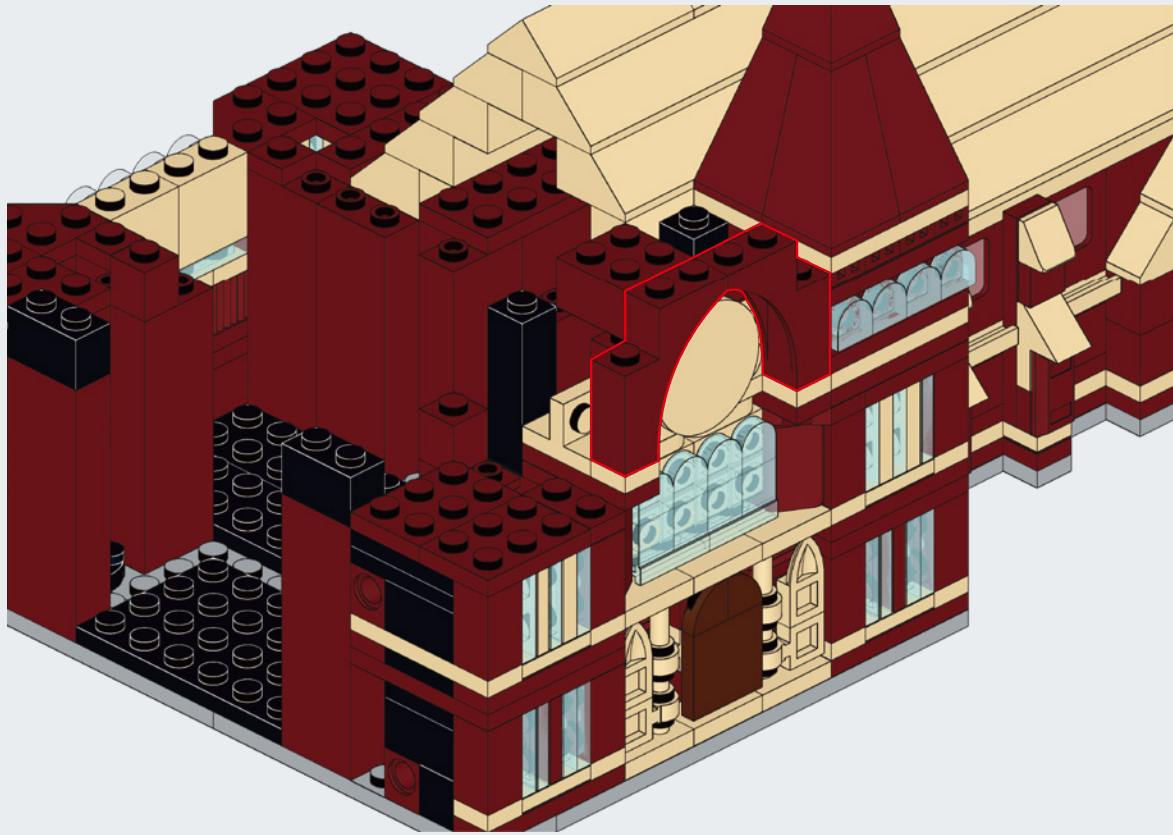

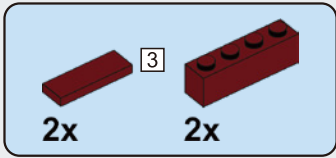

B10

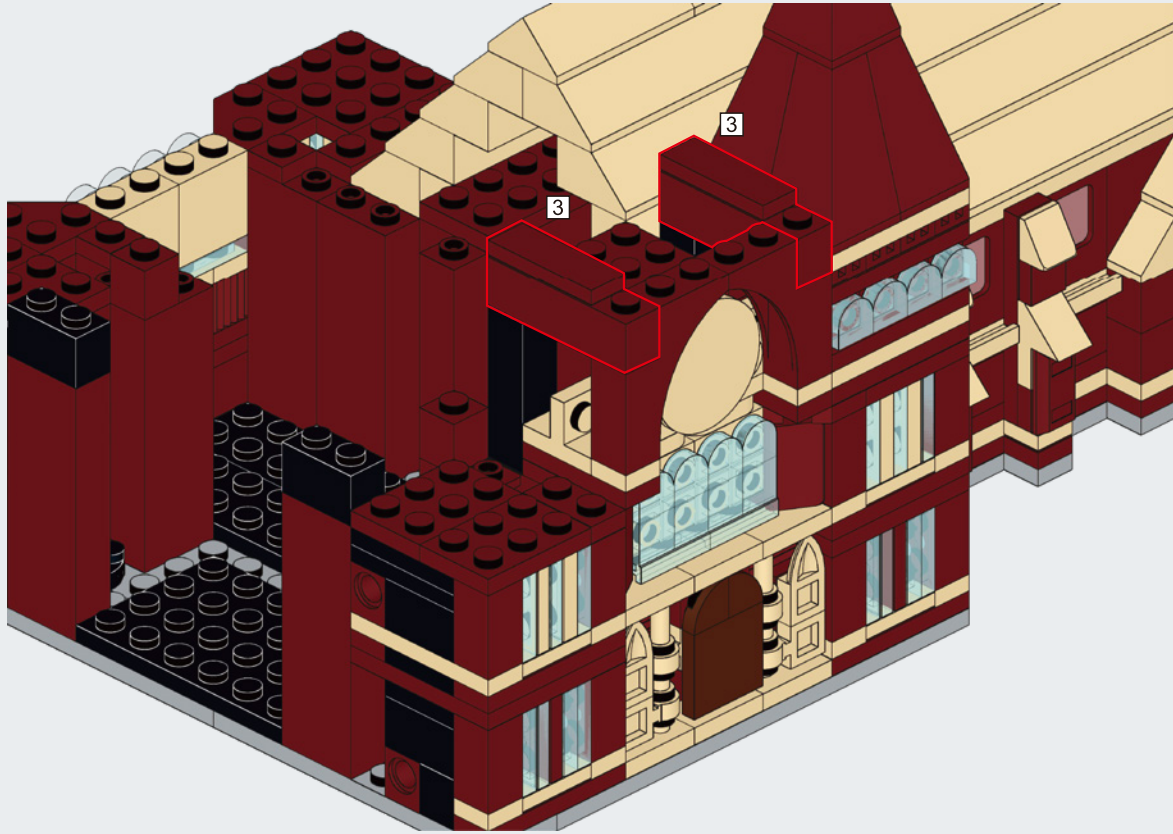

CaDA®



CaDA®

 www.doubleeagle-group.com

C66002



403ARC660170001

C66010



Harvard Memorial Hall

C66017

