

## 简介

“这似乎是阿拉丁式的创造——这些庄严的建筑在一夜之间兴起……这是美国企业准备给予和成为的具体象征。

*Edwin Gay, 前哈佛商学院院长, 奉献演讲, 1927年4月*

自1908年哈佛商学院(HBS)成立以来, 其创始人一直在努力解决有关学院的机构使命和大学环境中商业研究所固有的社会责任的问题。很快人们就发现, 这所学校占据了剑桥哈佛大学校园内遥远建筑的一部分, 需要一个更大的综合场地来维持其不断增长的学生人数。在纽约银行家George F. Baker的支持下, 在哈佛商学院院长Wallace B. Donham的指导下, 由McKim, Mead&White设计的新乔治亚校园于1927年完工, 位于查尔斯河畔。优雅、广阔的新校园不仅为学校提供了第一个真正的家, 而且帮助使新兴的工商管理学科合法化。



## INTRODUCTION

***“It seems to be an Aladdin-like creation—these stately buildings arising overnight . . . a symbol of what American business is prepared to give—and be.”***

*Edwin Gay, Former HBS Dean, Dedication Addresses, June 4, 1927*

From the incorporation of Harvard Business School (HBS) in 1908, its founders wrestled with questions regarding the School’s institutional mission and social responsibilities intrinsic to the study of business within the university setting. It soon became apparent that the School, which occupied parts of far-flung buildings on the Harvard grounds in Cambridge, would require a larger, integrated site to sustain its growing student population. With the support of New York banker George F. Baker and the guidance of HBS Dean Wallace B. Donham, construction of the neo-Georgian campus, designed by McKim, Mead & White and located on the banks of the Charles River, was completed in 1927. The graceful, expansive new campus not only gave the School its first real home, but helped legitimize the fledgling discipline of business administration.



## 发展历程

**MBA**

**1908**

哈佛大学经营研究生院成立(世界首个MBA课程)拥有15名教师,33名普通学生和47名特殊学生

**PhD  
DBA**

**1922**

设立博士课程

**HBR**

**1922**

《哈佛商业评论》创刊



**1924**

案例法被确立为主要教学方法



**1924**

商学院校园建成

**Exec  
ED**

**1945**

举办第一届高管教育计划(高级管理计划)——由六十名高管和最近复员的退伍军人组成。



**1959**

哈佛-拉德克利夫工商管理课程的女毕业生被MBA课程的第二年录取



**1993**

哈佛商业出版社成立并作为哈佛大学的全资子公司



**1997-2017**

全球研究中心在硅谷开业; 在亚太地区(1999年)、拉丁美洲(2000年)、日本(2002年)、欧洲(2003年)、印度(2006年)、伊斯坦布尔(2013年)和约翰内斯堡(2017年)开设了其他区域研究中心



**2013**

创立哈佛商学院在线版

## KEY START DATES

**MBA**

**1908**

**Harvard Graduate School of Business Administration** established (the world's first MBA program) with a faculty of 15, 33 regular students, and 47 special students.

**PhD  
DBA**

**1922**

**The Doctoral Program** was established.

**HBR**

**1922**

**The Harvard Business Review** was founded.



**1924**

**The case method** was established as the primary method of instruction.



**1924**

**Business school campus** constructed.

**Exec  
ED**

**1945**

**First executive education program (Advanced Management Program)** held — a group of sixty executives and recently demobilized veterans.



**1959**

**Women** graduates of the Harvard-Radcliffe Program in Business Administration were admitted to the second year of the MBA program.



**1993**

**Harvard Business Publishing** was formed as a wholly owned subsidiary of Harvard University.



**1997-2017**

**Global Research Centers** opened in Silicon Valley; other regional research centers were opened in Asia-Pacific (1999), Latin America (2000), Japan (2002), Europe (2003), India (2006), Istanbul (2013), and Johannesburg (2017).



**2013**

**Founded Harvard Business School Online.**

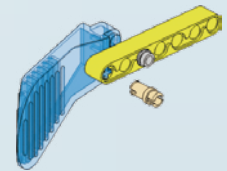
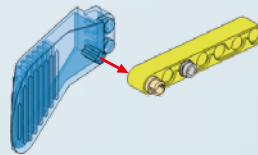
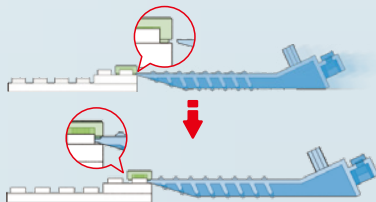
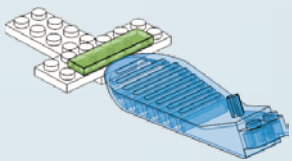
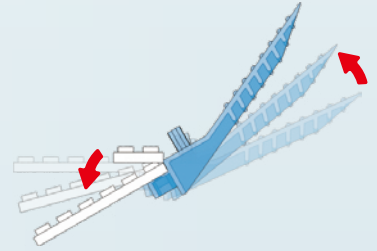
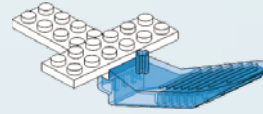
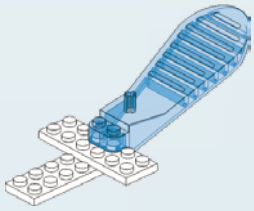

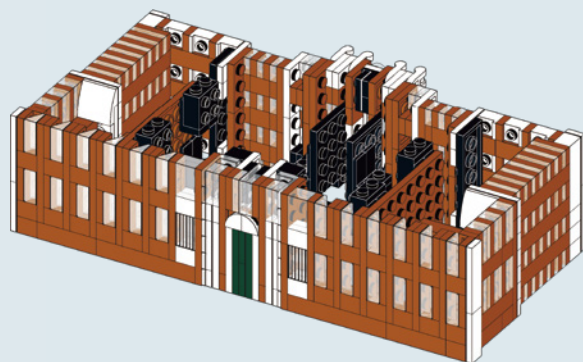

**A**

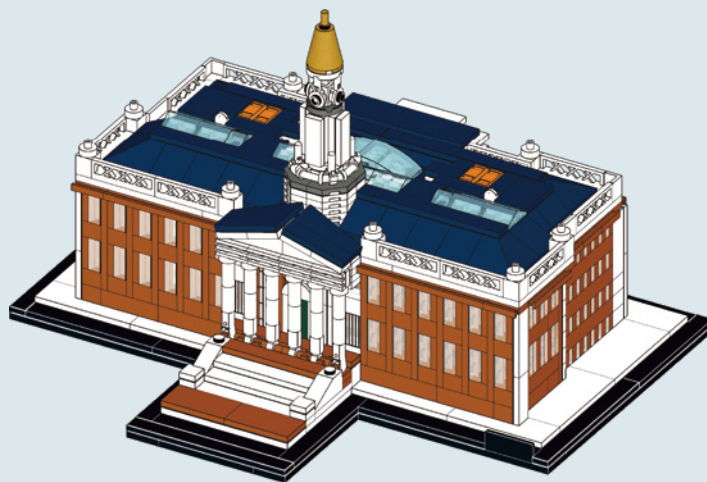

**B**

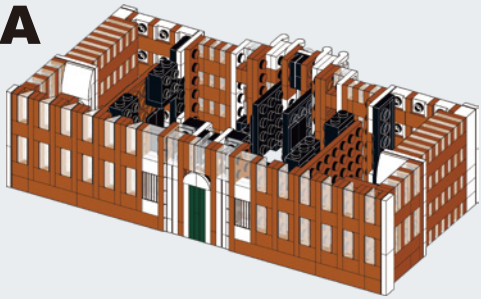
**A**

  
2x

  
2x

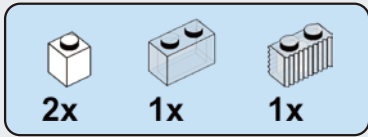
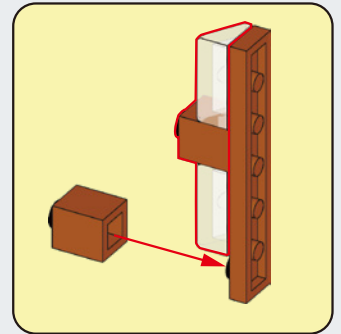
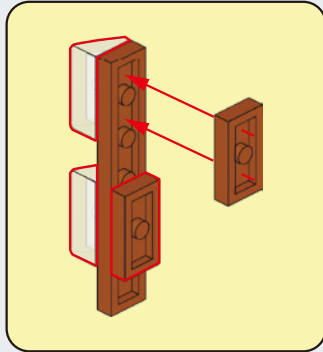

  
4x

  
2x
**A1**

2x

1x

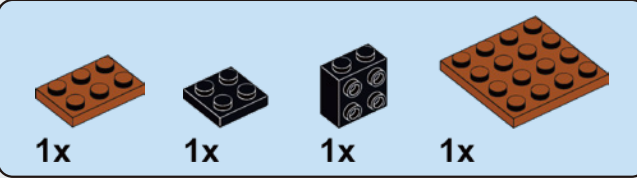
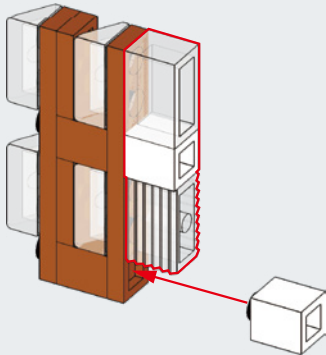
1x

**A2**

1x

1x

1x

1x

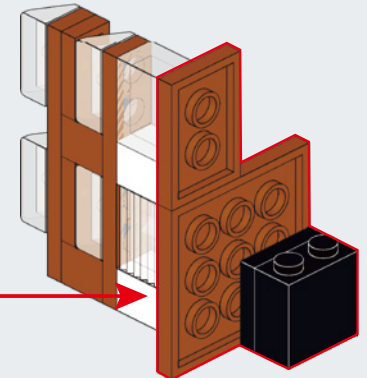
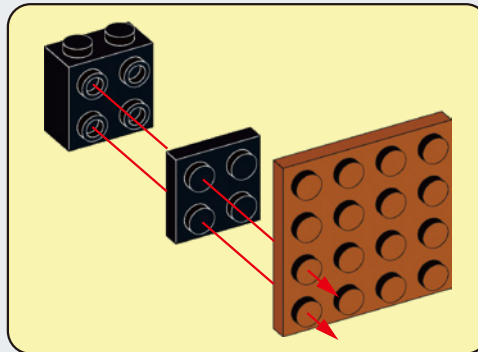
**A3**

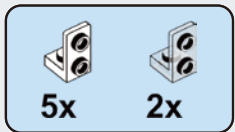

## A4

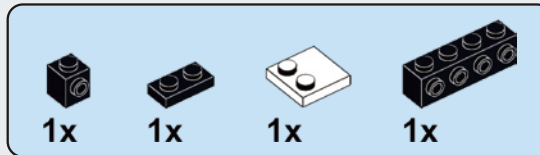
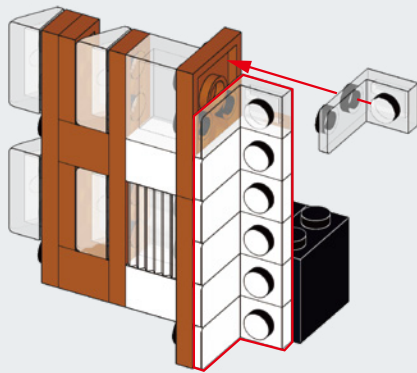

## A5

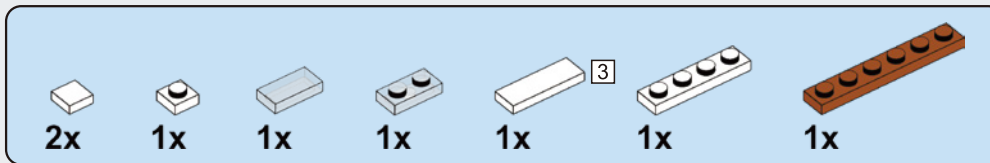
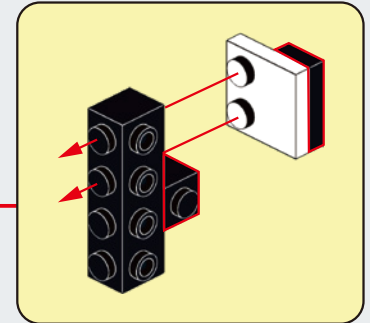
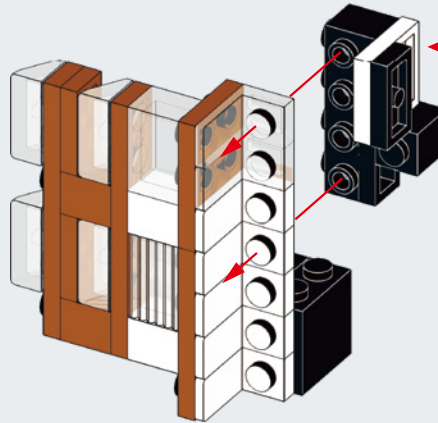

## A6

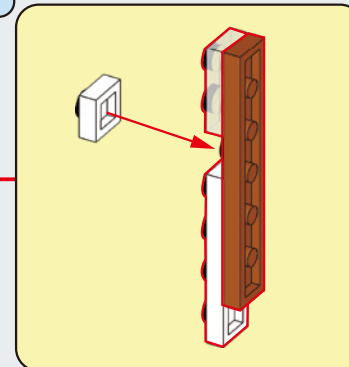
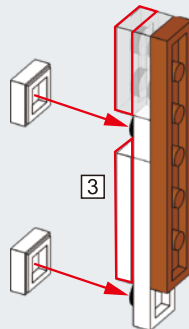



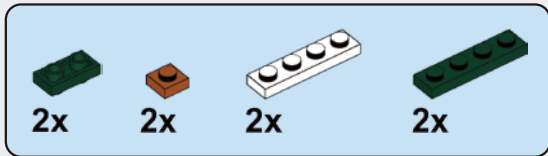

**A7**

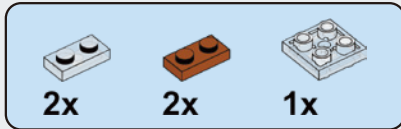
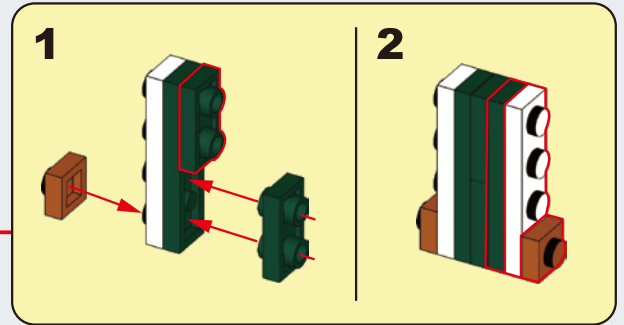
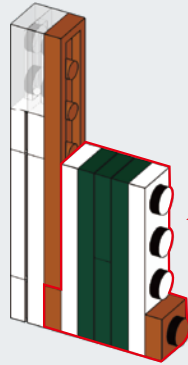

**A8**

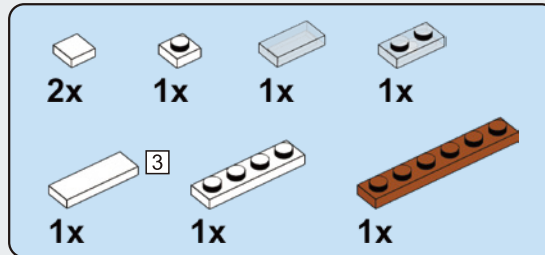
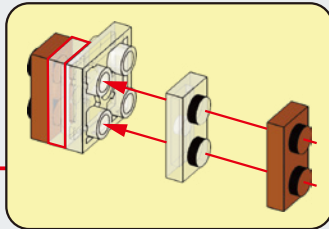
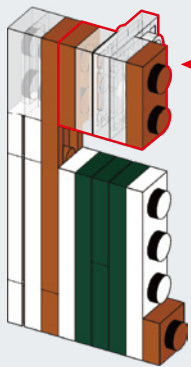

**A9**

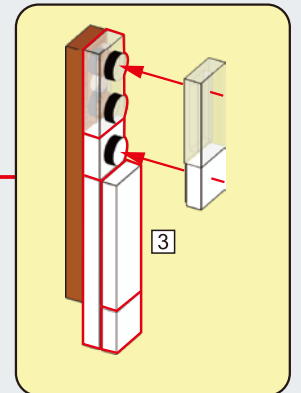
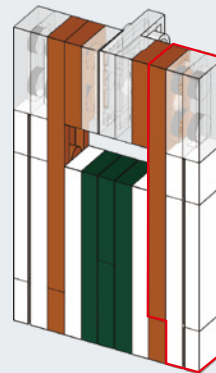

# A10

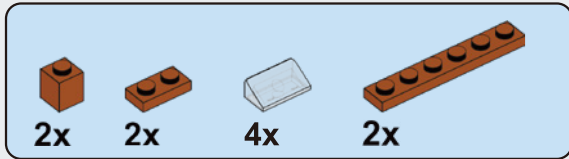
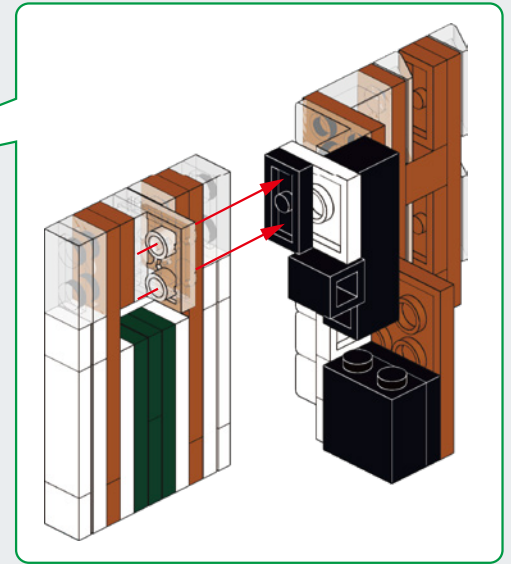
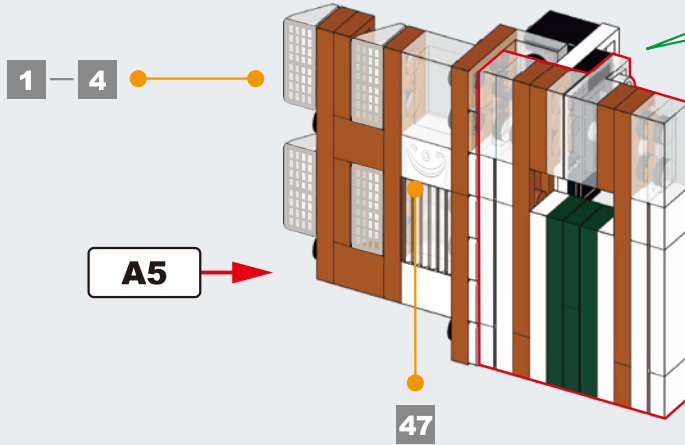

# A11

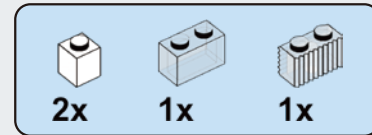
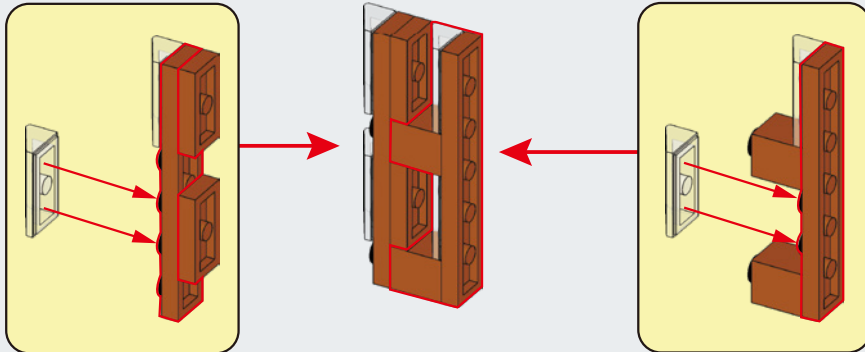

# A12

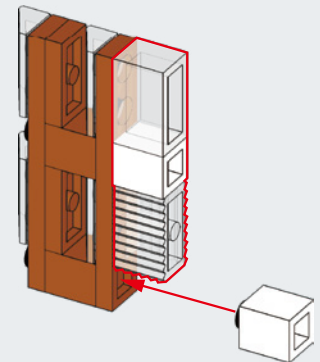

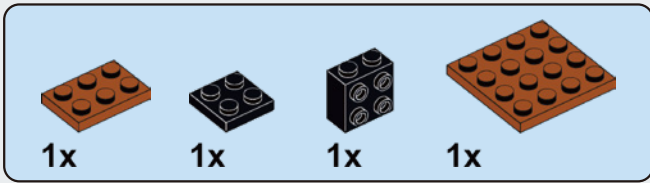

# A13

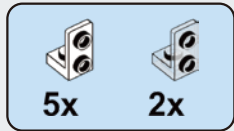
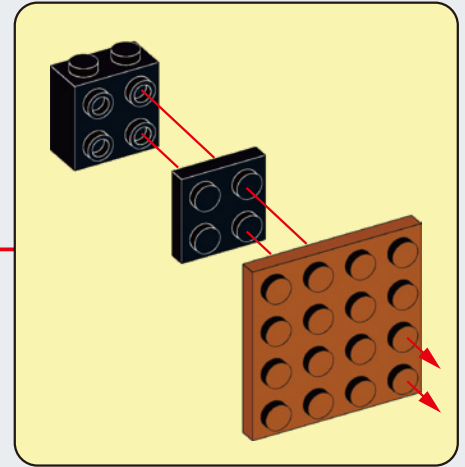
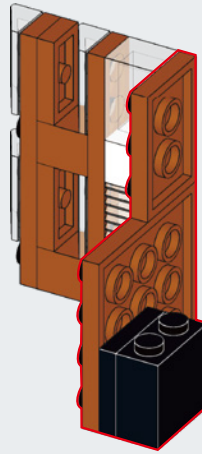

# A14

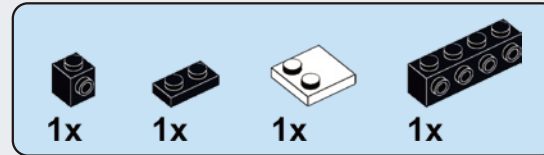
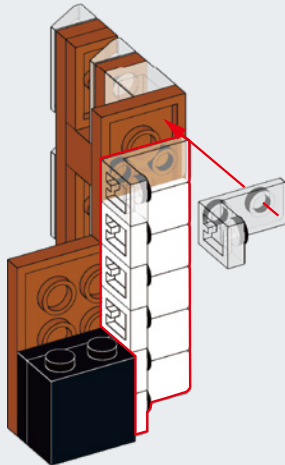

# A15

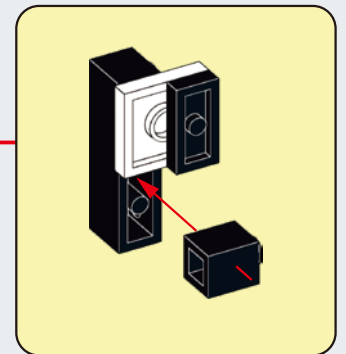
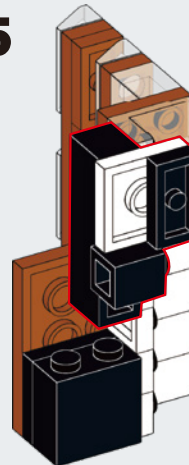

# A16

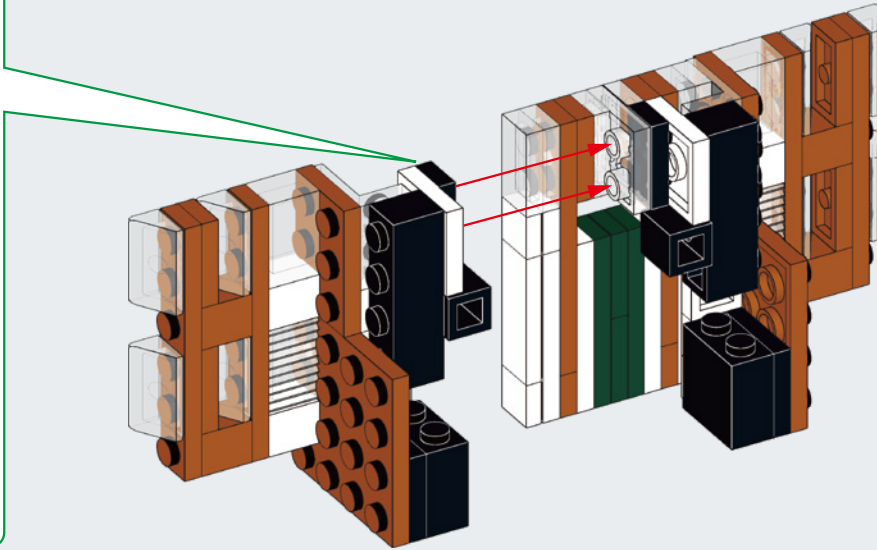
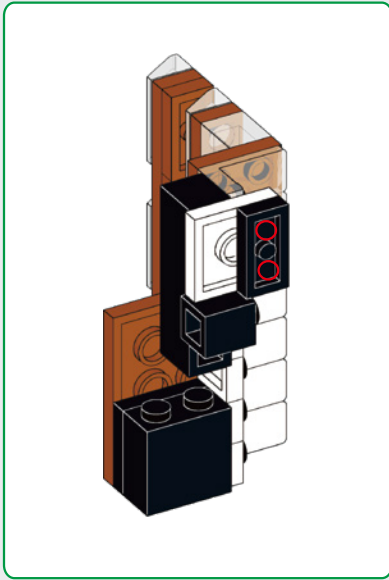

**A10**

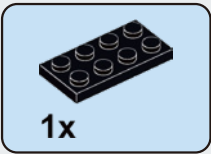

# A17

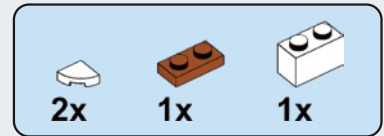
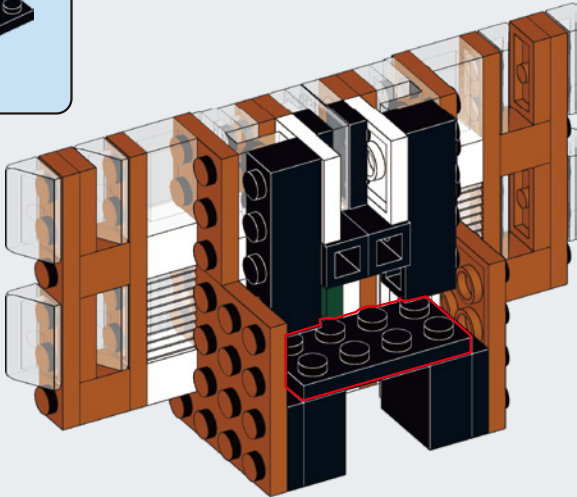

# A18

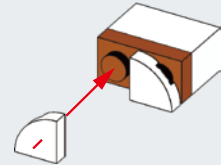

# A19

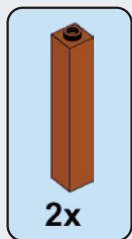
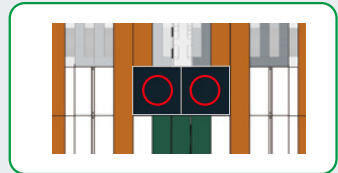
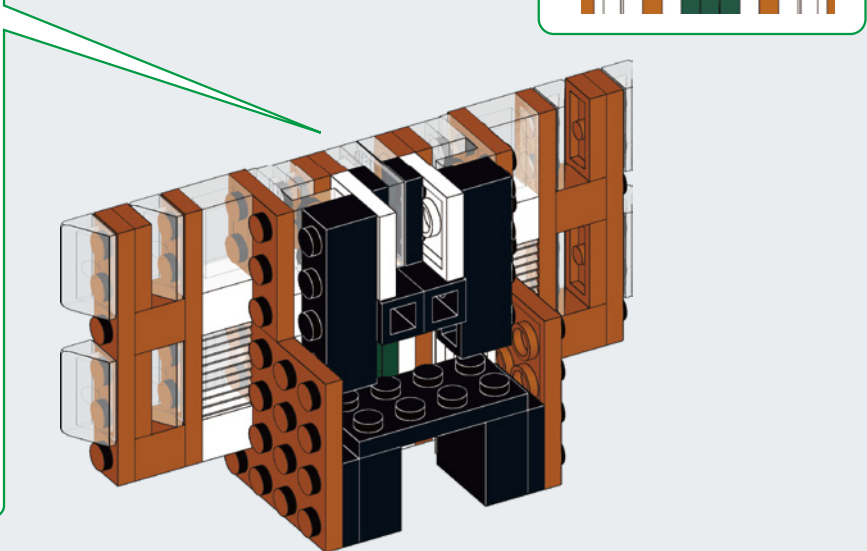
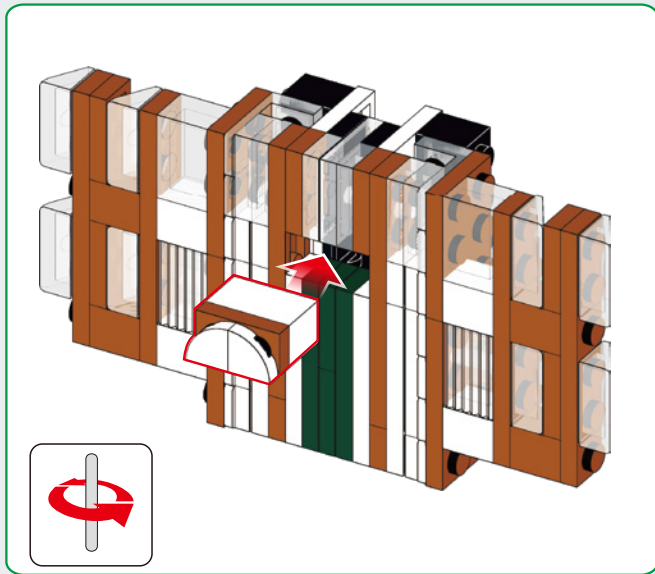

# A20

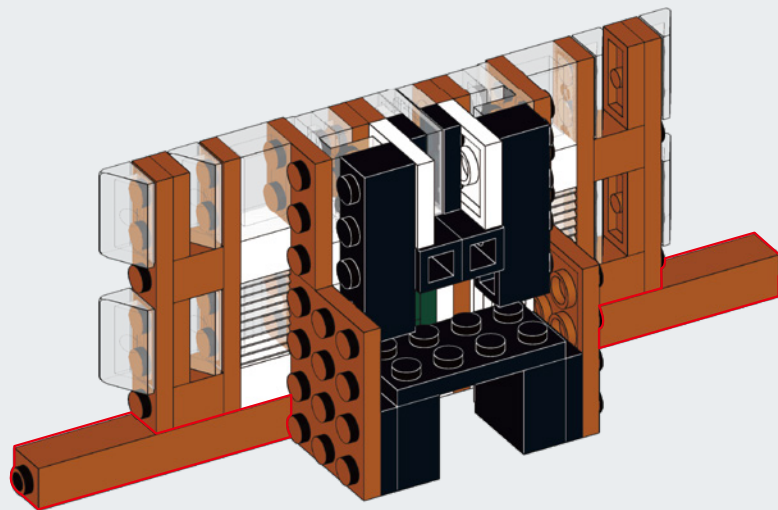

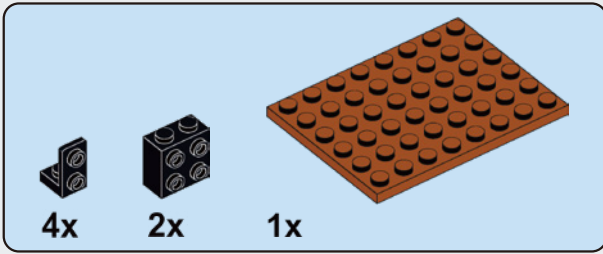

**A21**

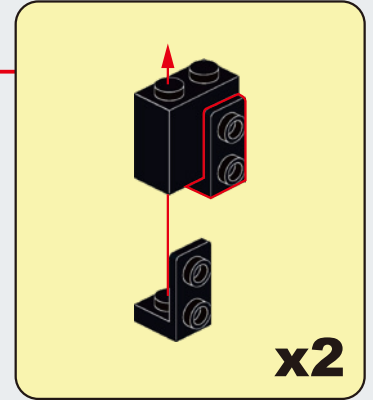
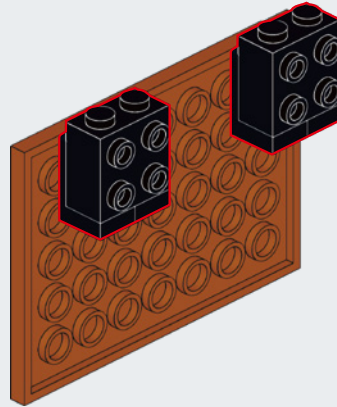
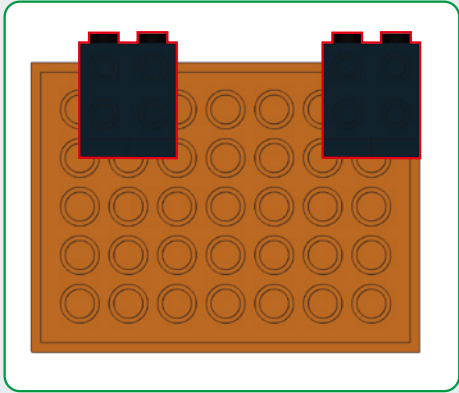

**x2**

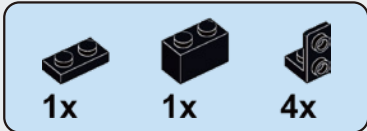

**A22**

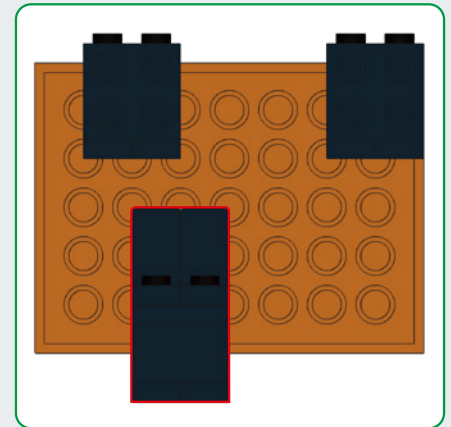
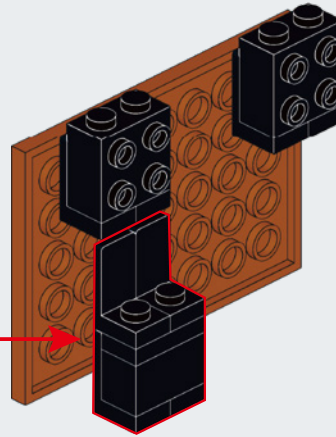
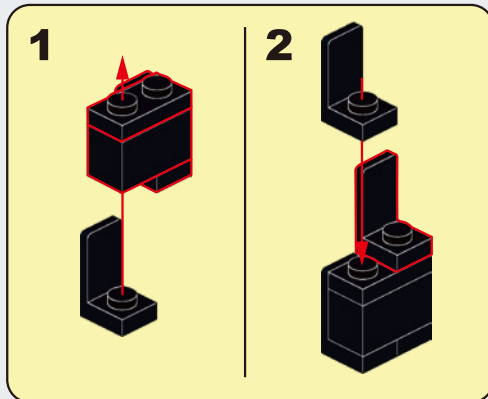

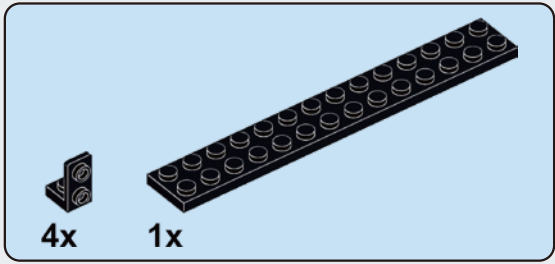

**A23**

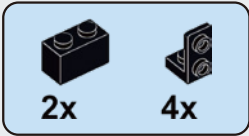
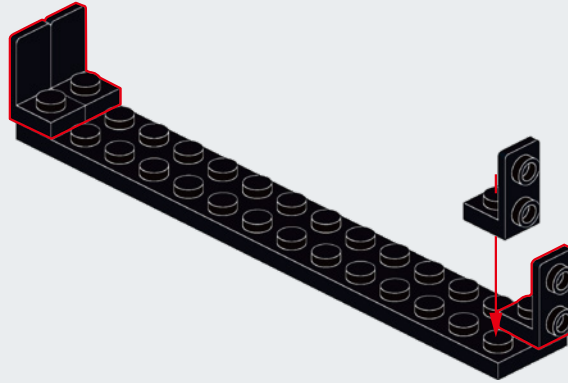

**A24**

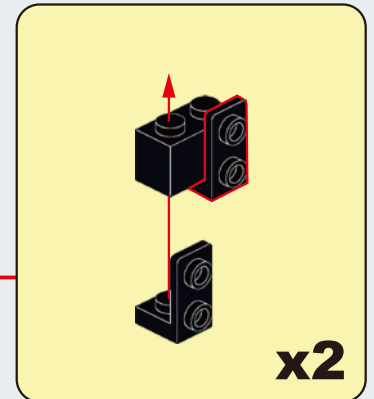
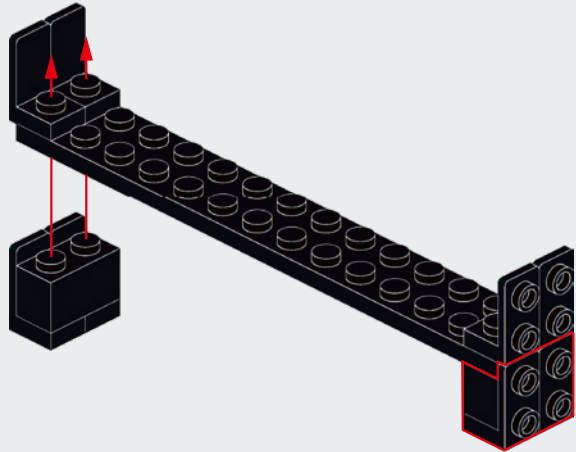

# A25

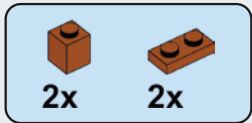
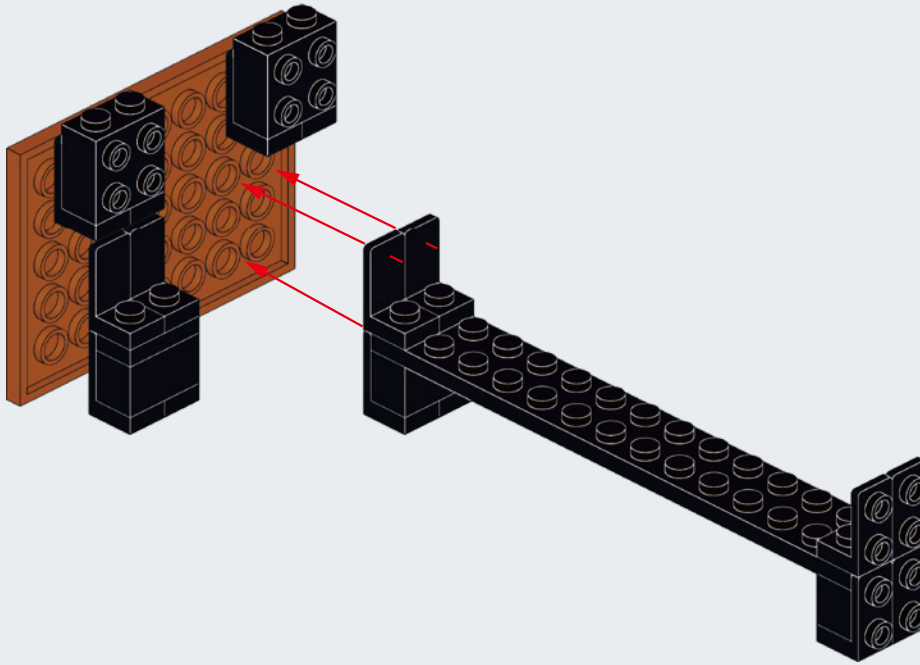

# A26

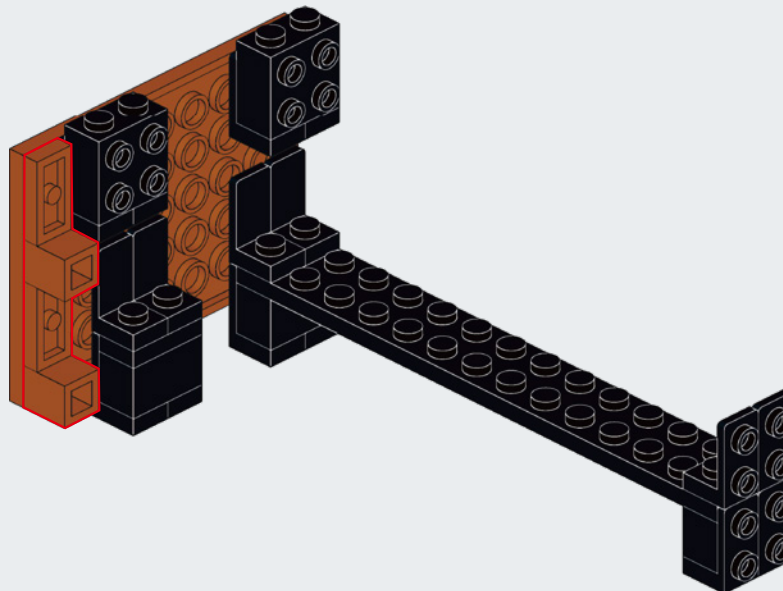



**A27**

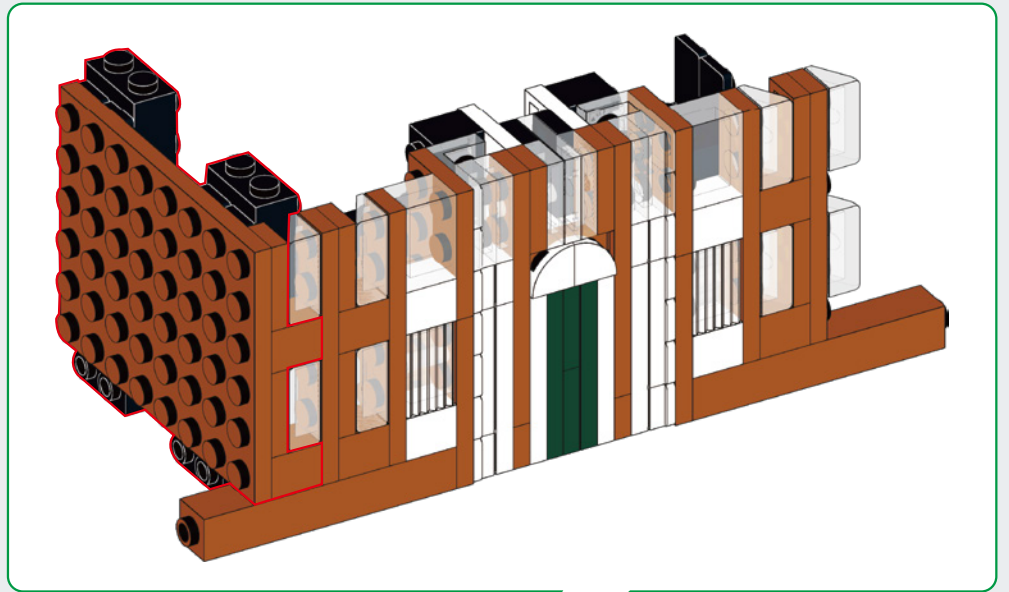

**A20**

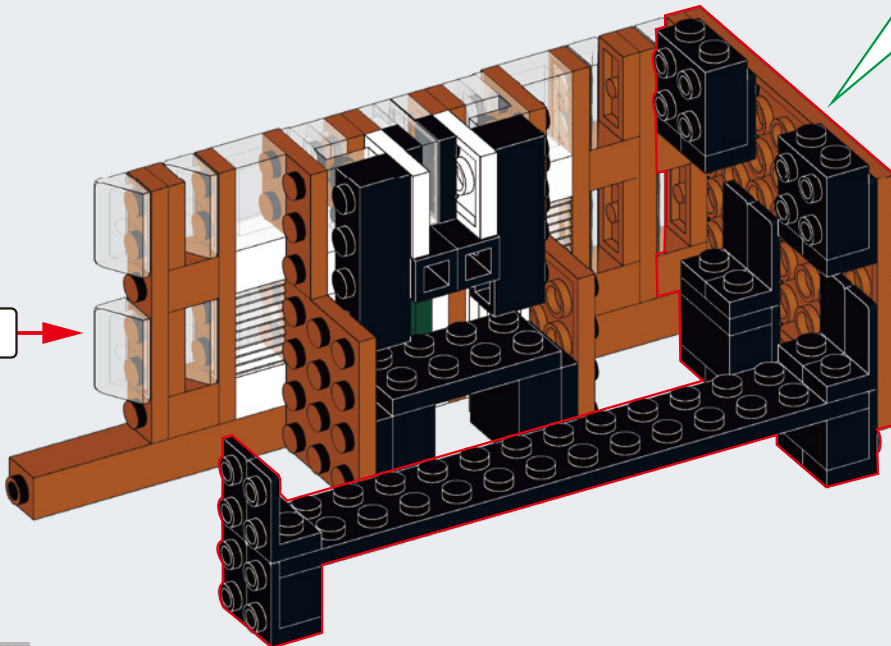

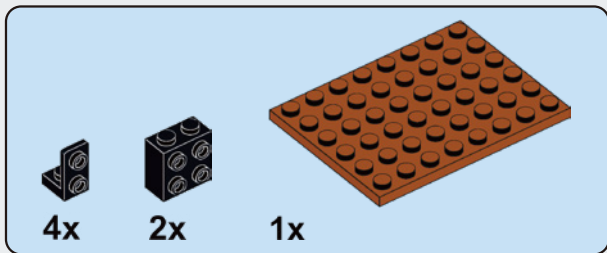

**A28**

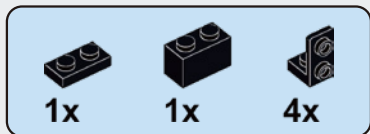
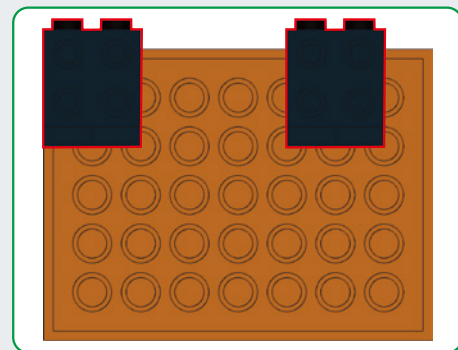
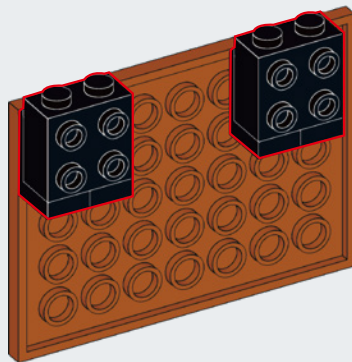
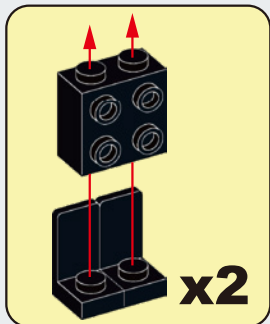

**A29**

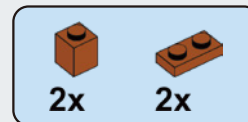
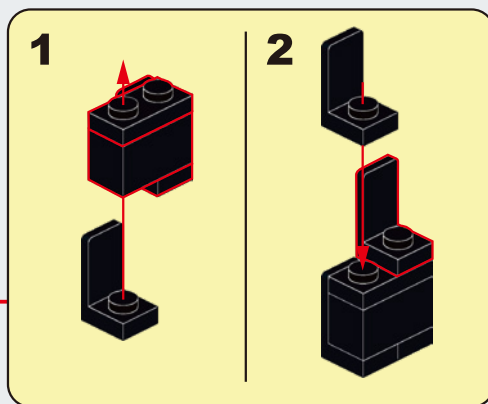
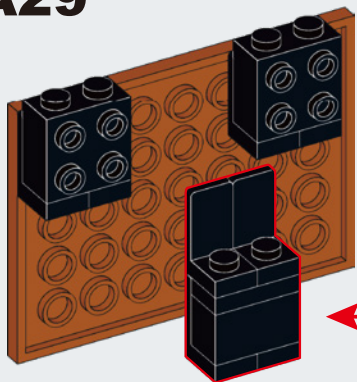

**A30**

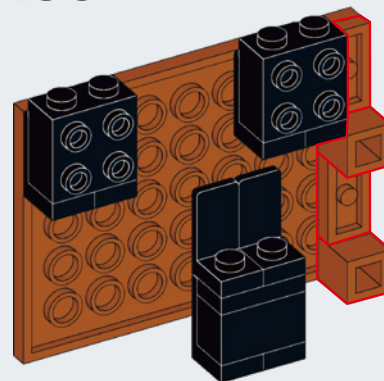

# A31

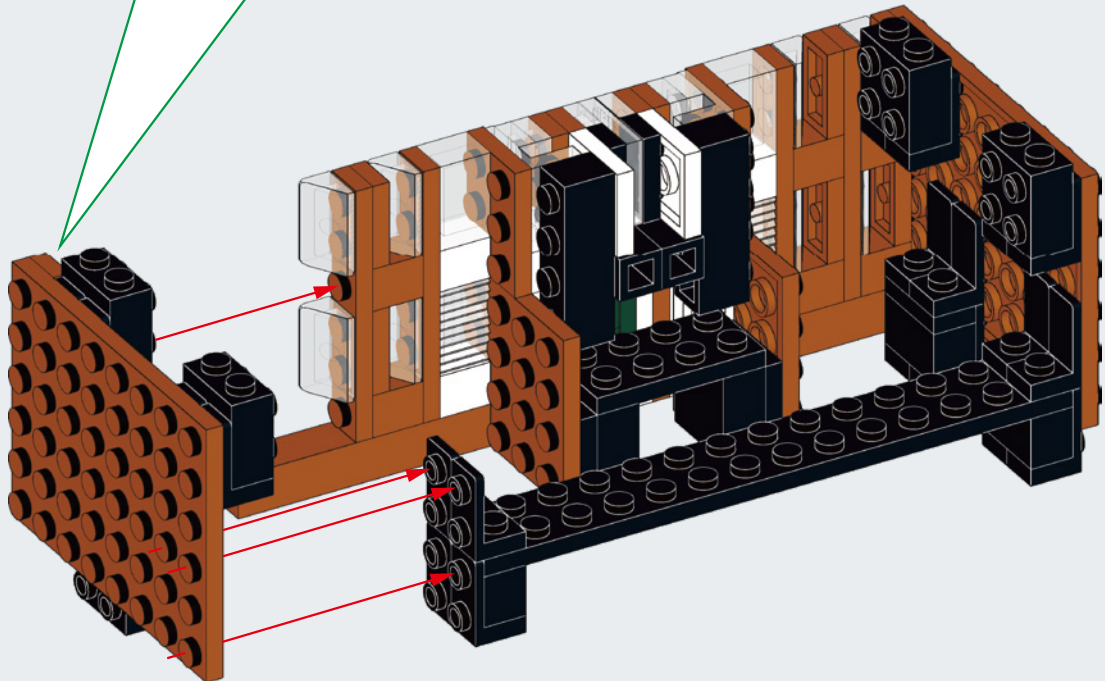
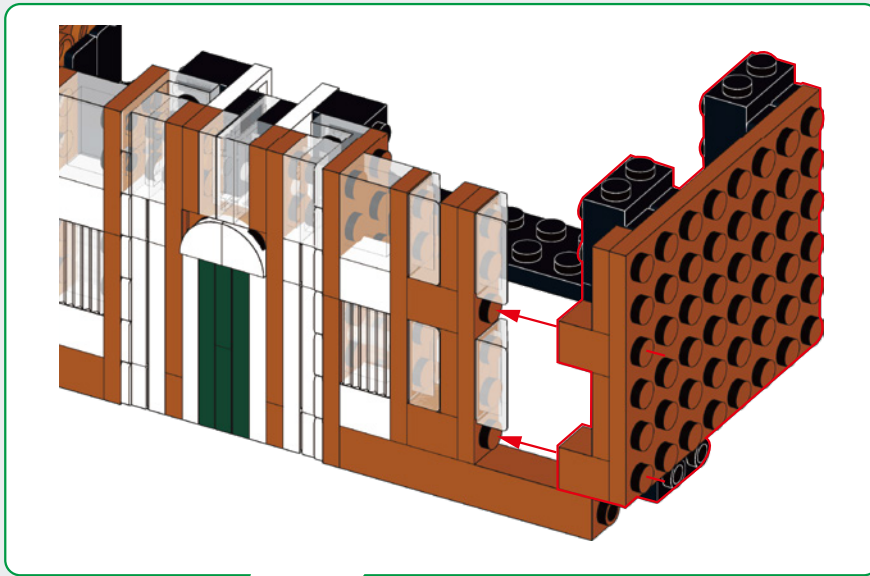

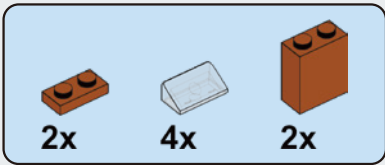

# A32

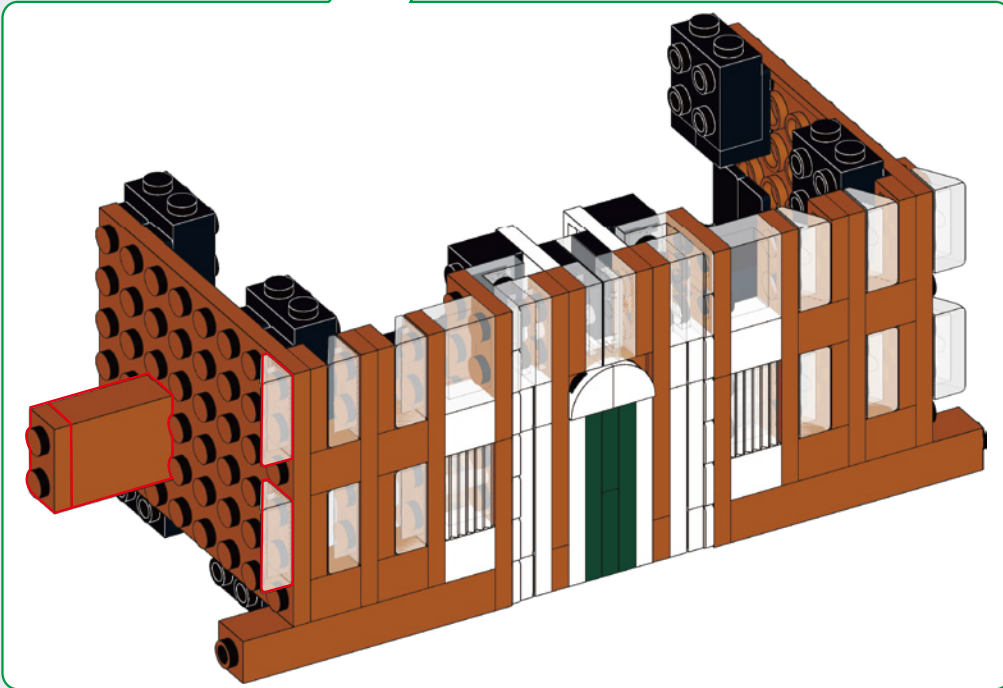
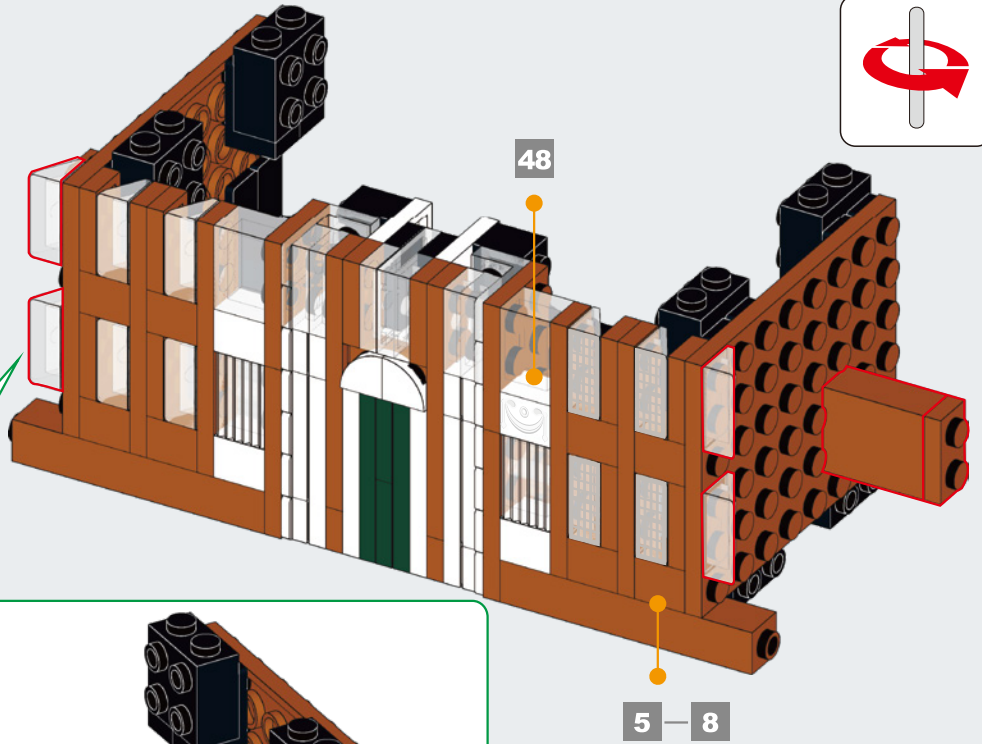
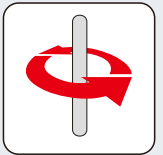

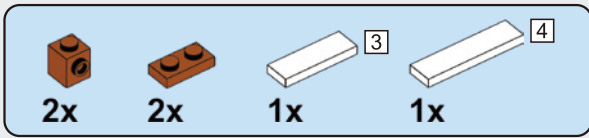

## A33

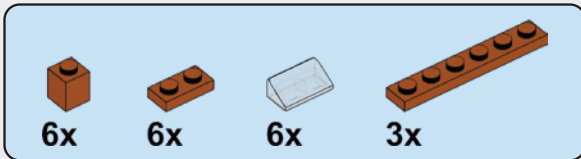
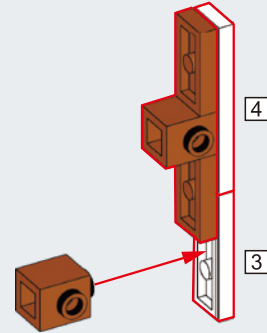

## A34

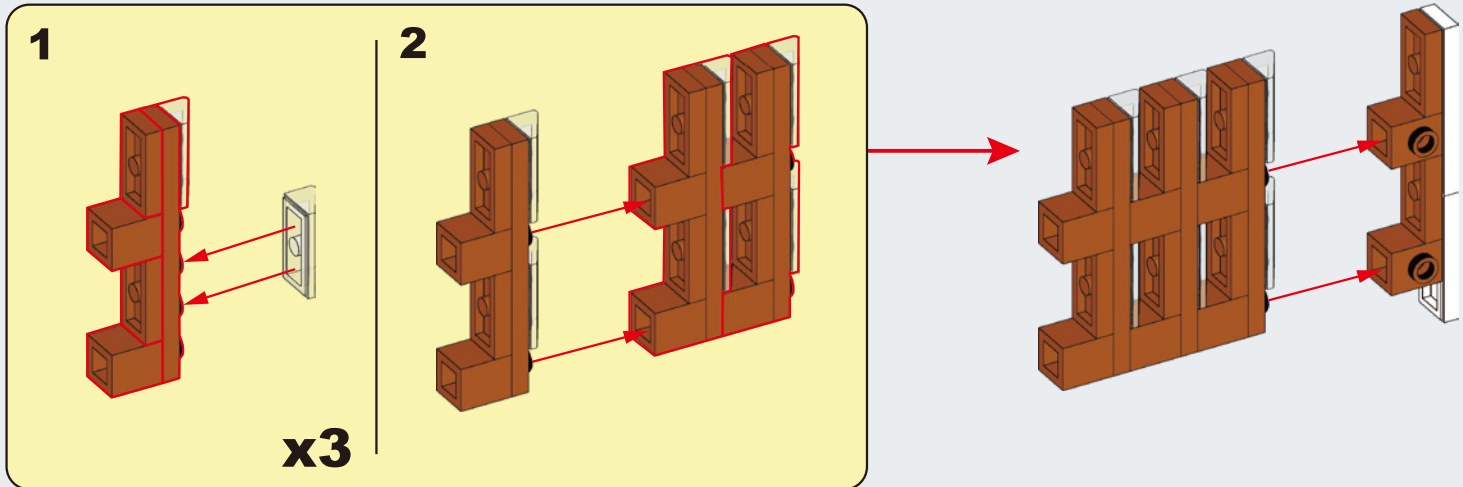

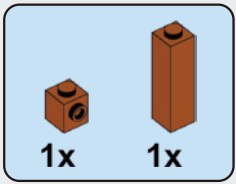

# A35

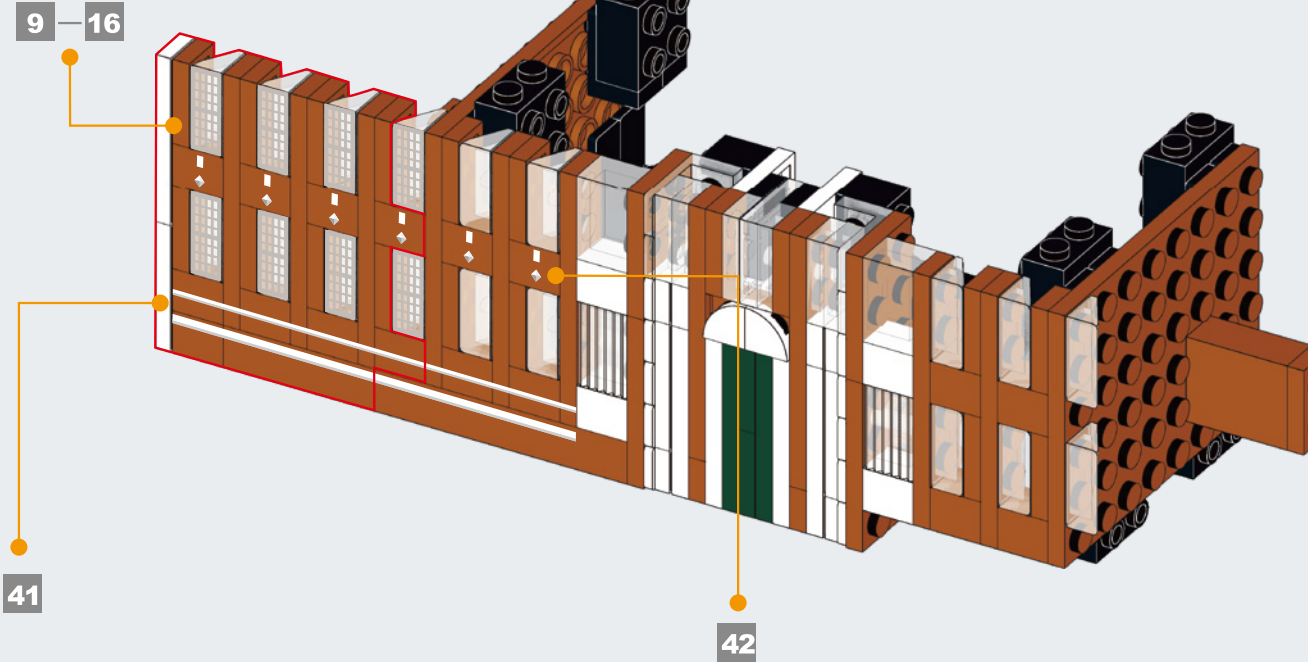
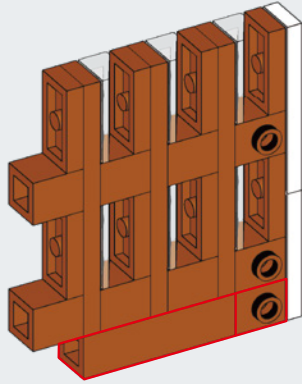

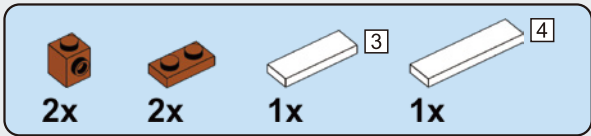

## A36

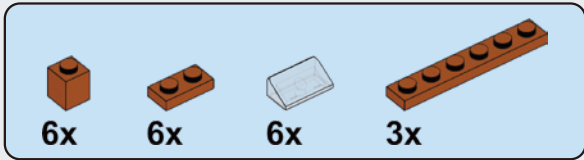
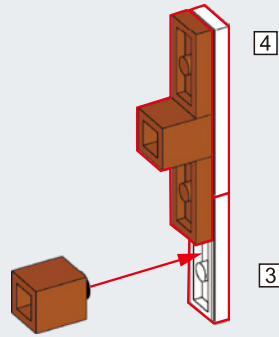

## A37

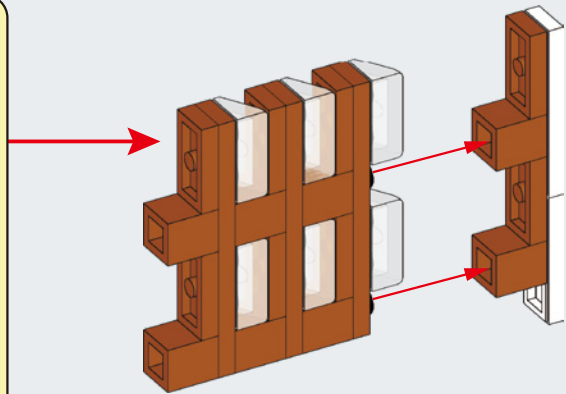
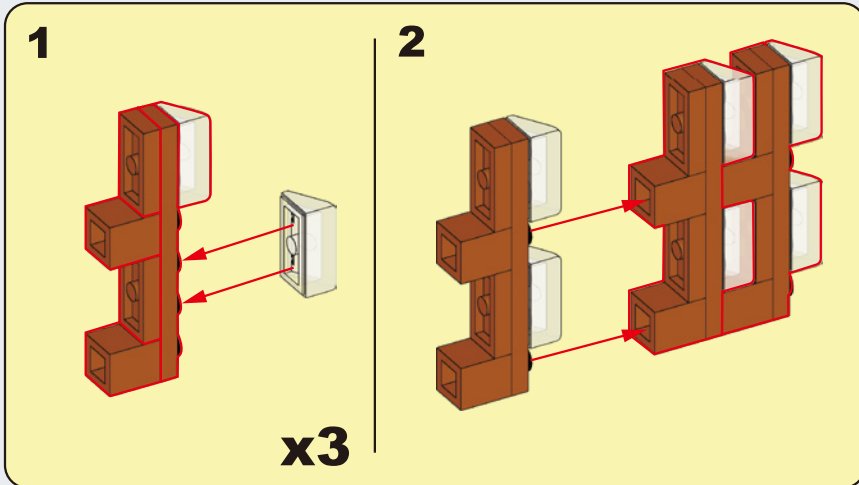

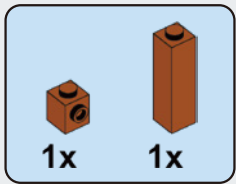

# A38

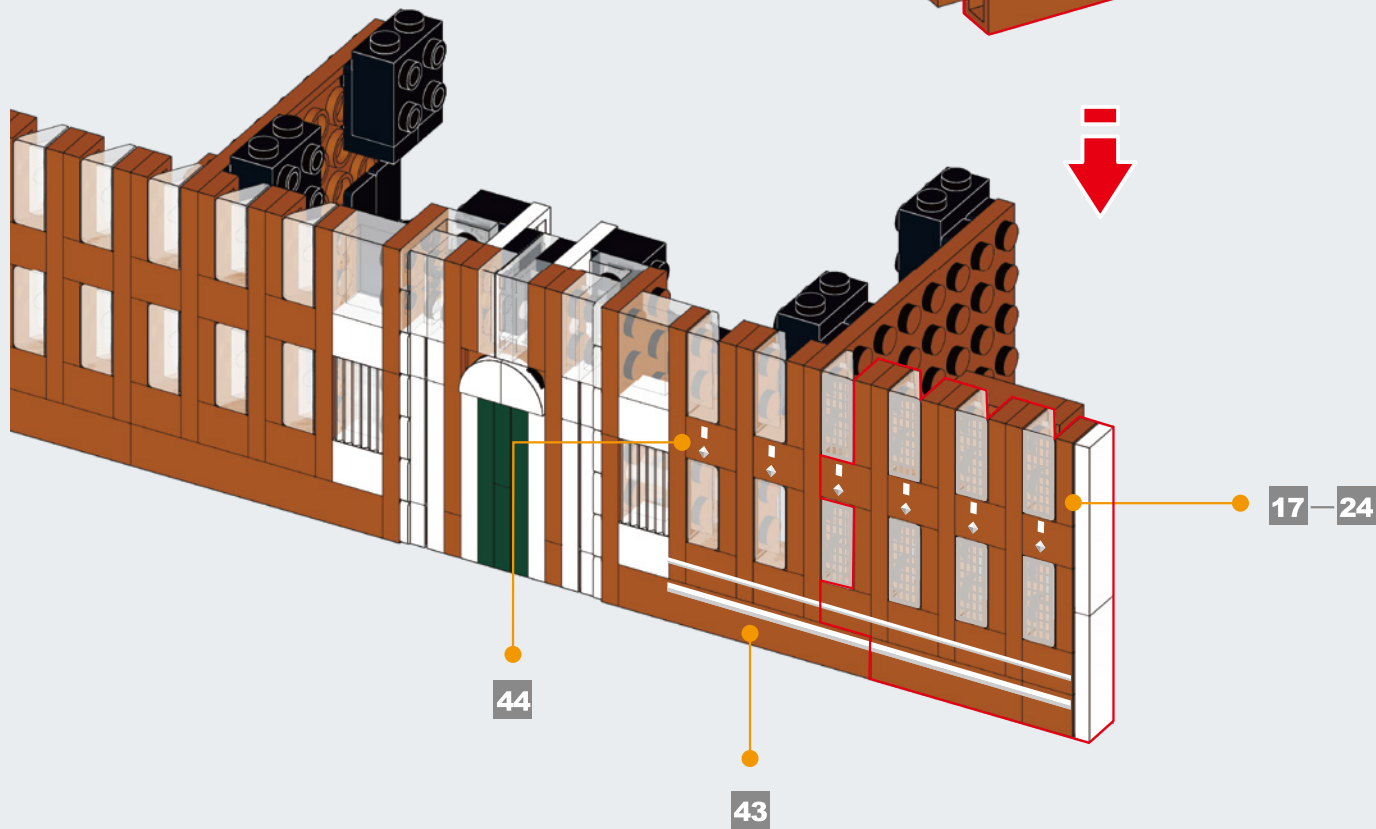
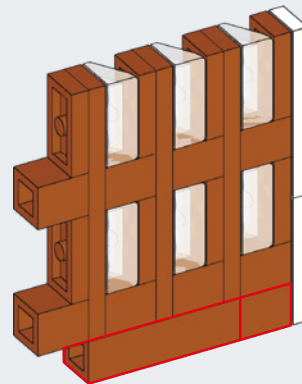



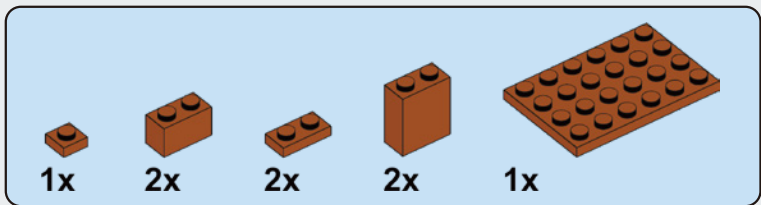

**A39**

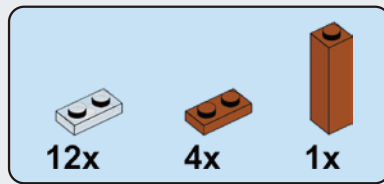
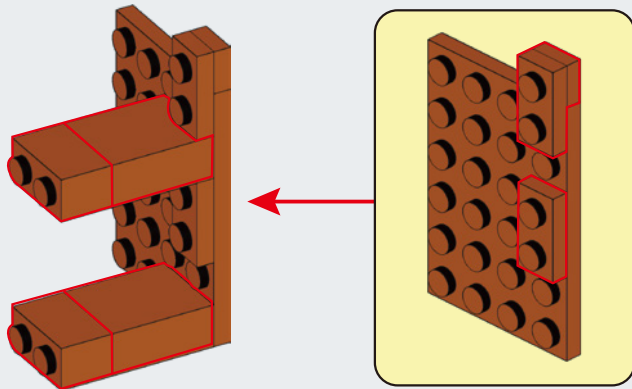

**A40**

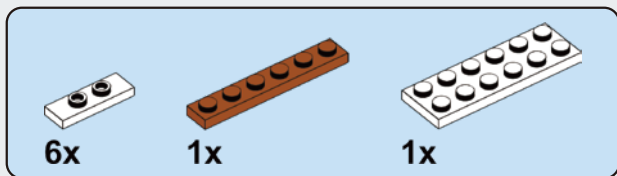
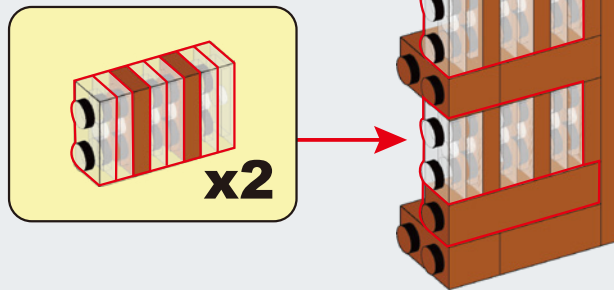

**A41**

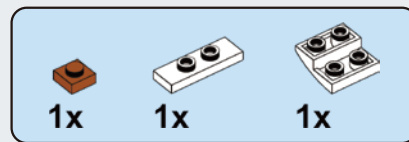
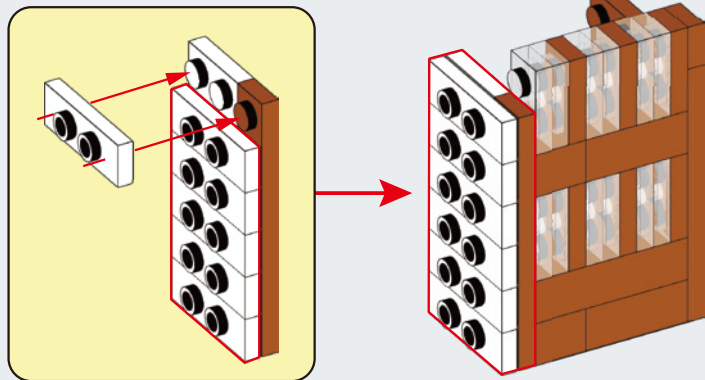

**A42**

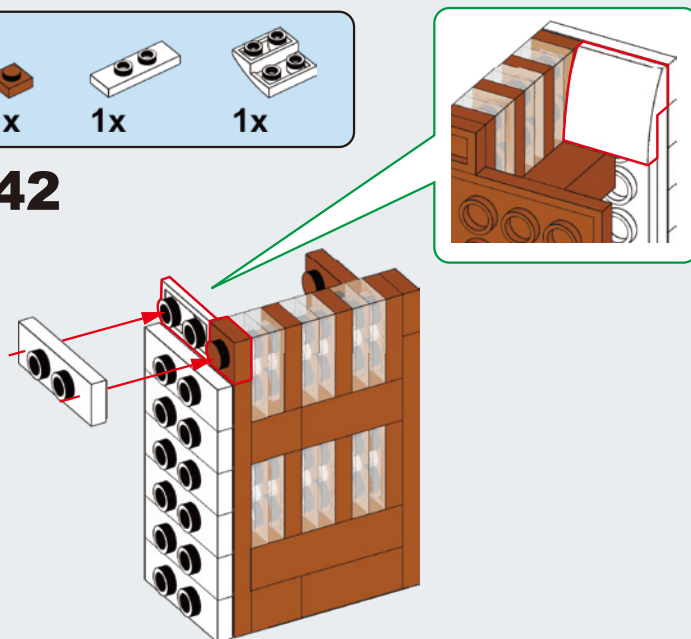

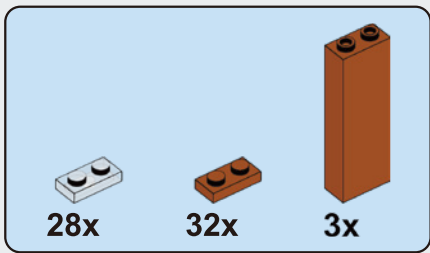

**A43**

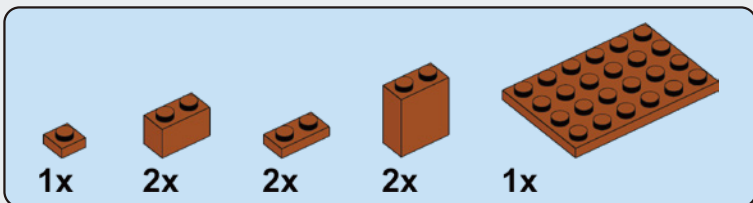
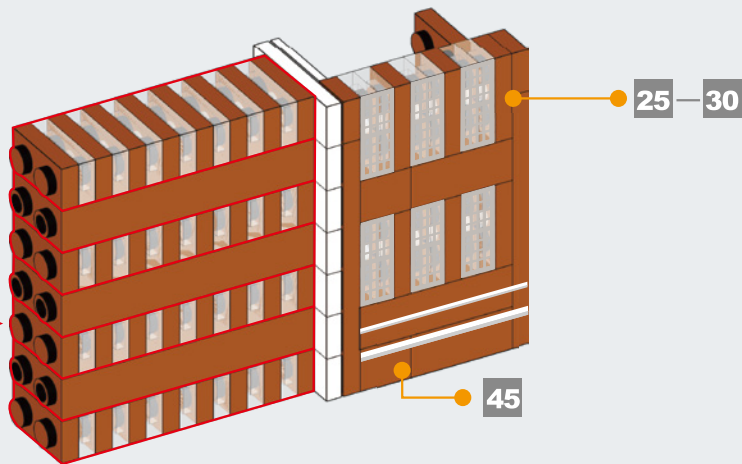
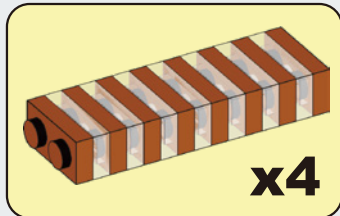

**A44**

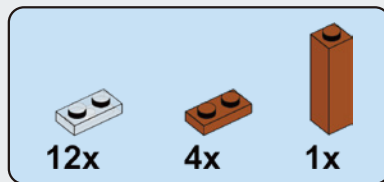
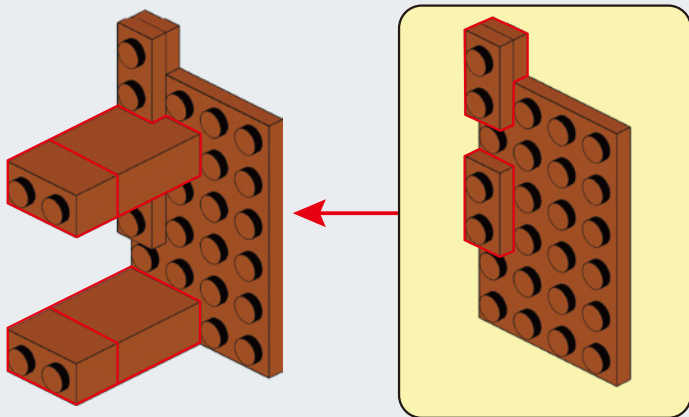

**A45**

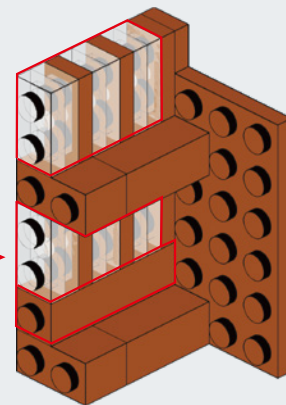
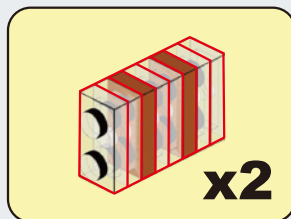

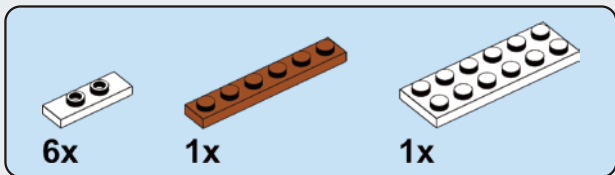

## A46

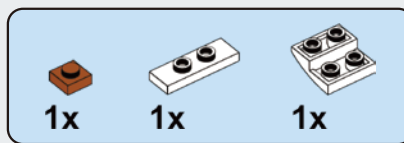
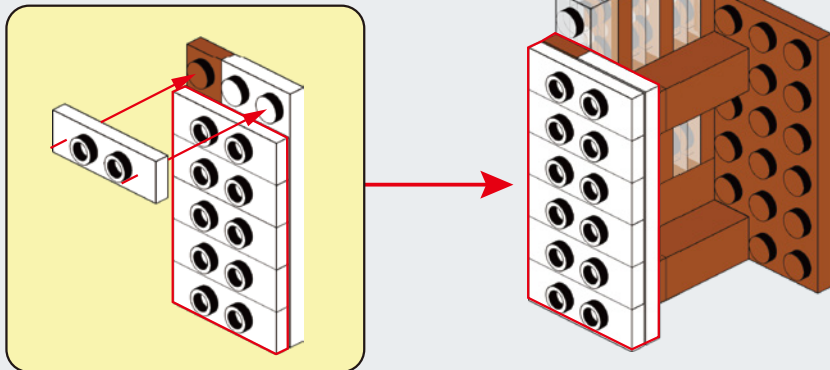

## A47

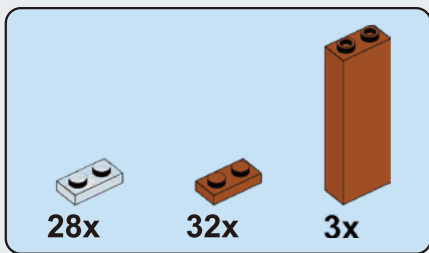
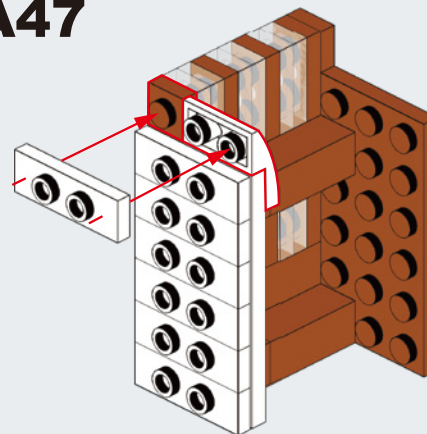

## A48

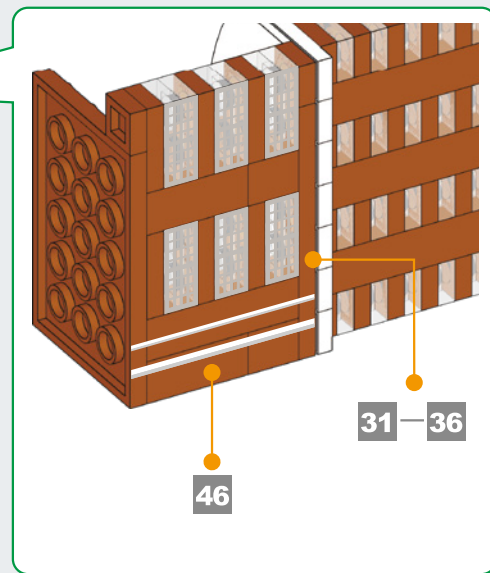
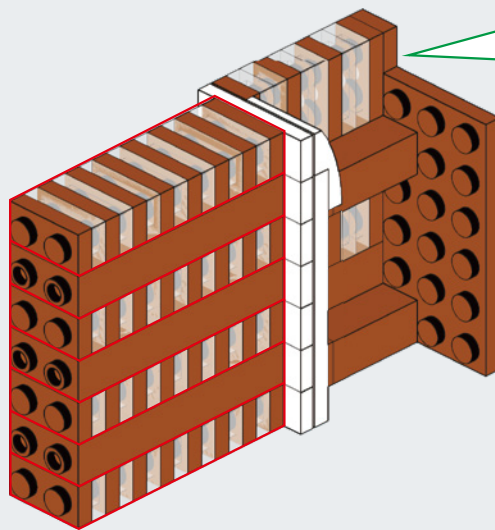
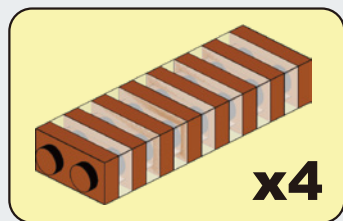

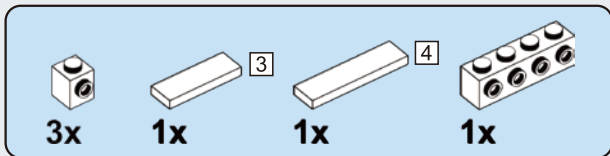

## A49

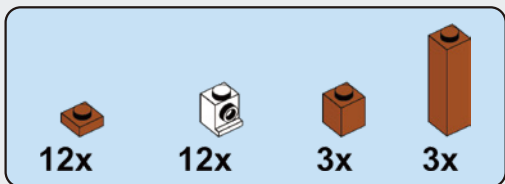
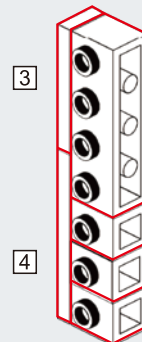

## A50

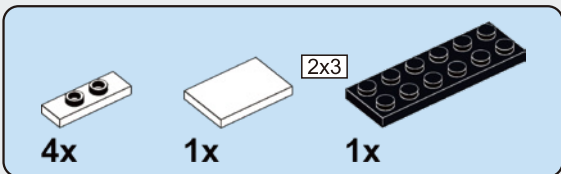
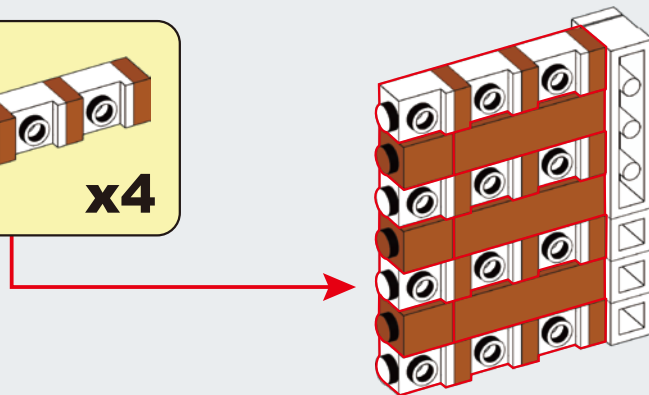
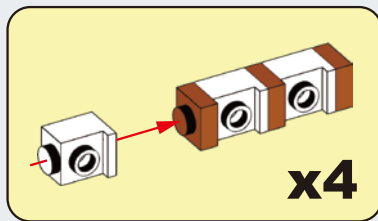

## A51

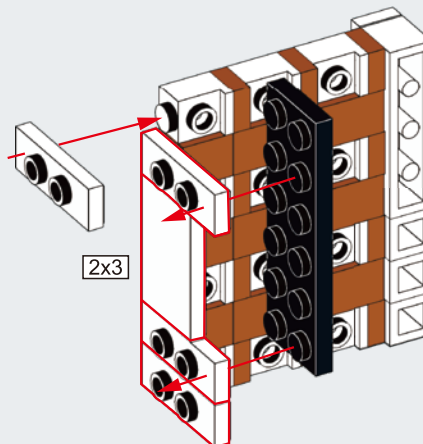

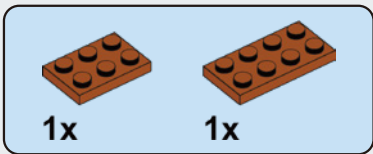

## A52

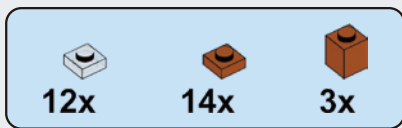
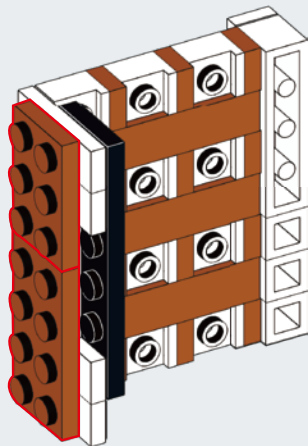

## A53

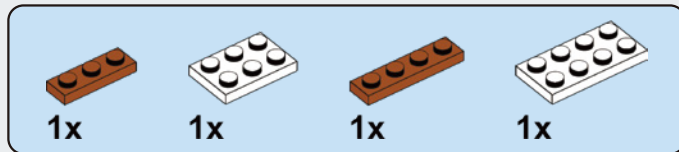
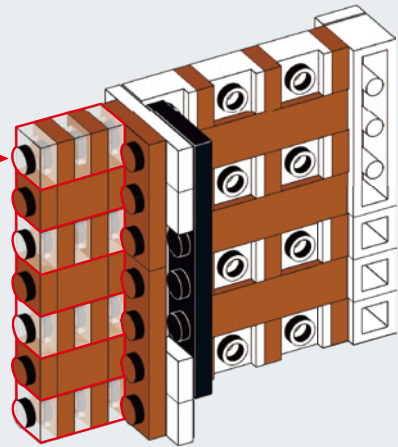
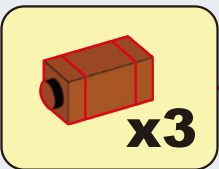

## A54

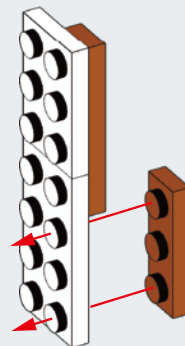

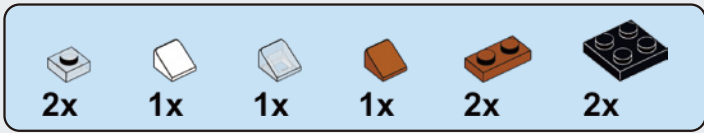

# A55

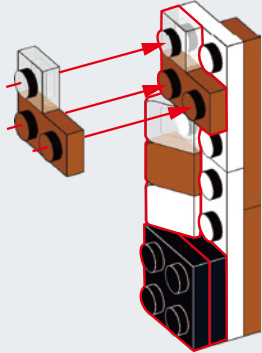

# A56

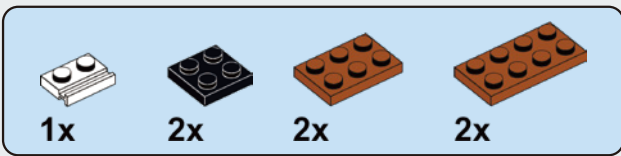
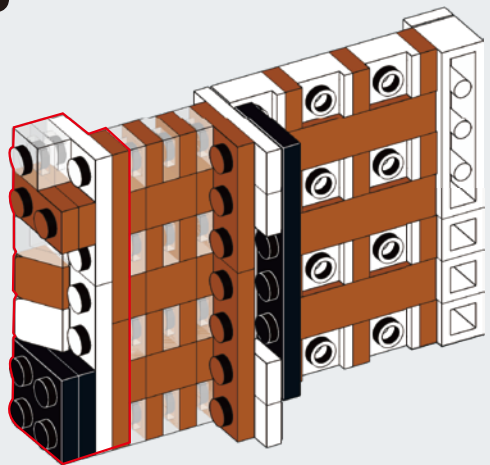

# A57

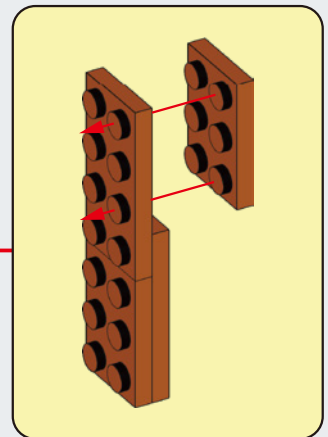
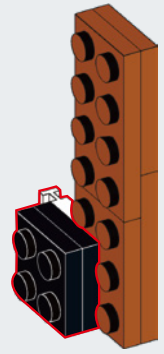
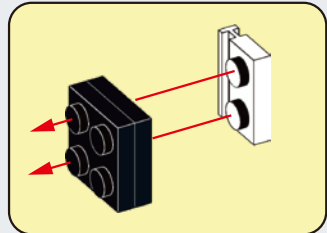

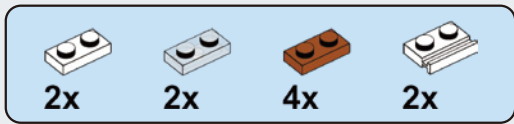

## A58

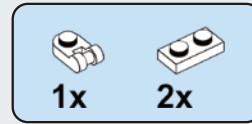
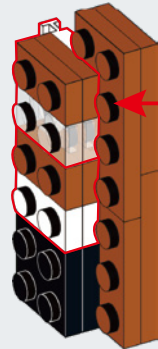
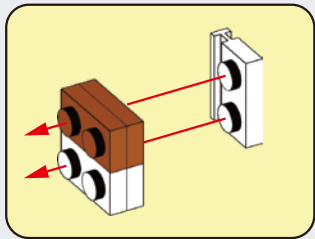
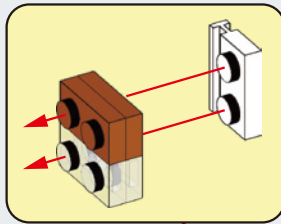

## A59

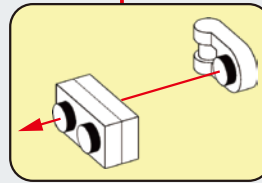
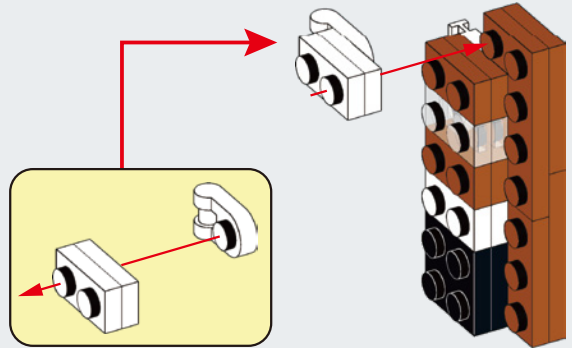

## A60

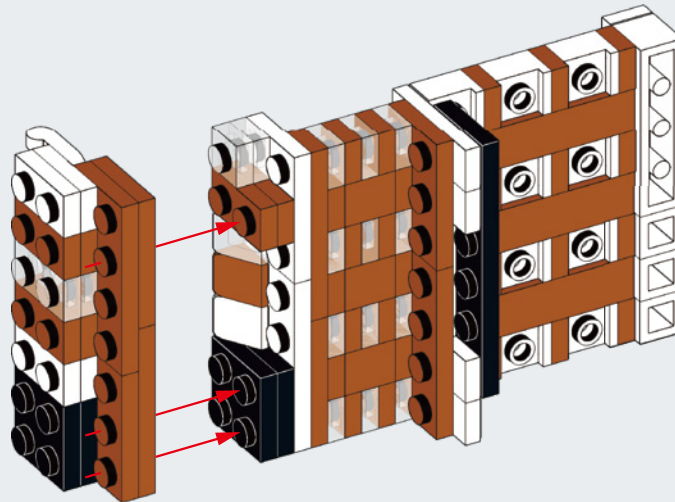

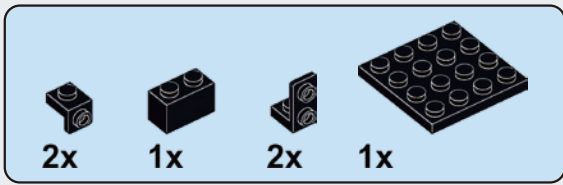

## A61

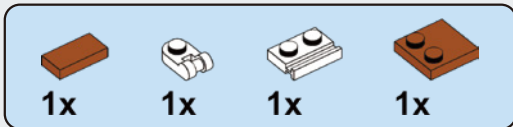
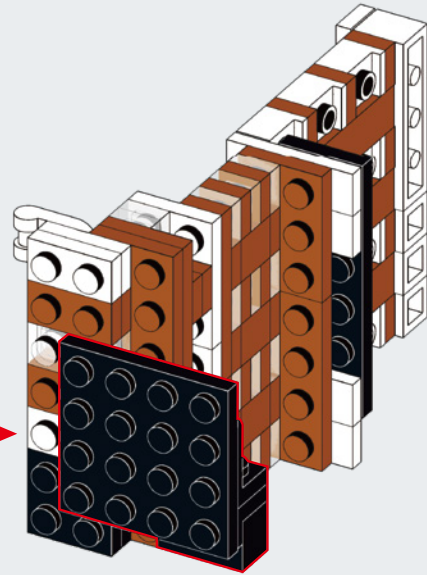
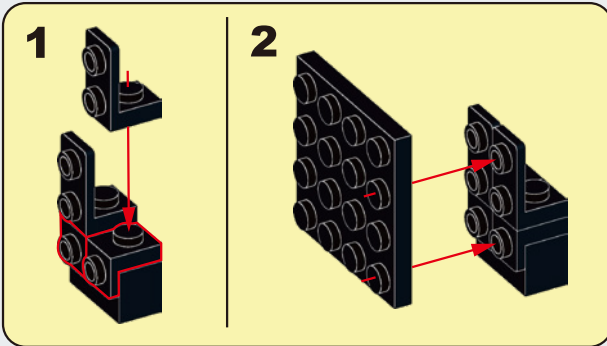

## A62

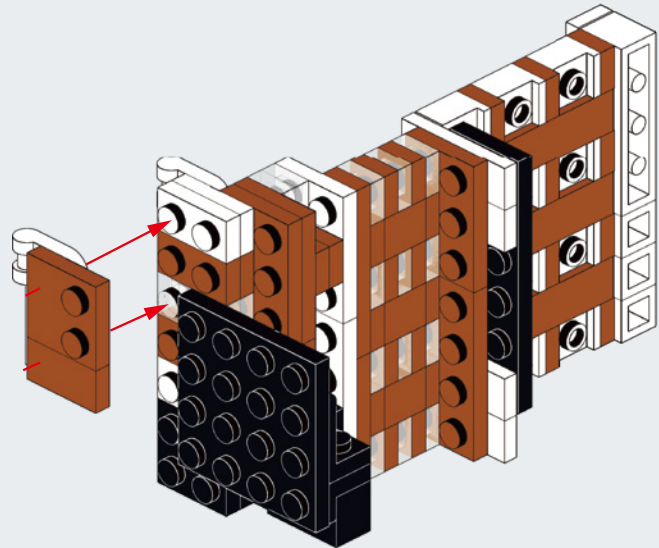
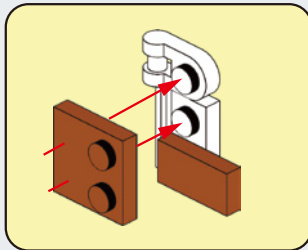



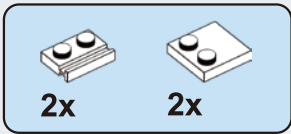

## A63

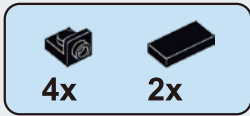
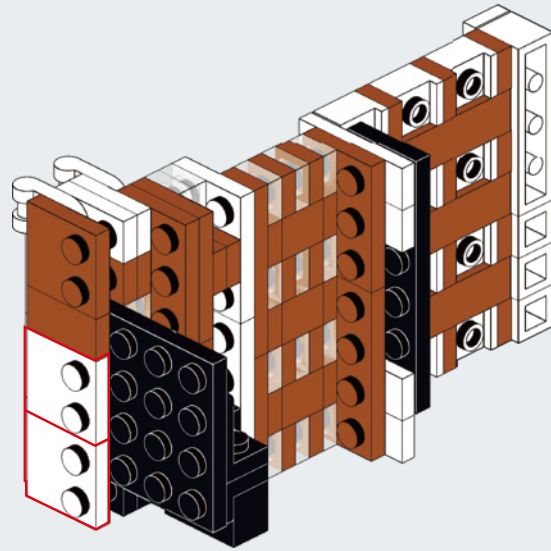
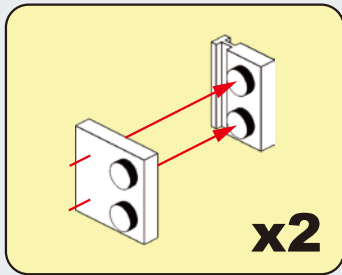

## A64

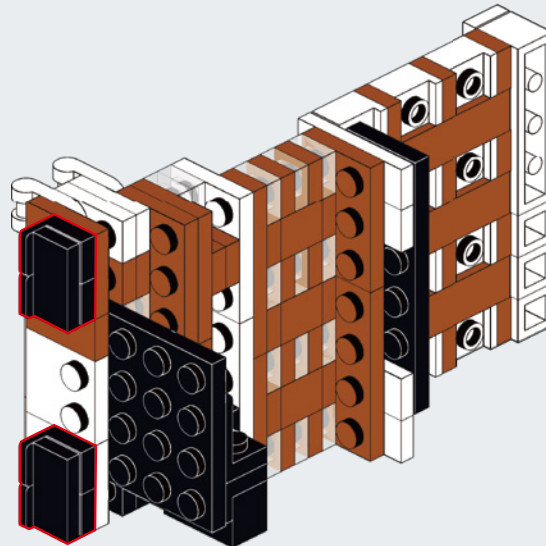
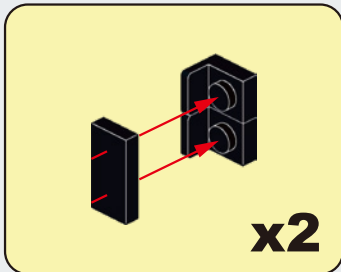

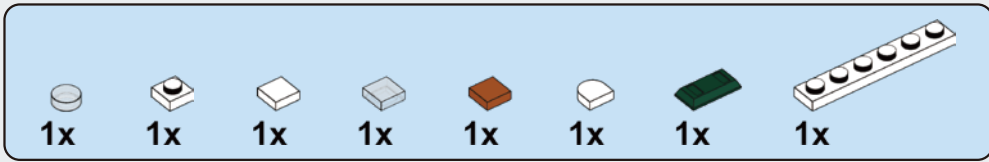

# A65

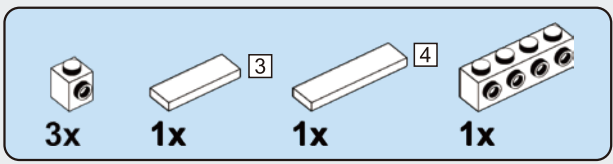
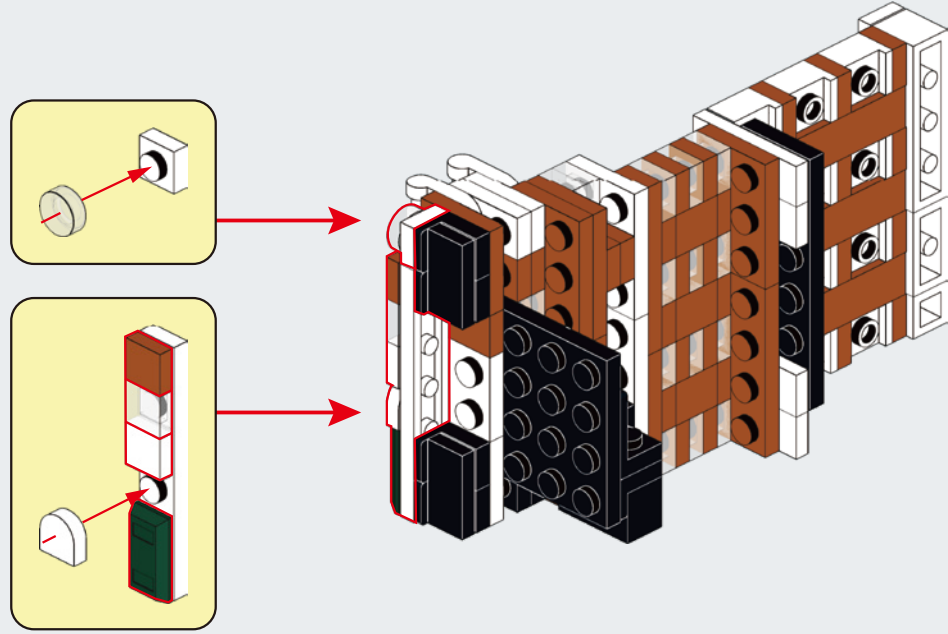

# A66

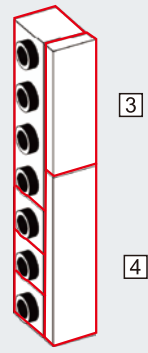

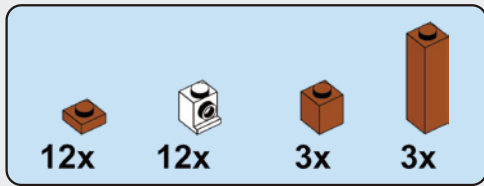

## A67

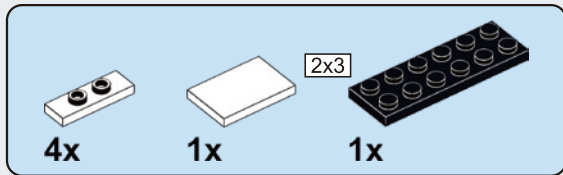
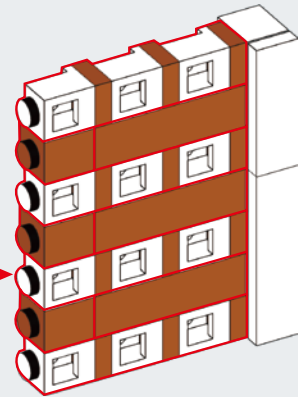
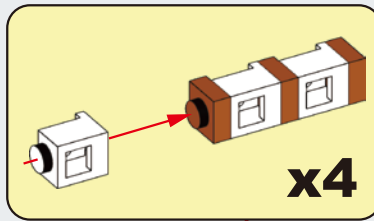

## A68

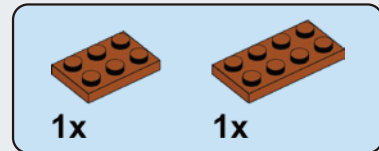
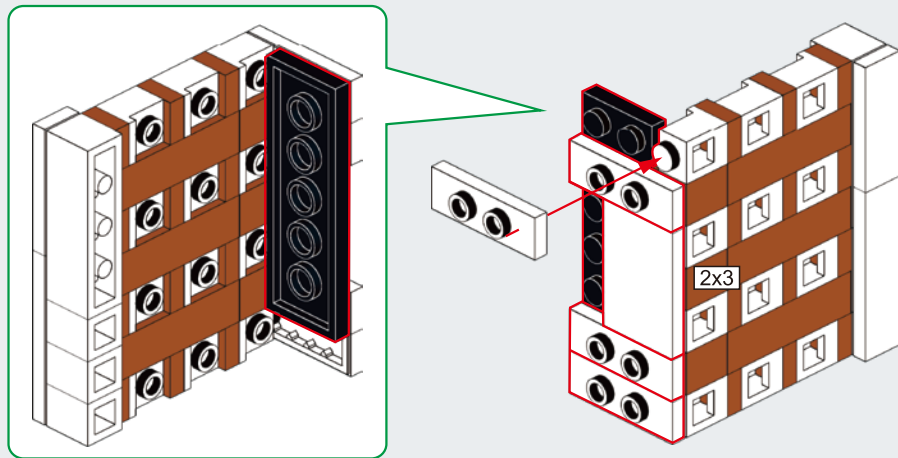

## A69

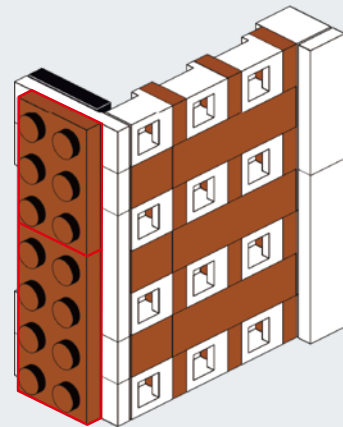

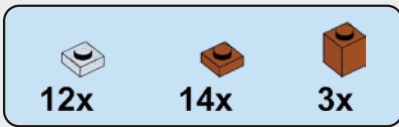

## A70

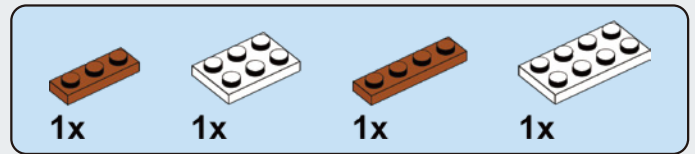
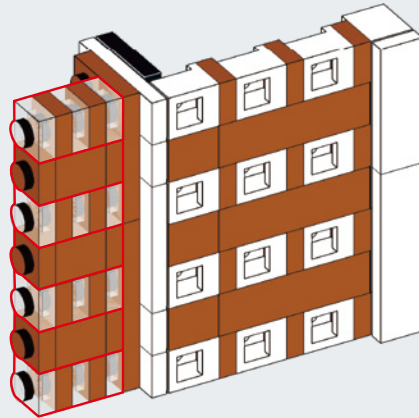
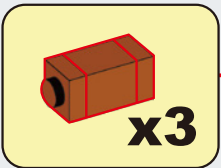
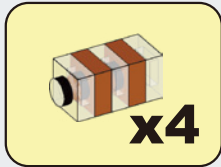

## A71

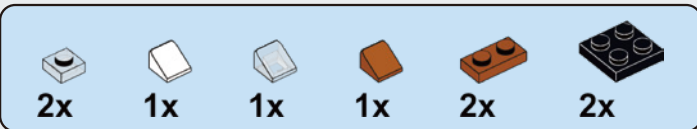
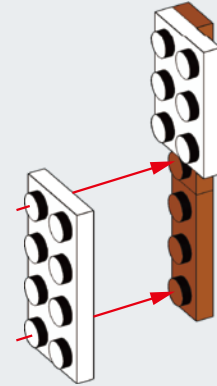

## A72

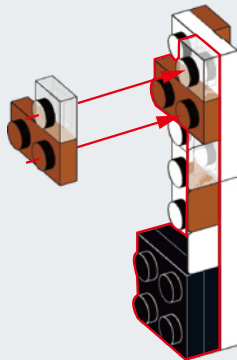

## A73

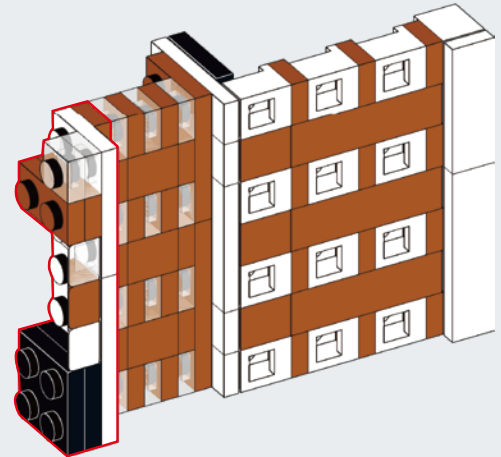

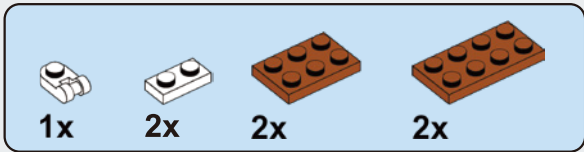

## A74

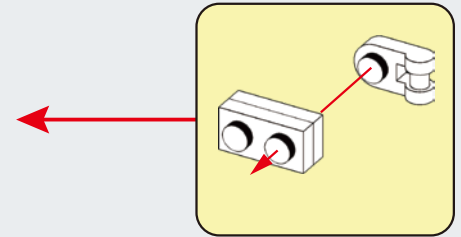
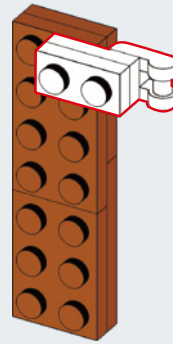
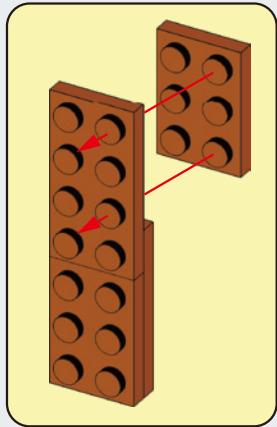

## A75

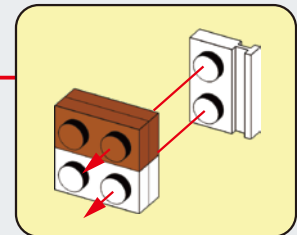
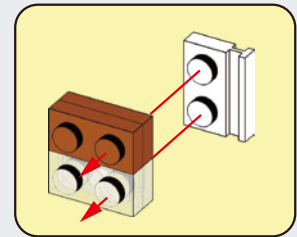
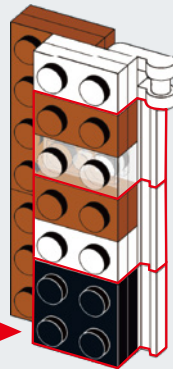
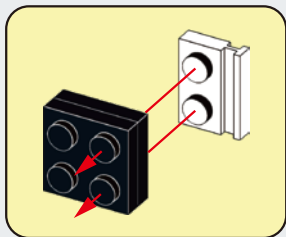

# A76

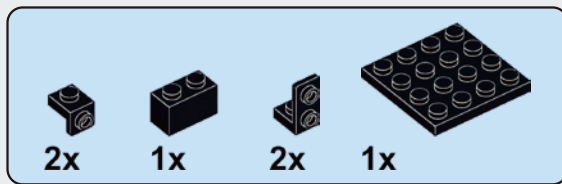
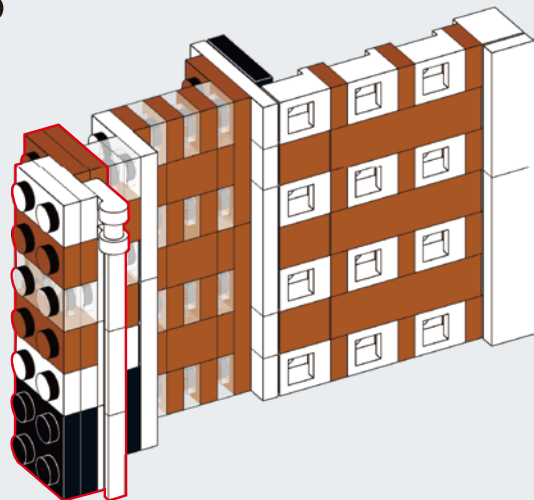

# A77

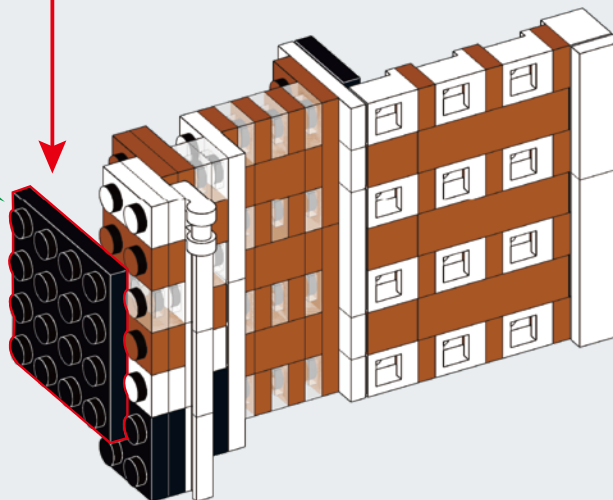
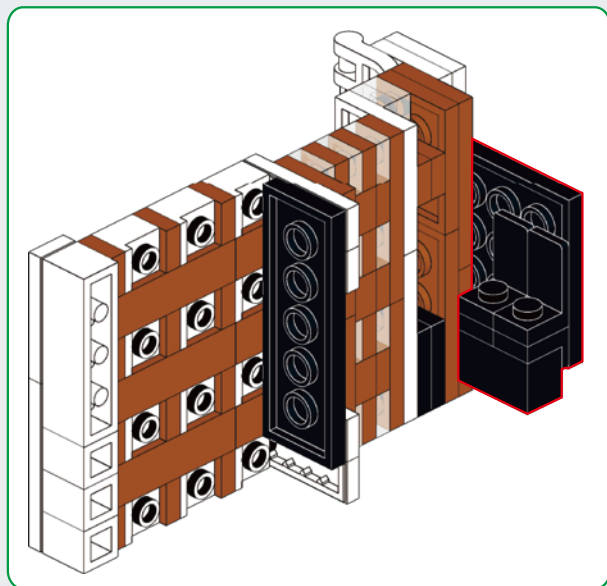
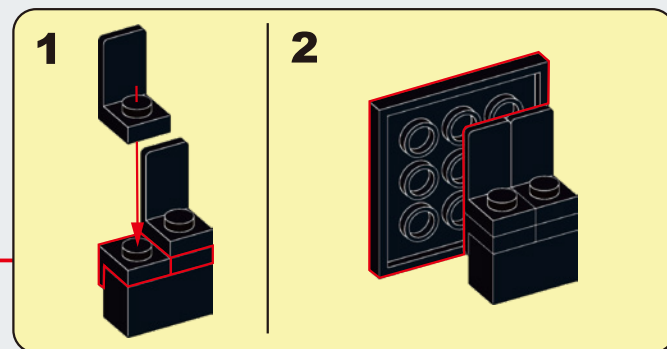

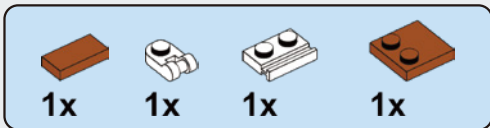

**A78**

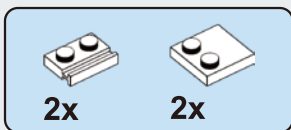
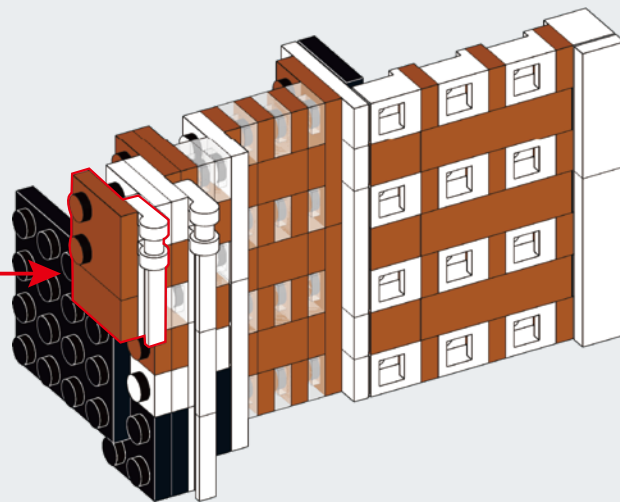
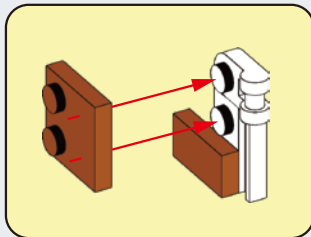

**A79**

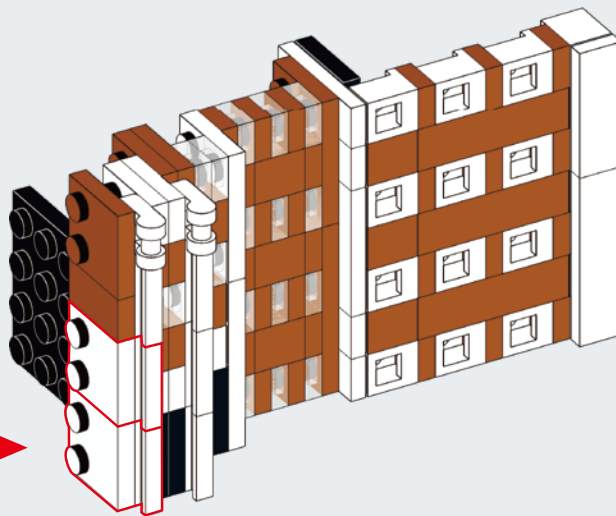
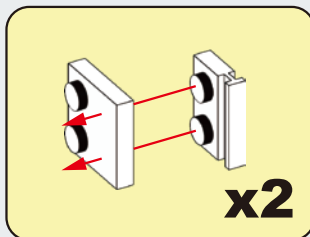

**B**

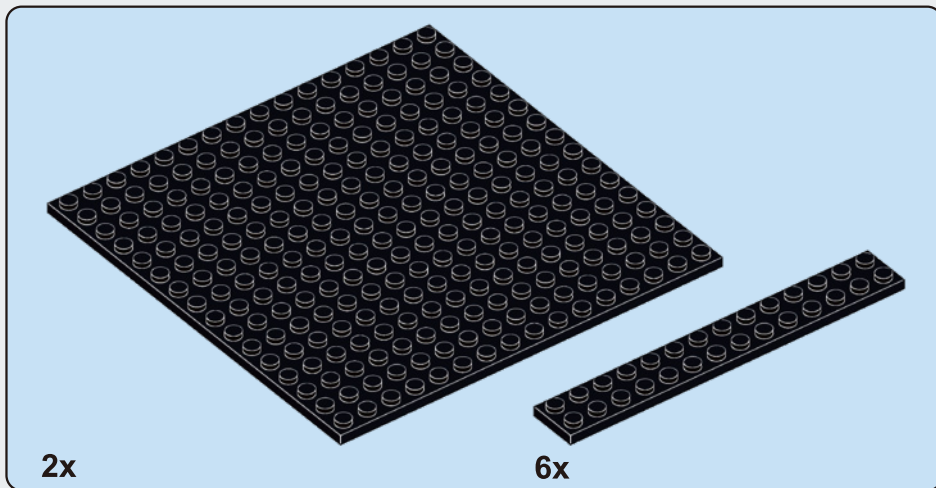
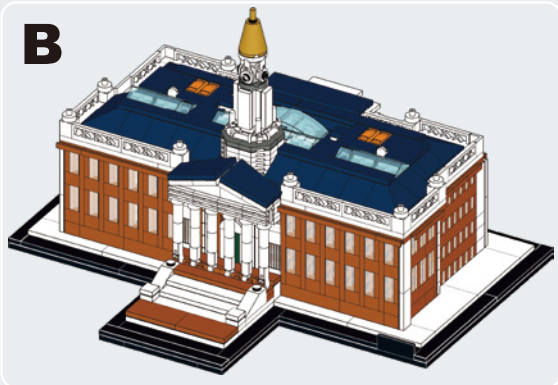

**B1**

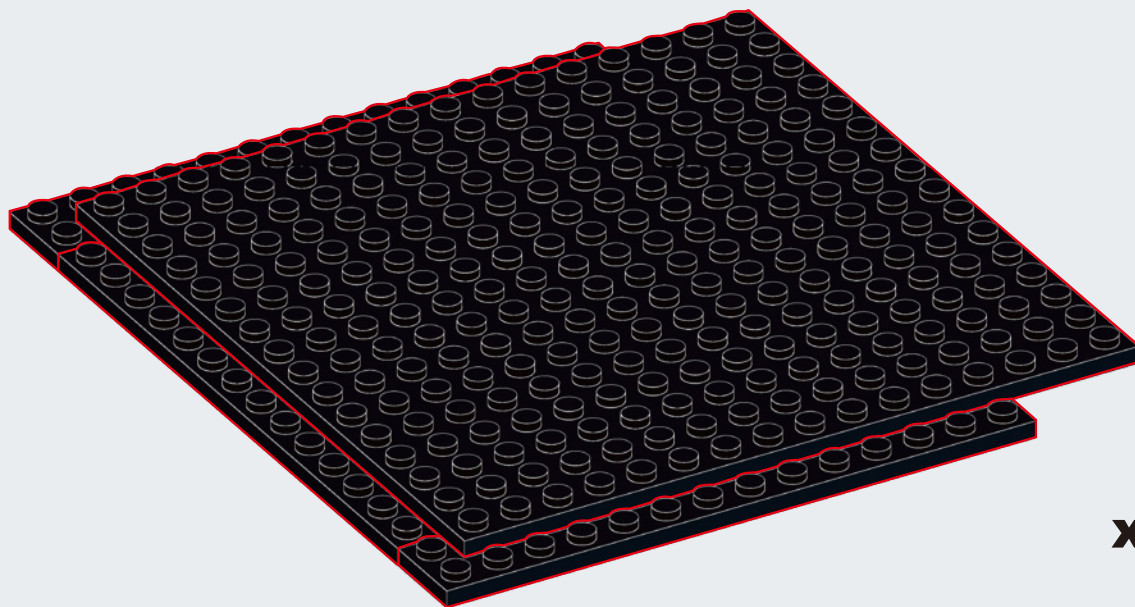

**x2**



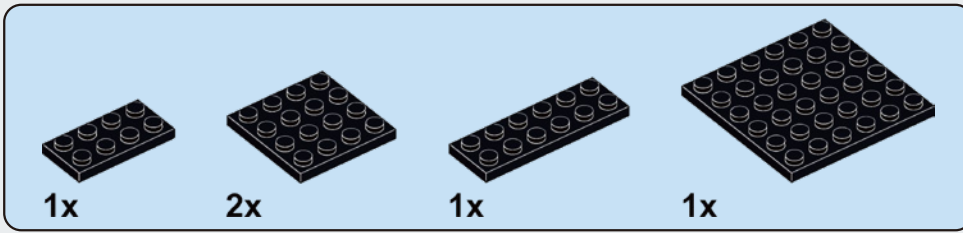

**B2**

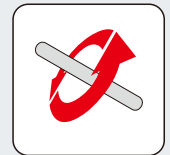
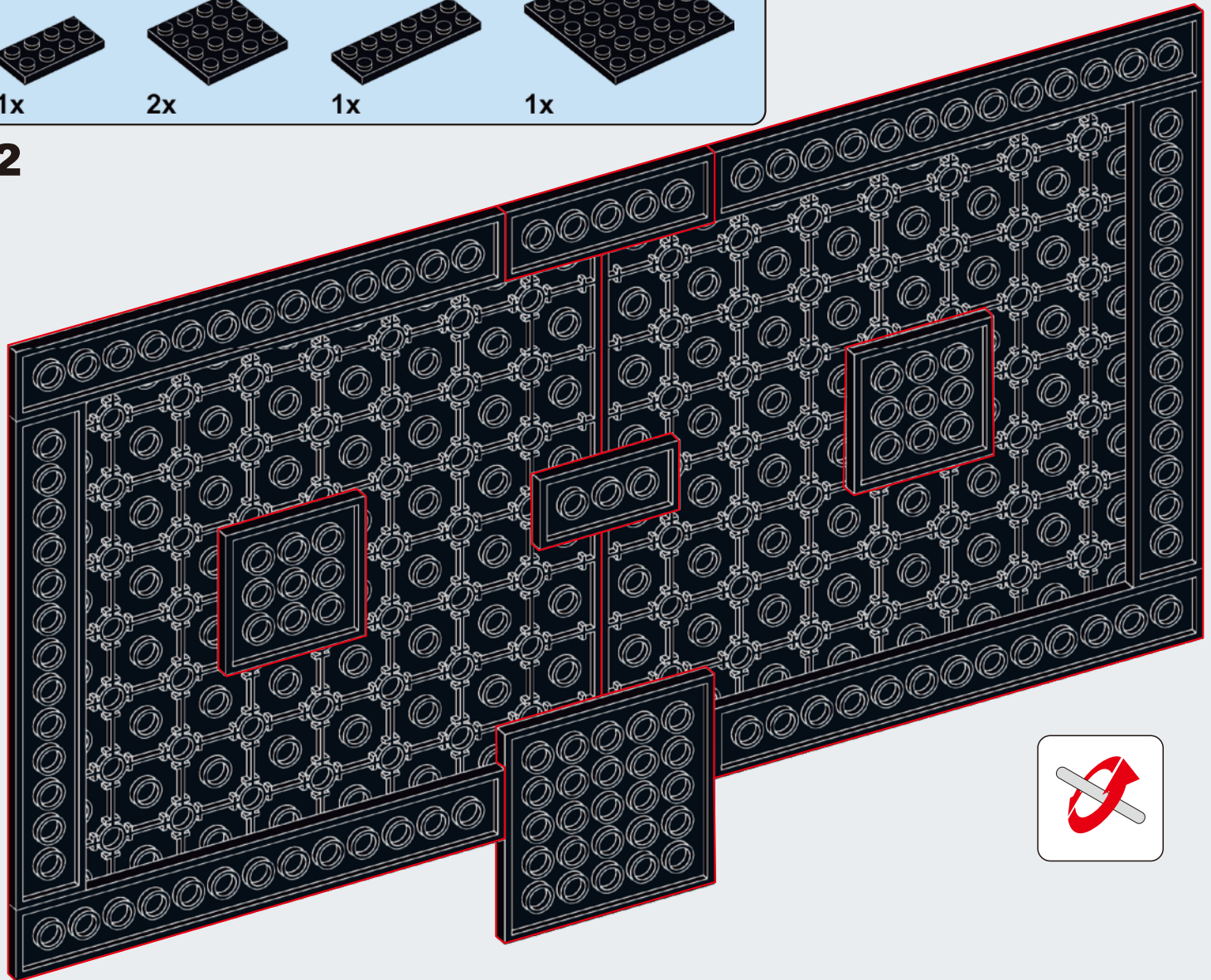

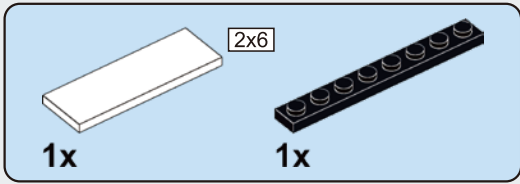

**B3**

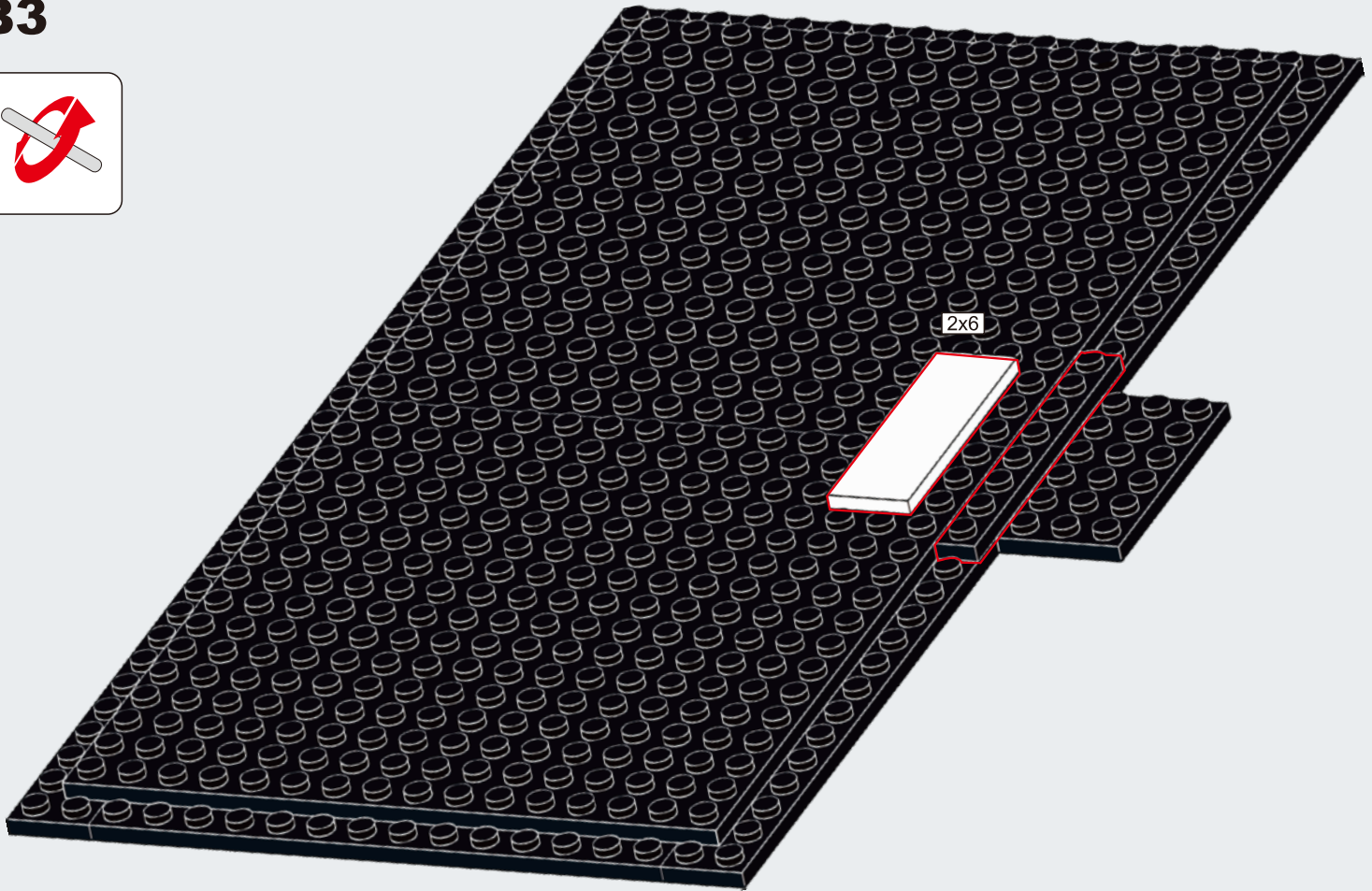

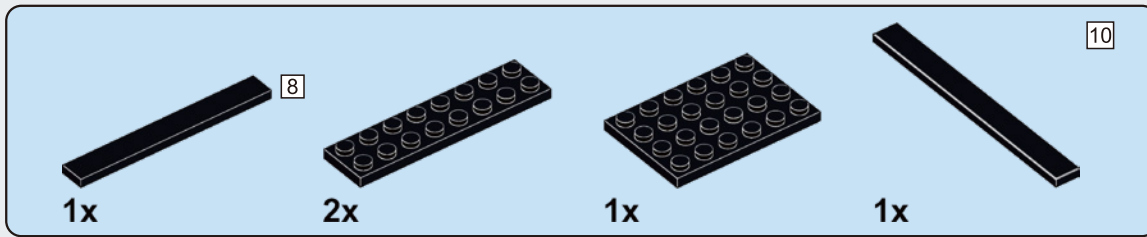

## B4

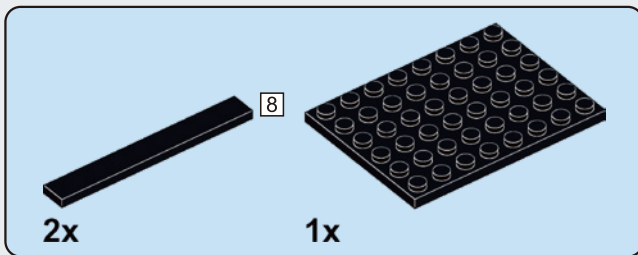
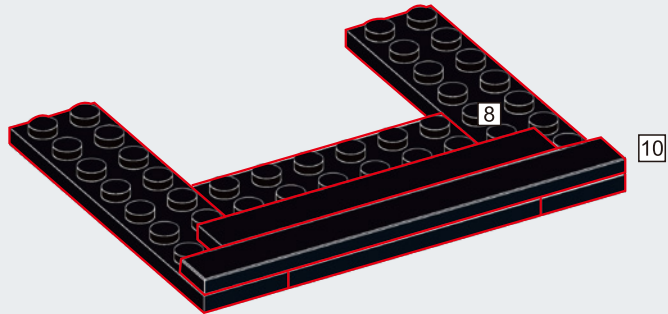

## B5

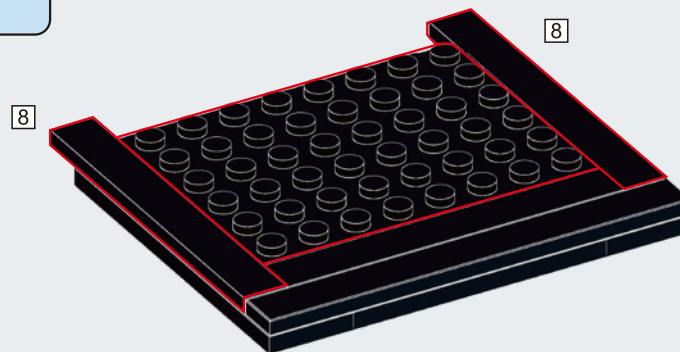

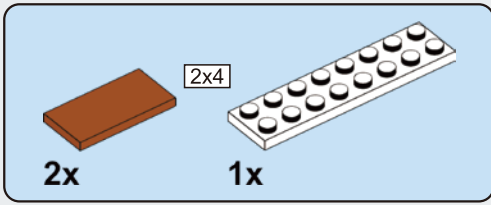

**B6**

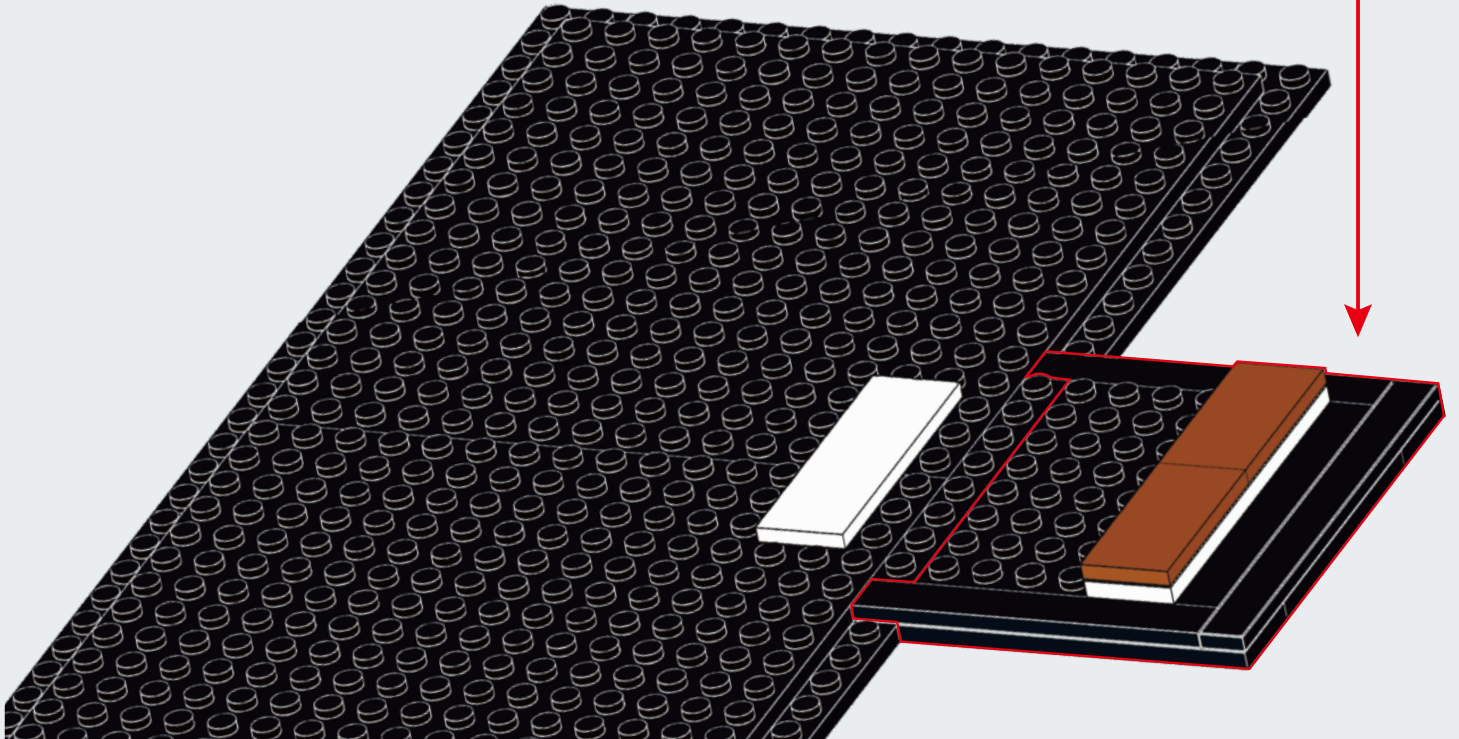
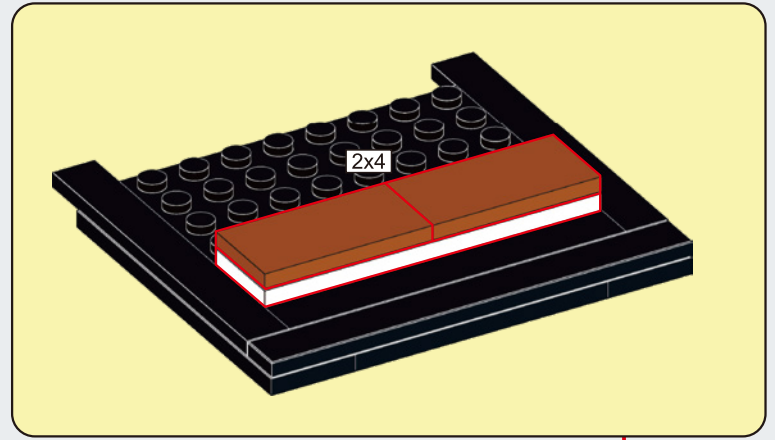

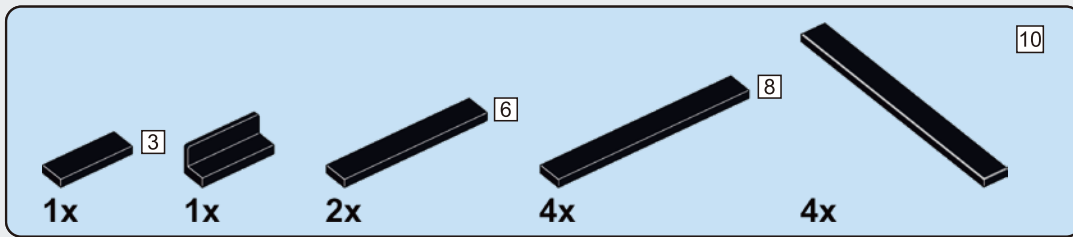

# B7

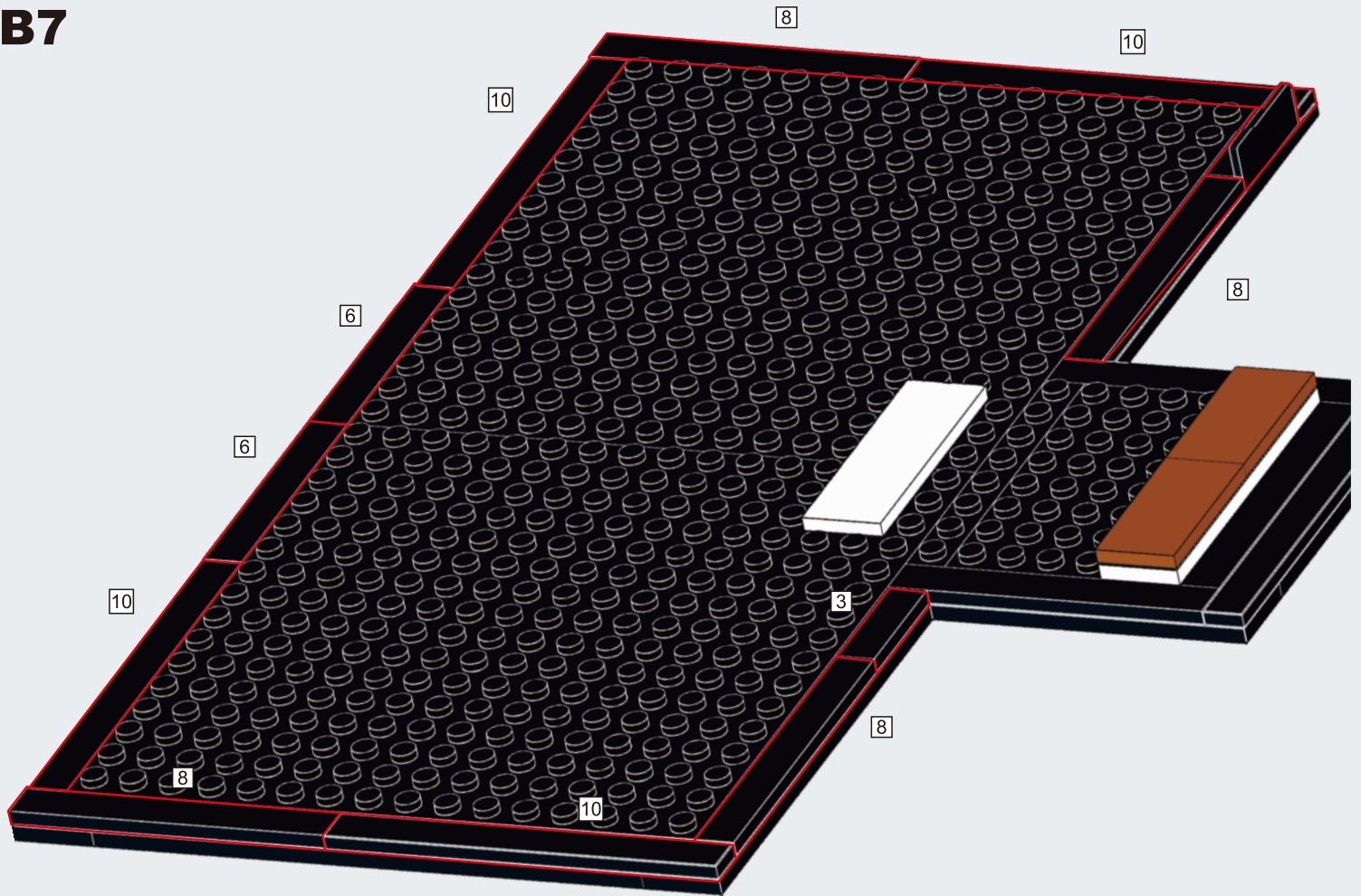

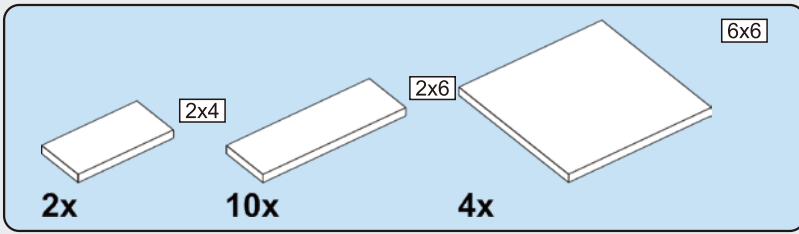

**B8**

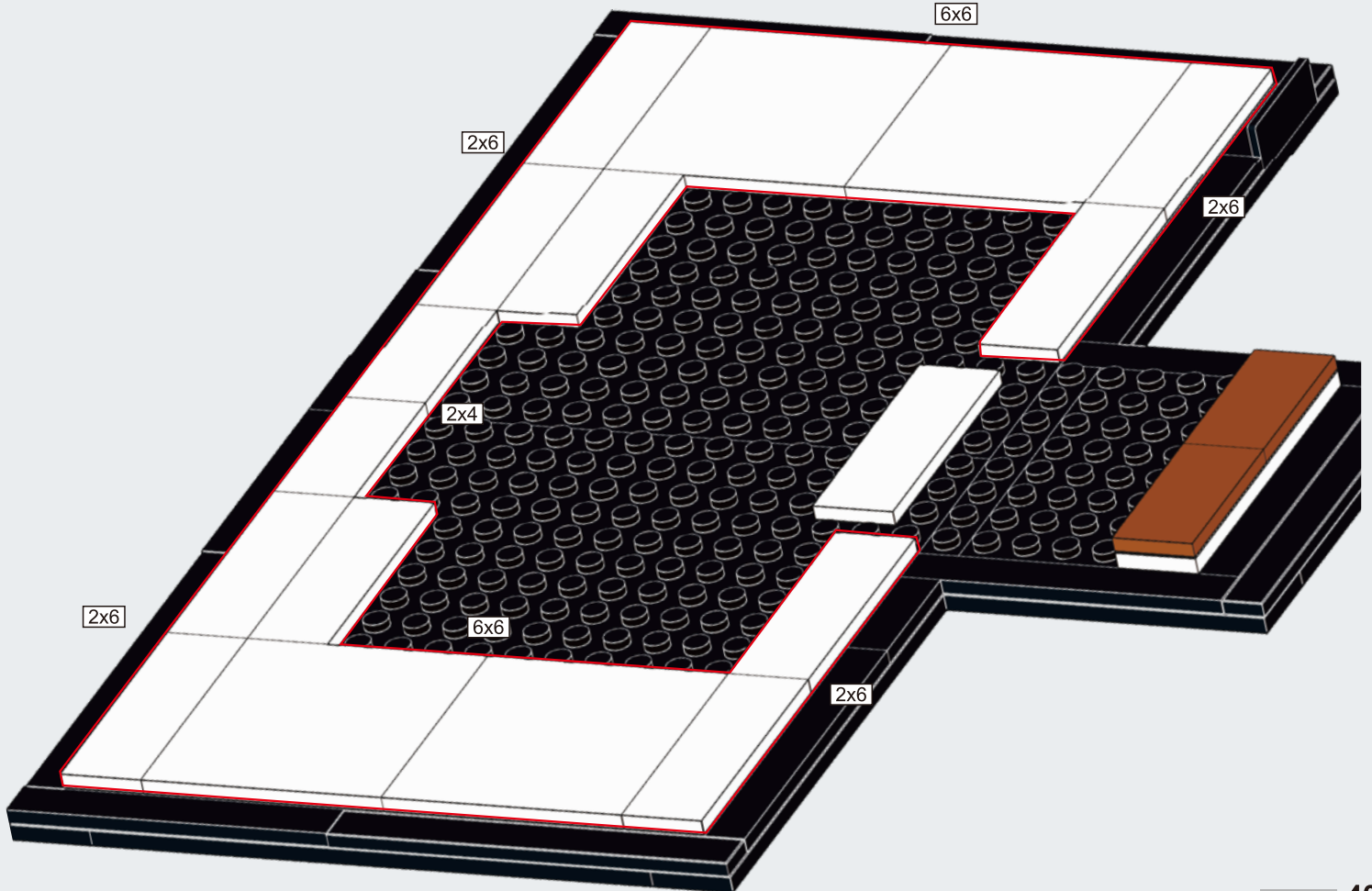

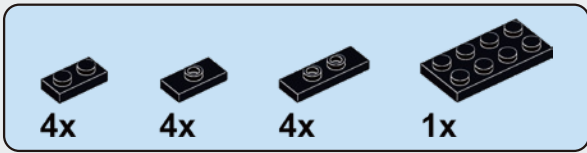

# B9

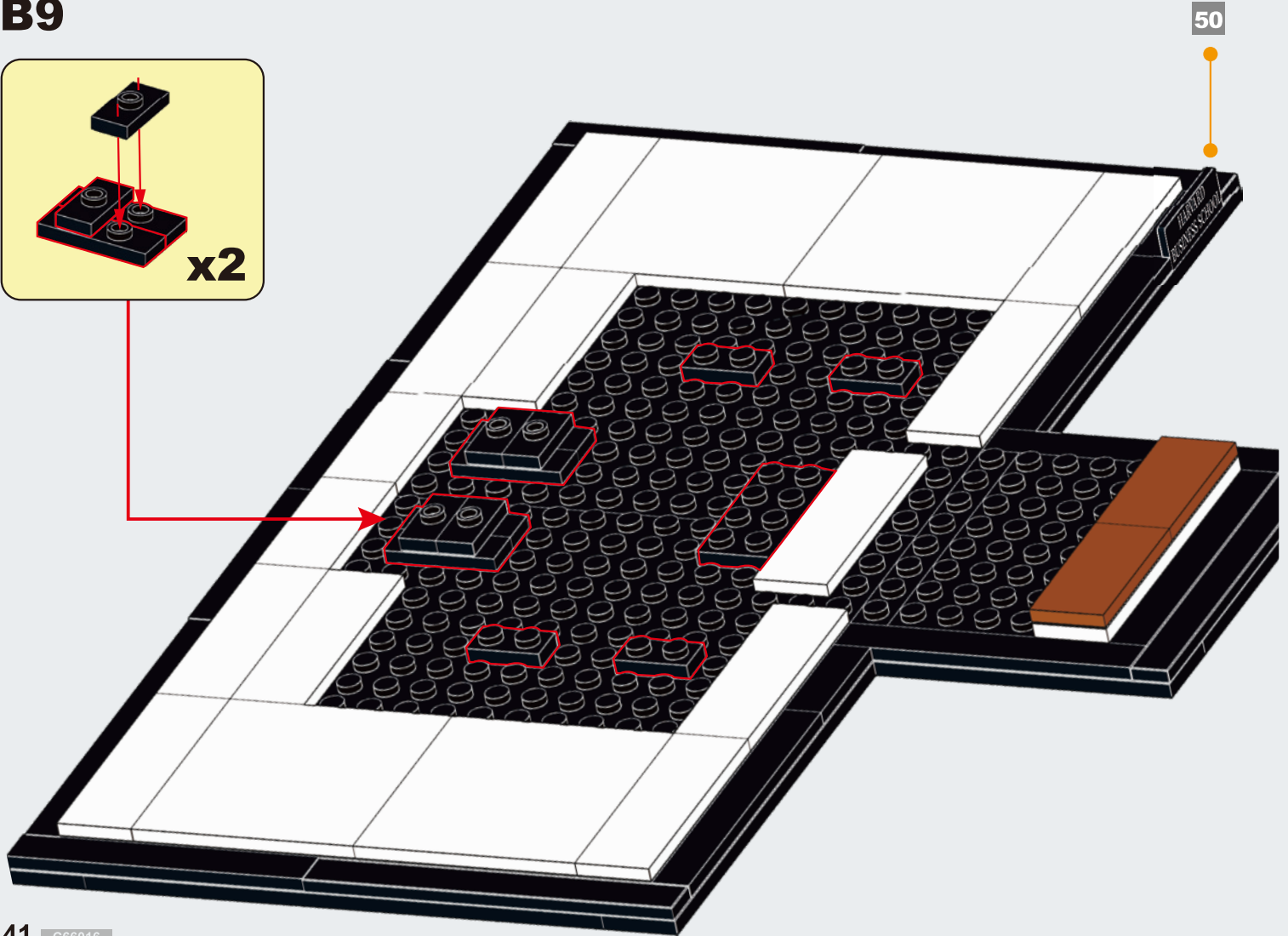
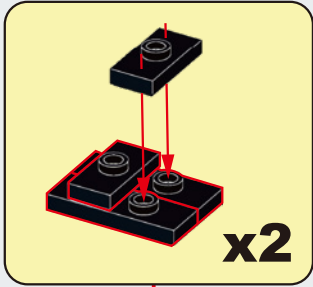

# B10

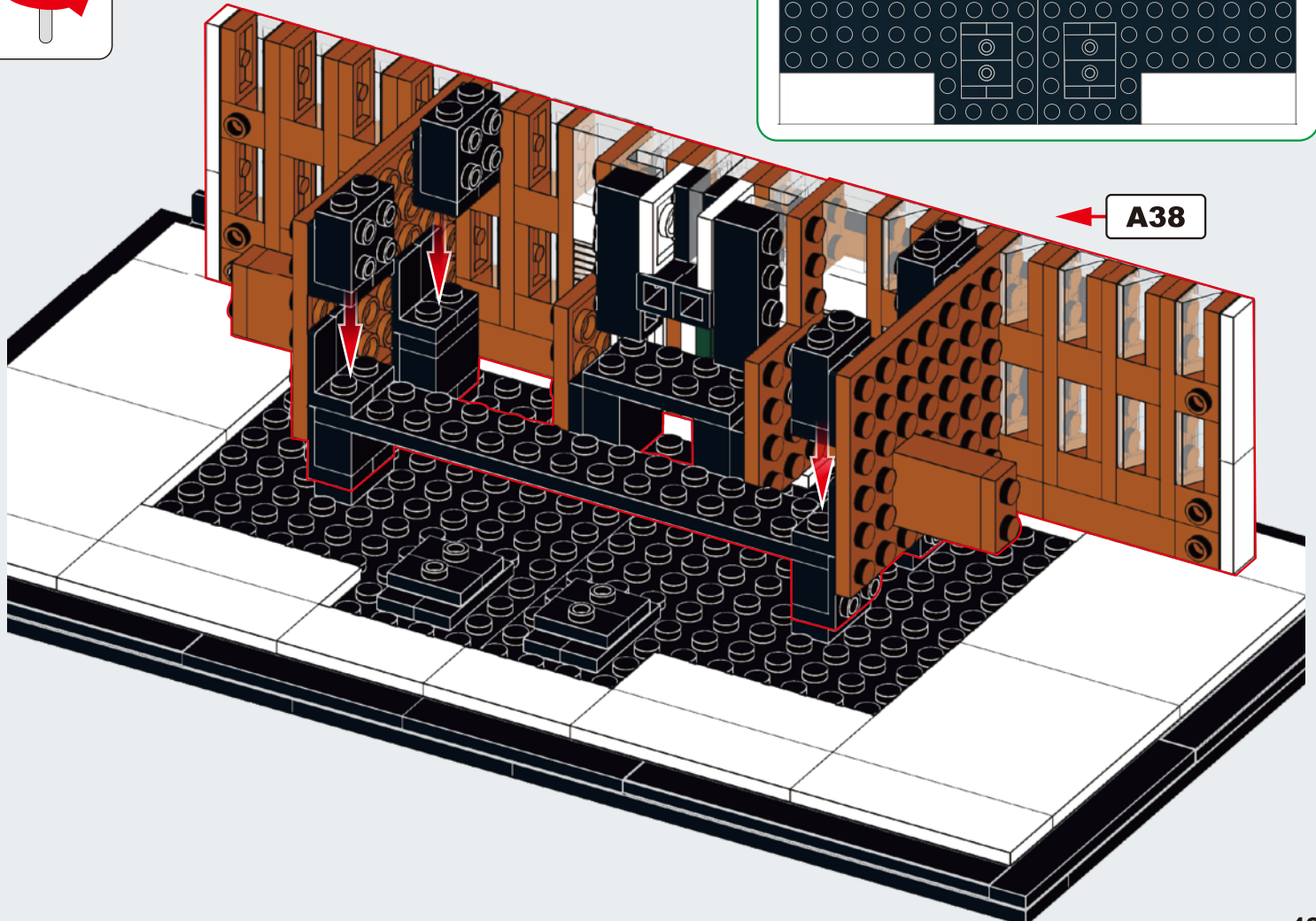
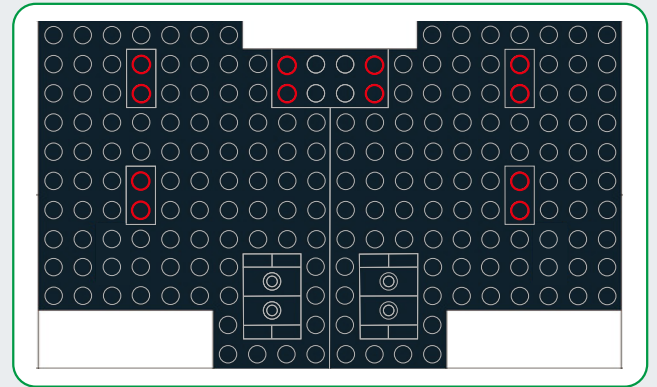



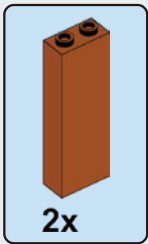

**B11**

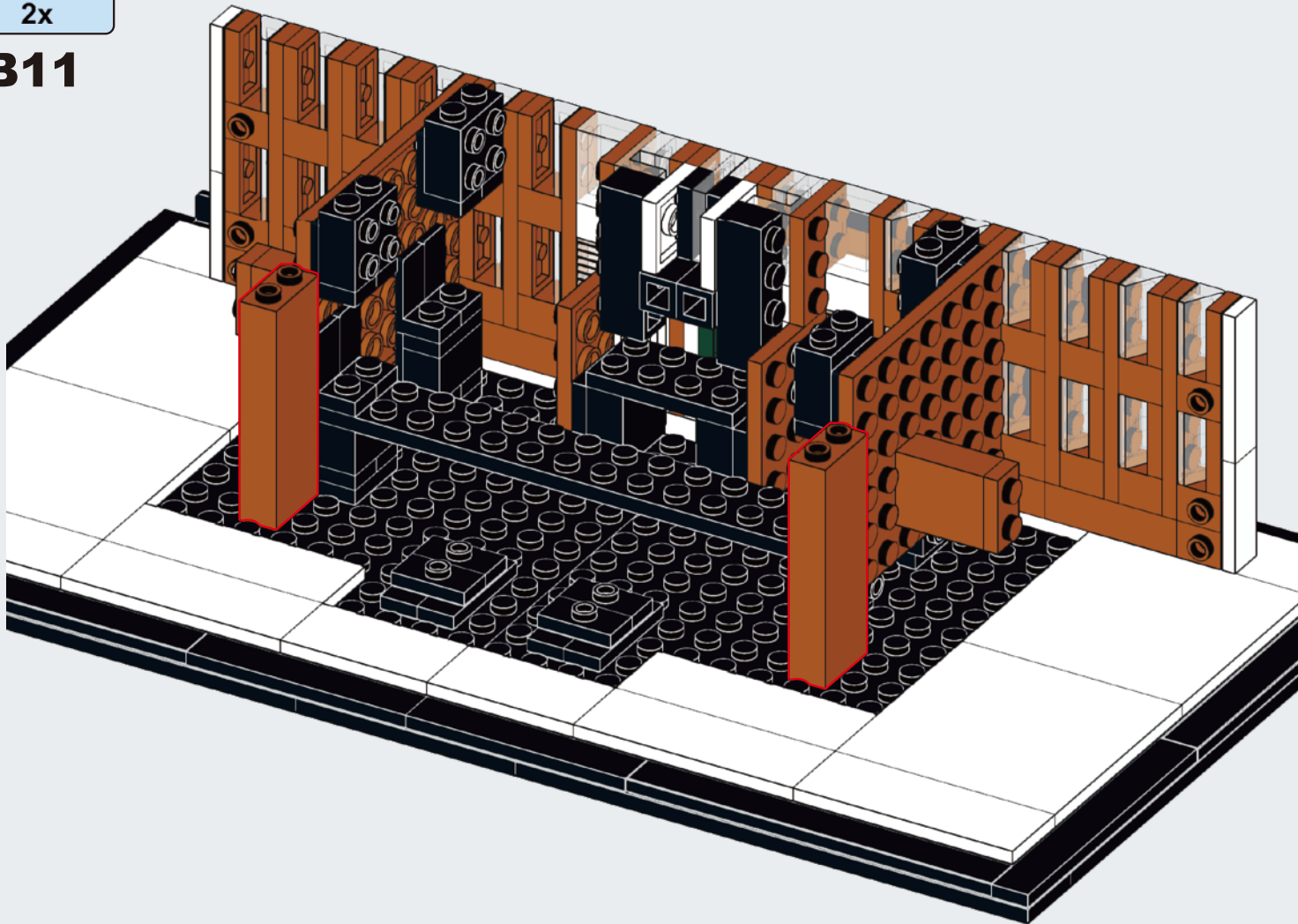

**B12**

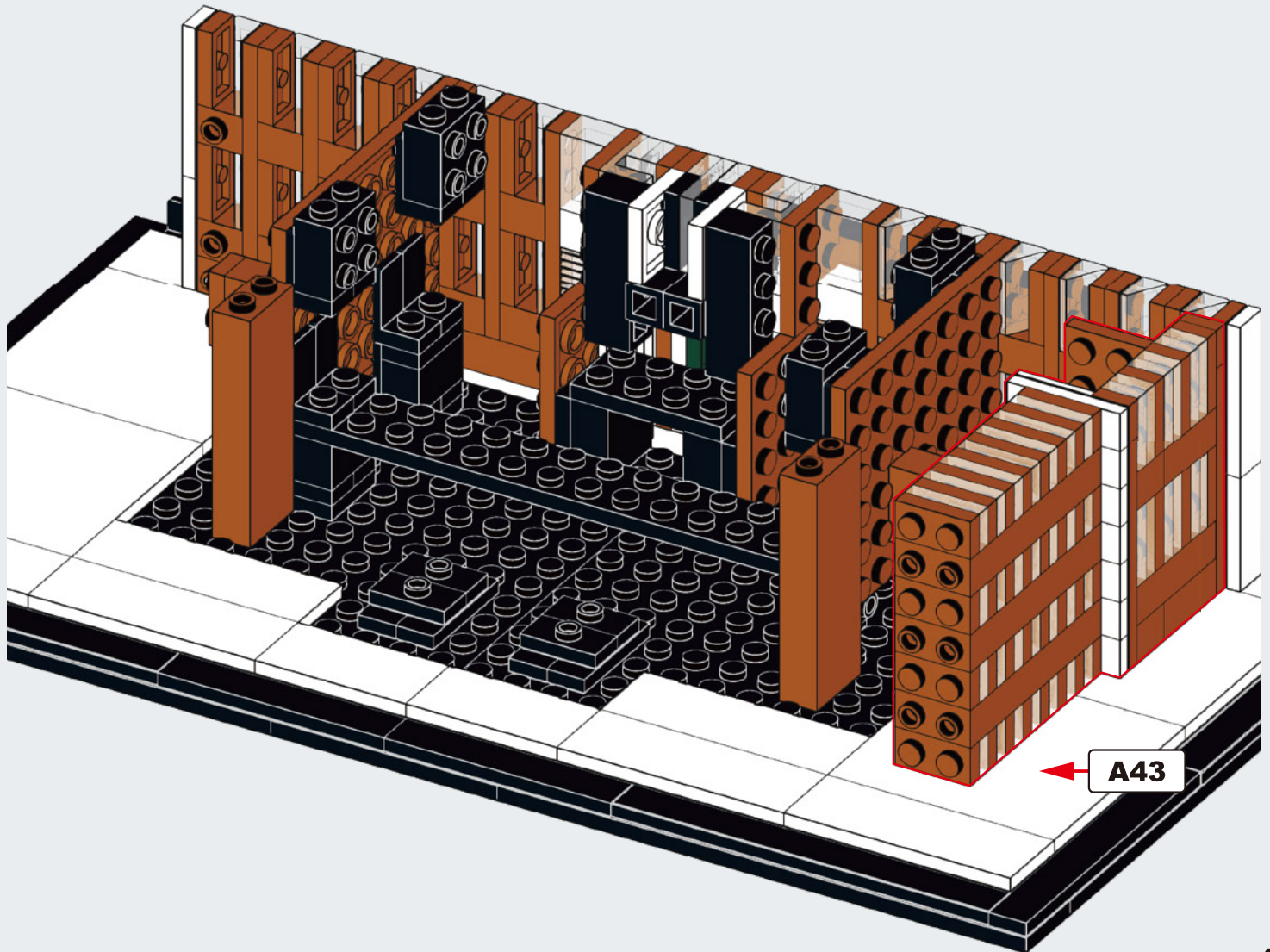

# B13

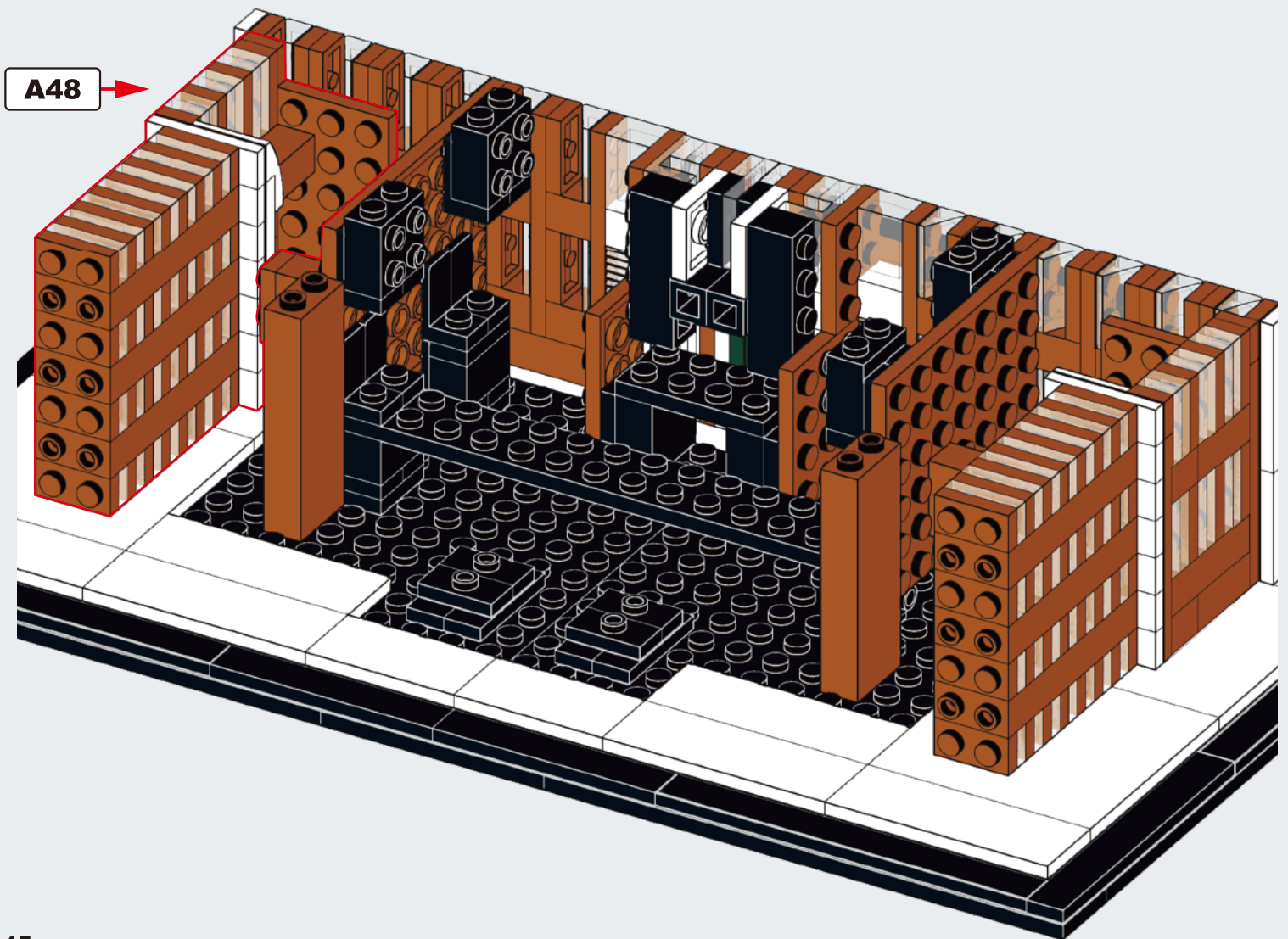

# B14

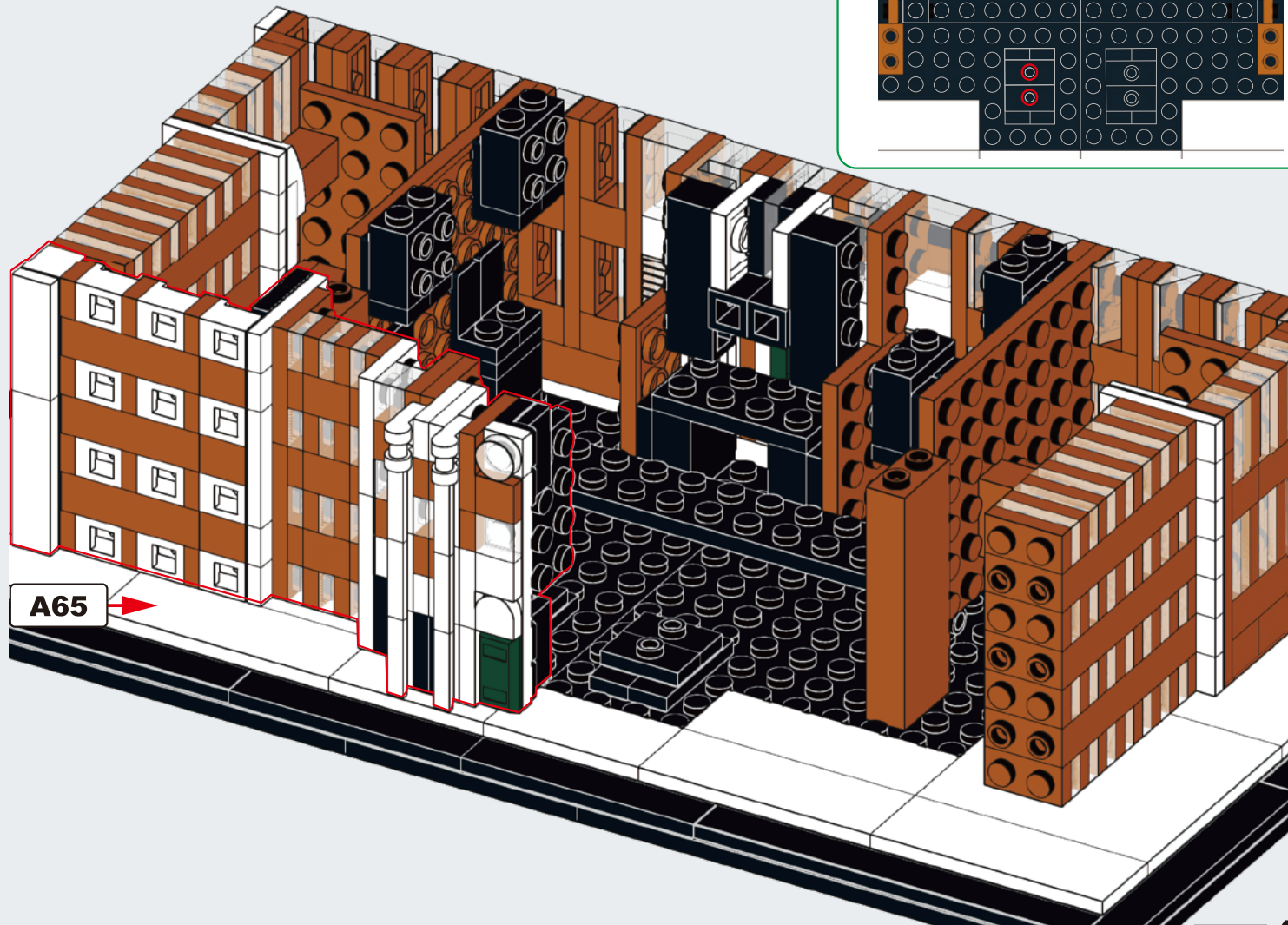

# B15

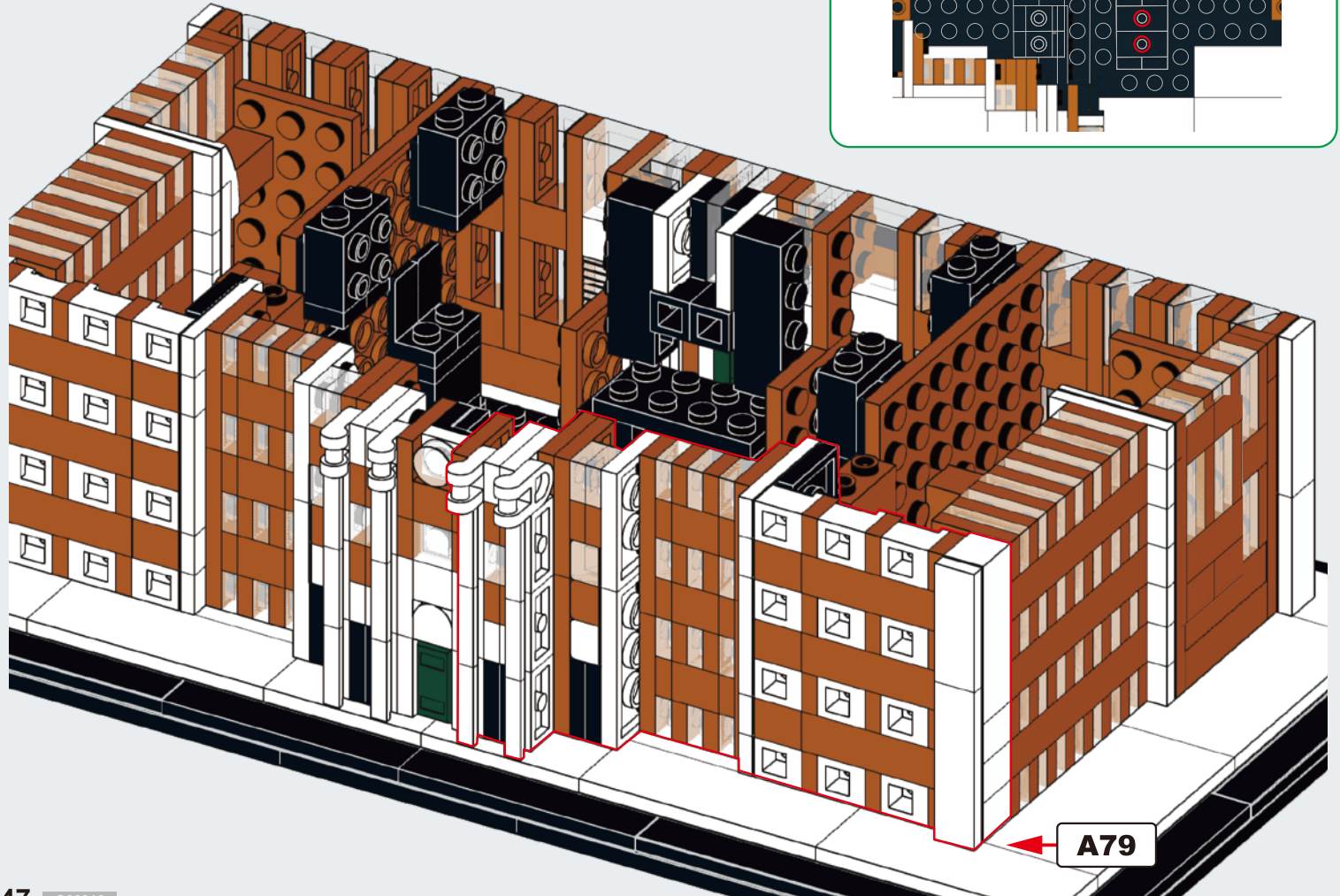
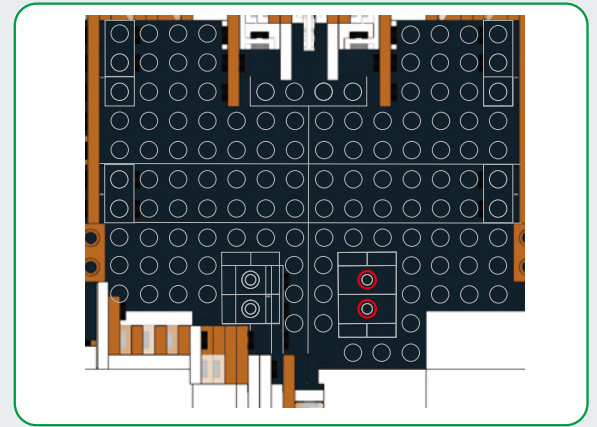

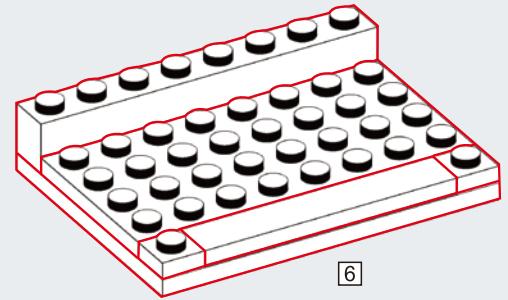
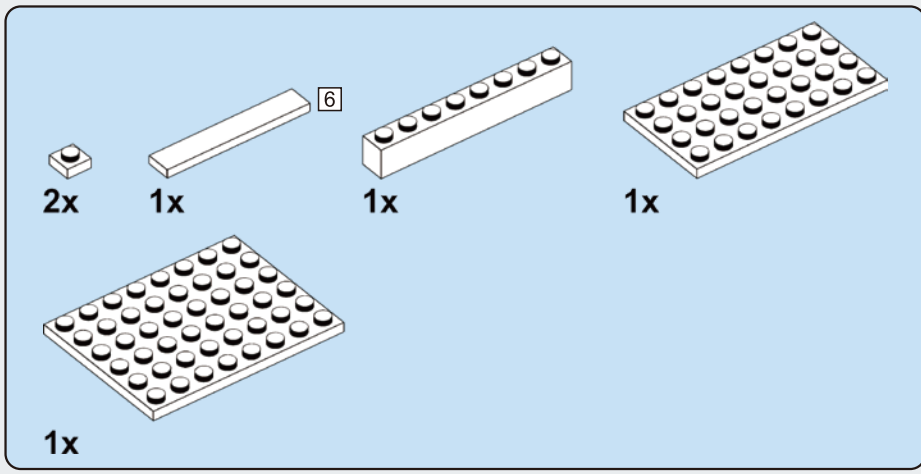

## B16

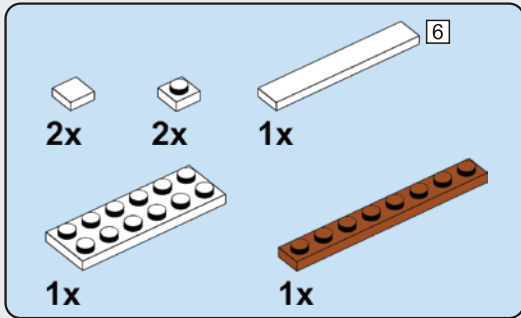

## B17

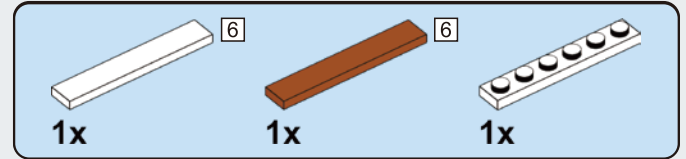
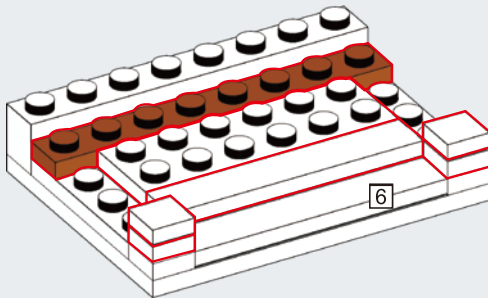

## B18

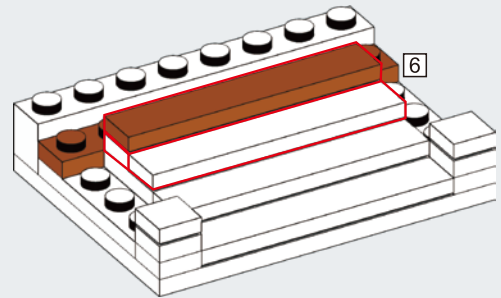

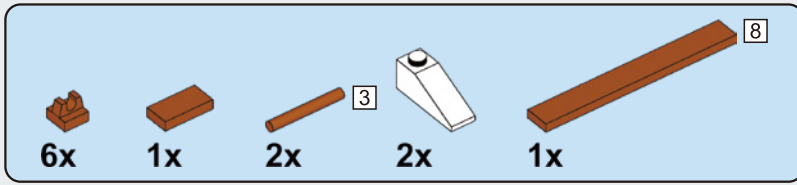

## B19

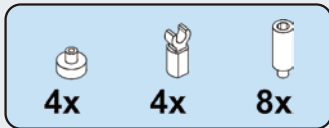
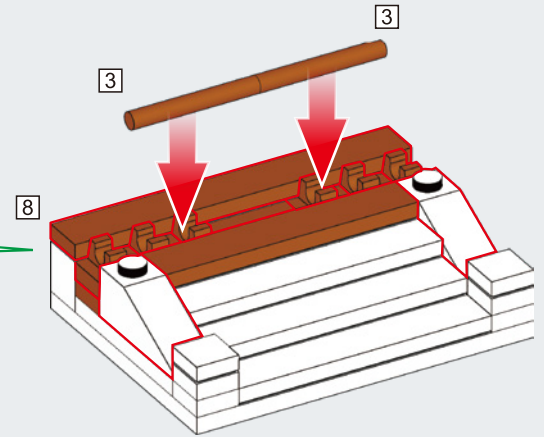
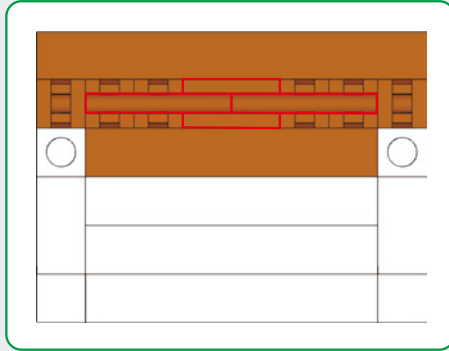

## B20

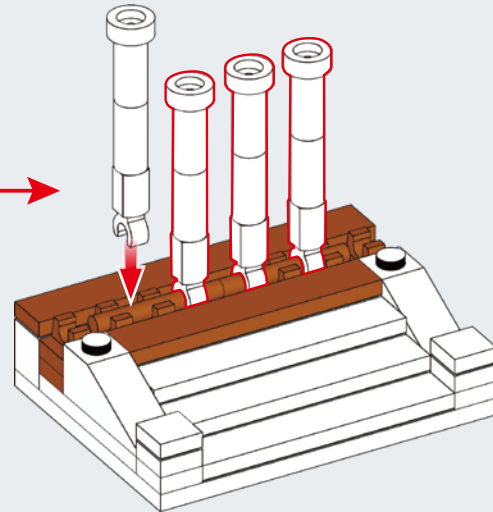
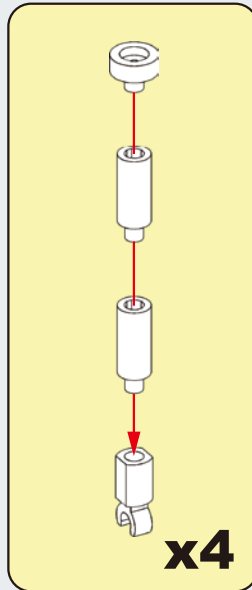

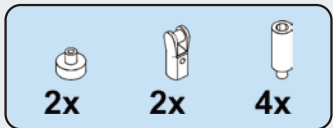

**B21**

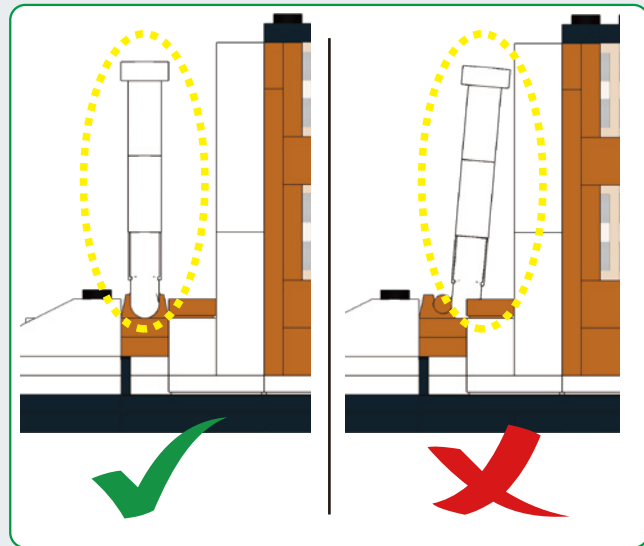
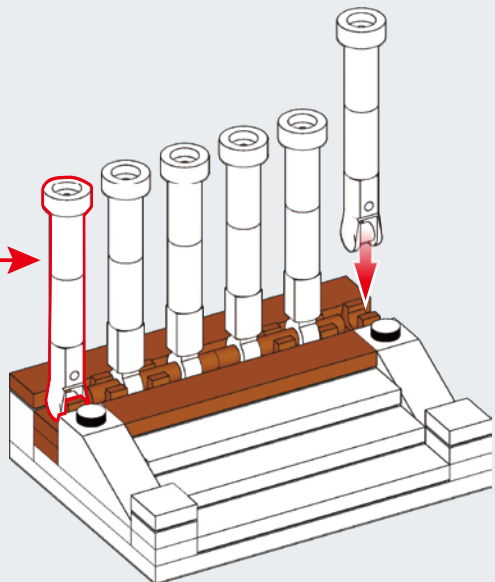
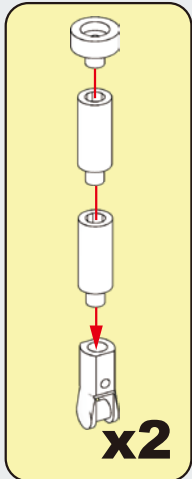

**B22**

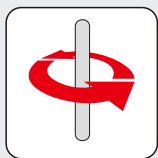

**B15**

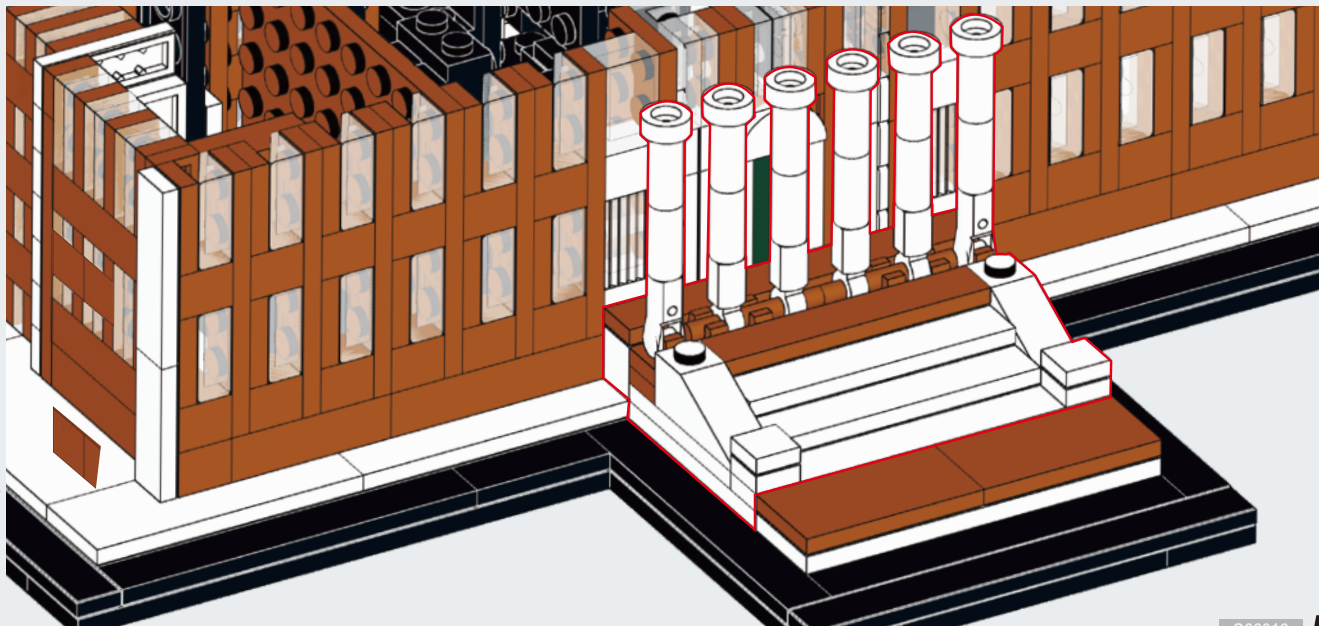



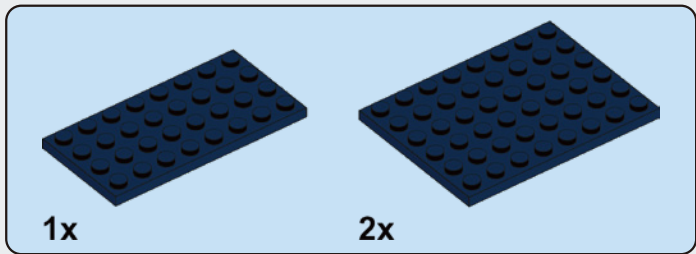

## B23

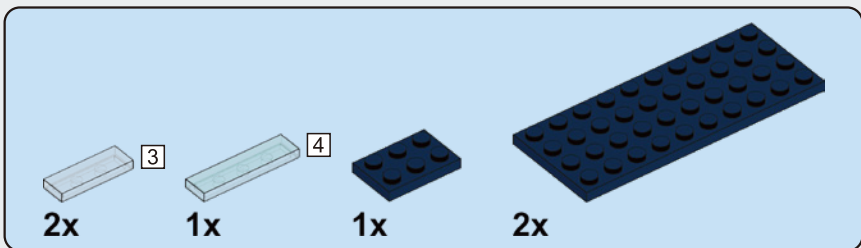
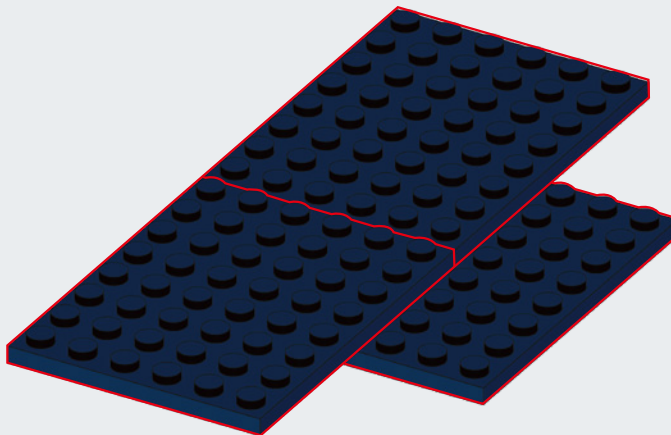

## B24

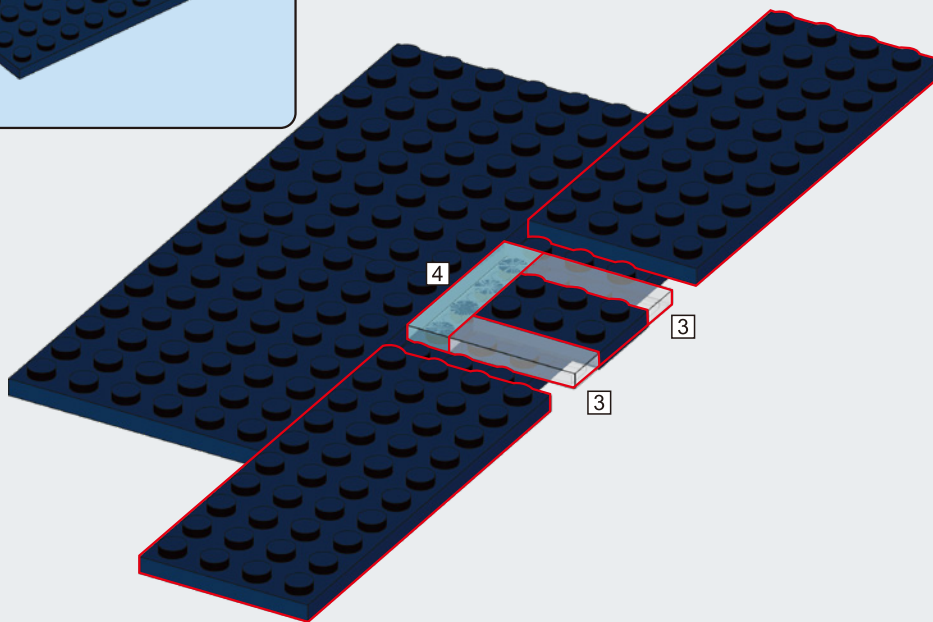

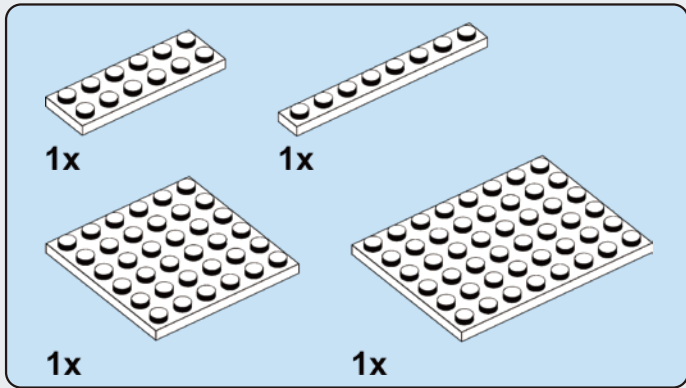

**B25**

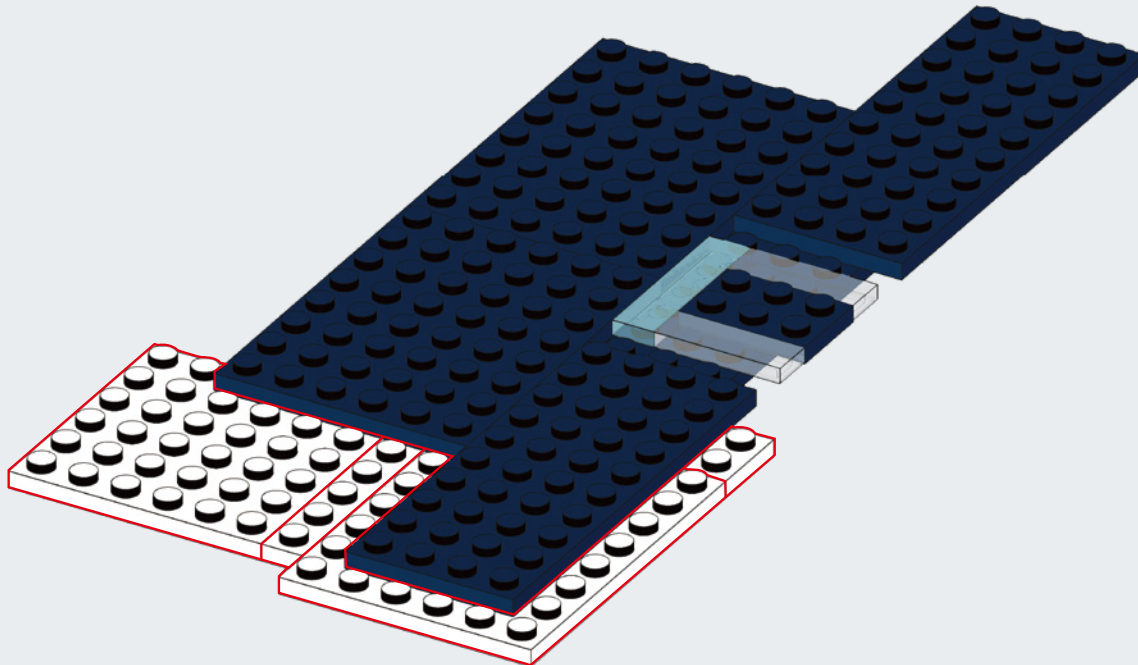
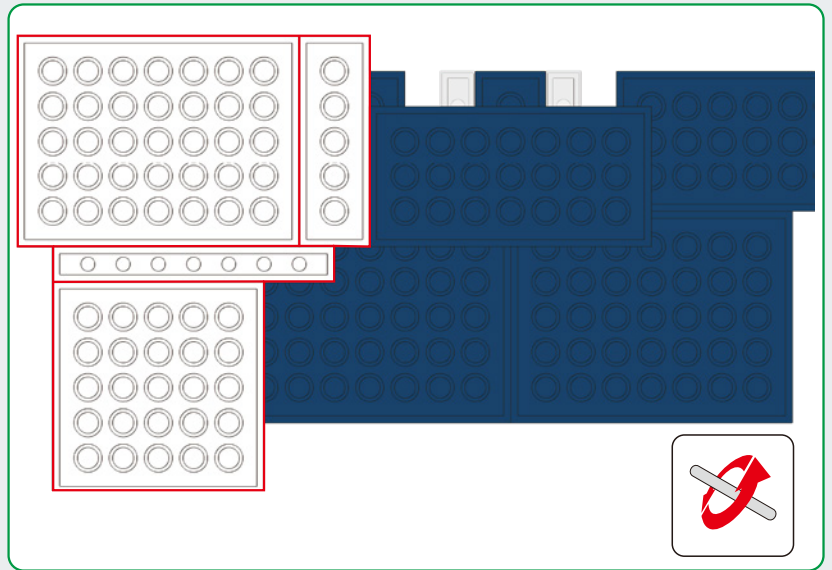

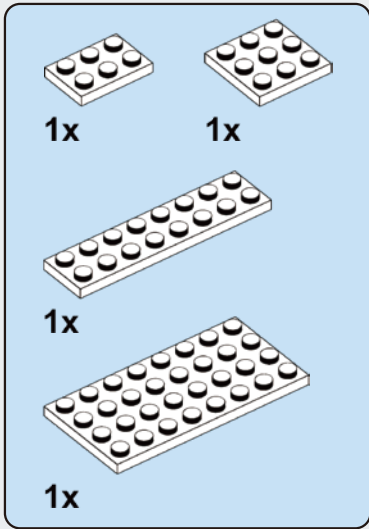

**B26**

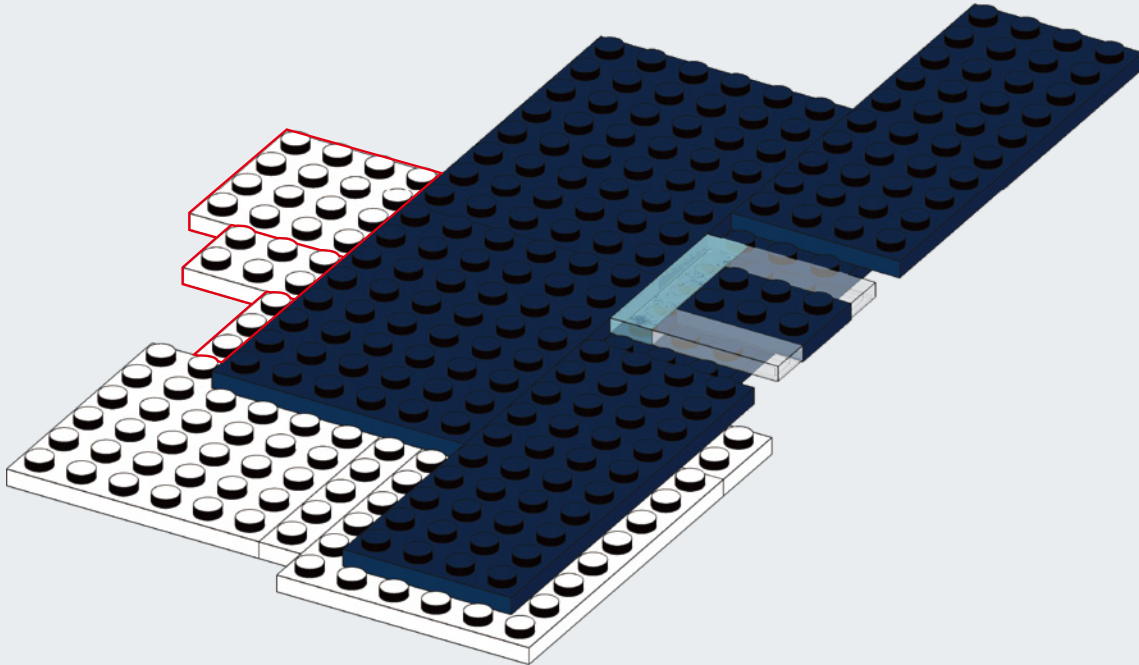
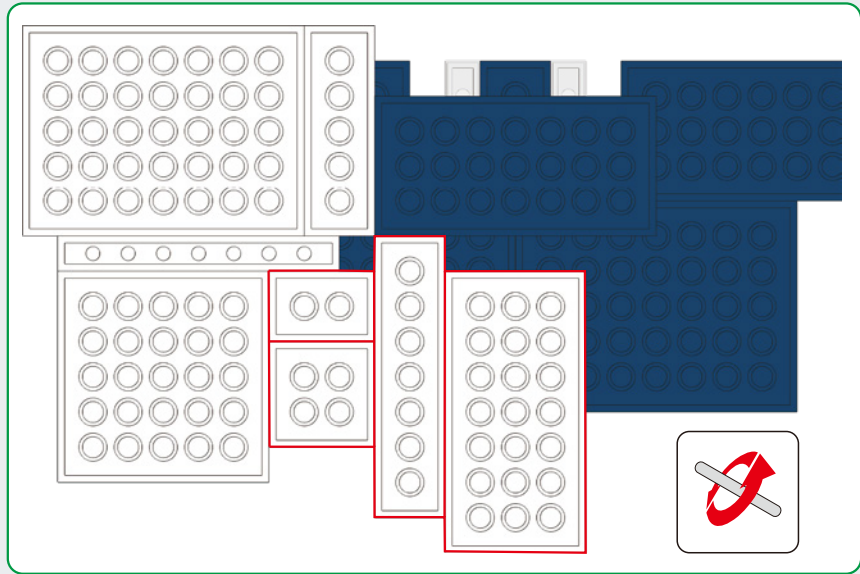

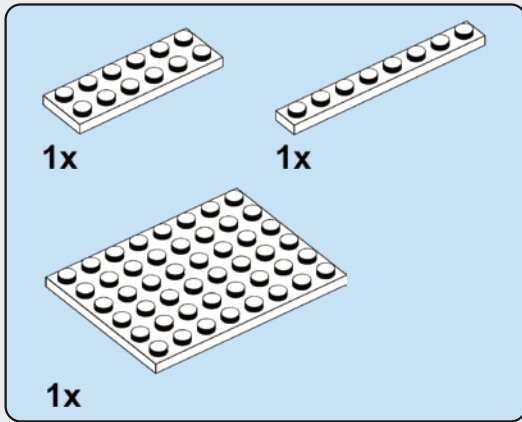

**B27**

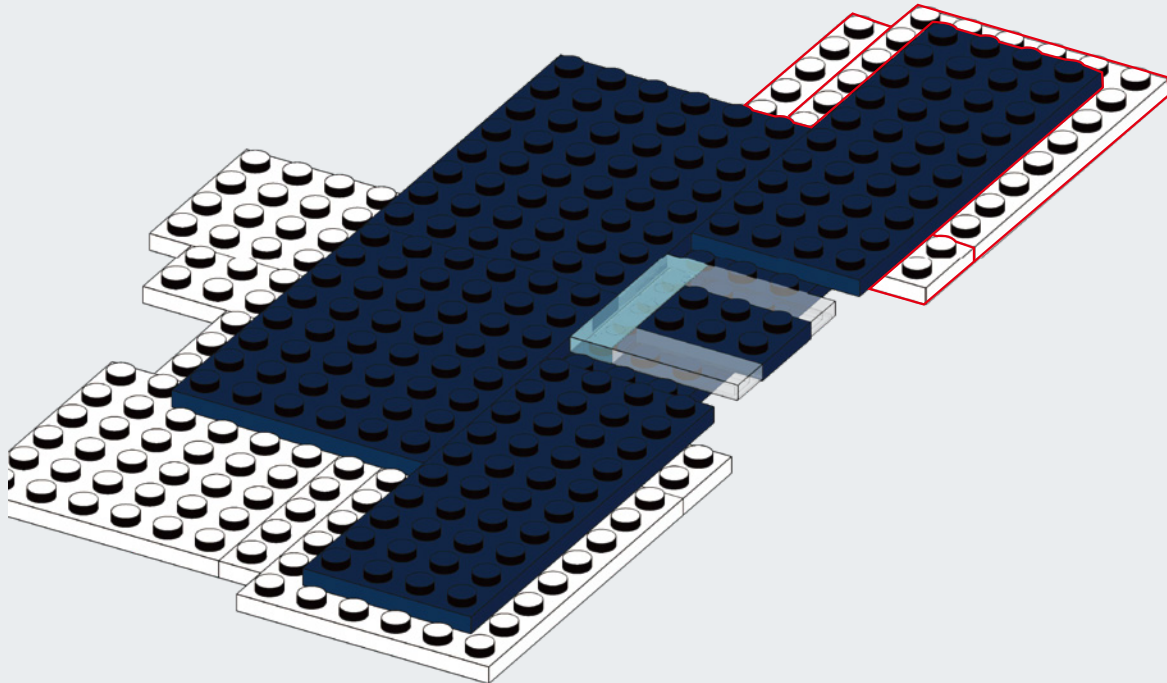
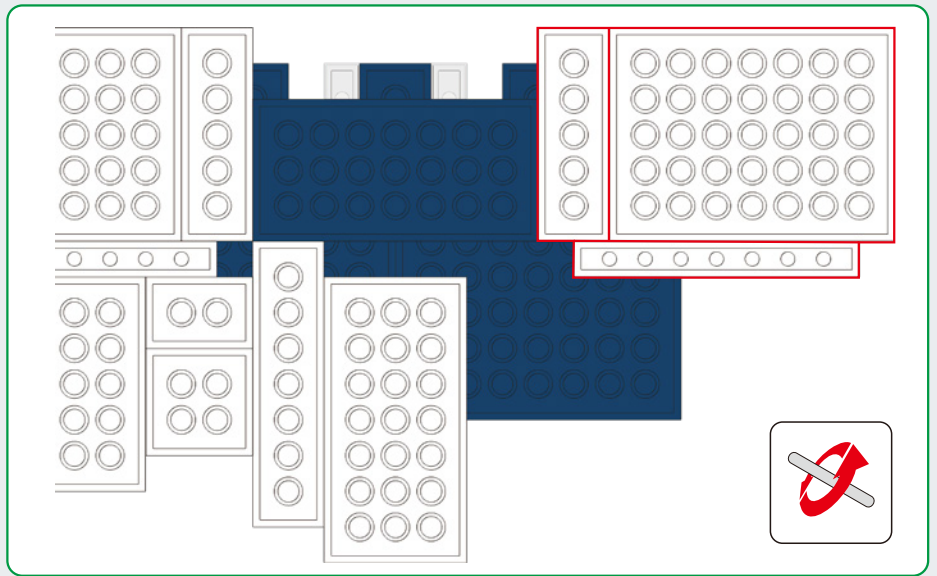

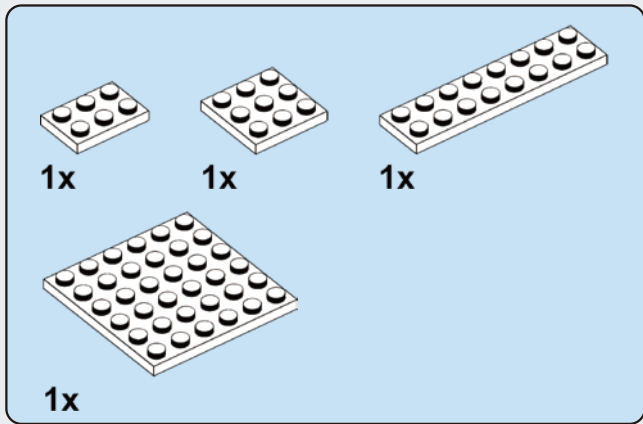

**B28**

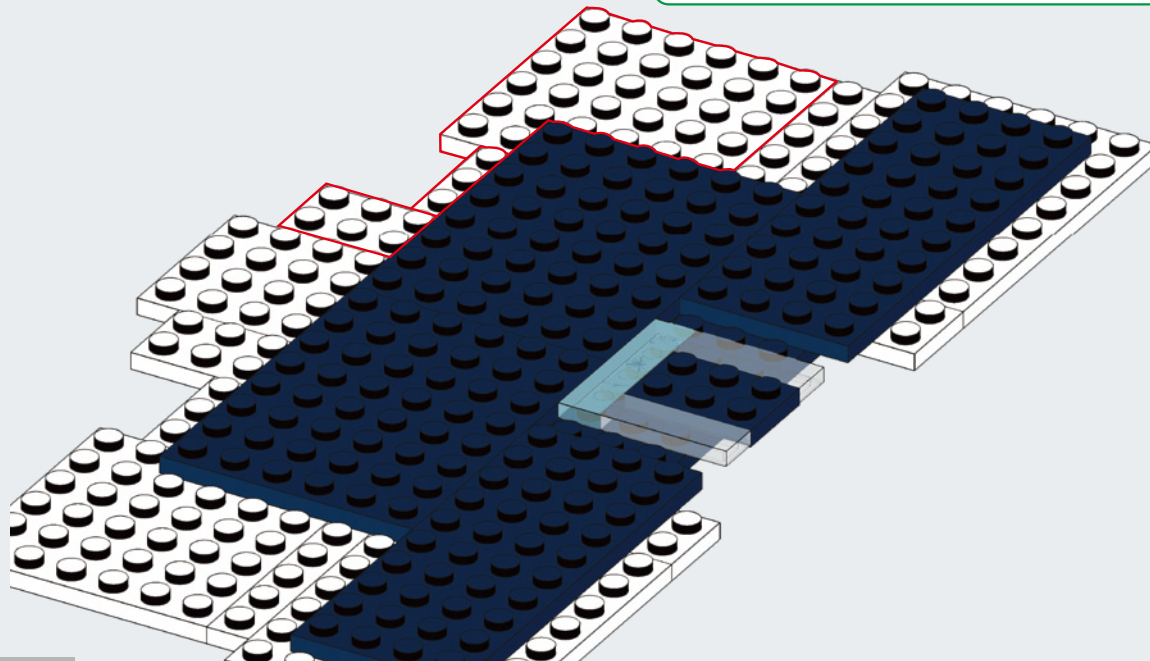
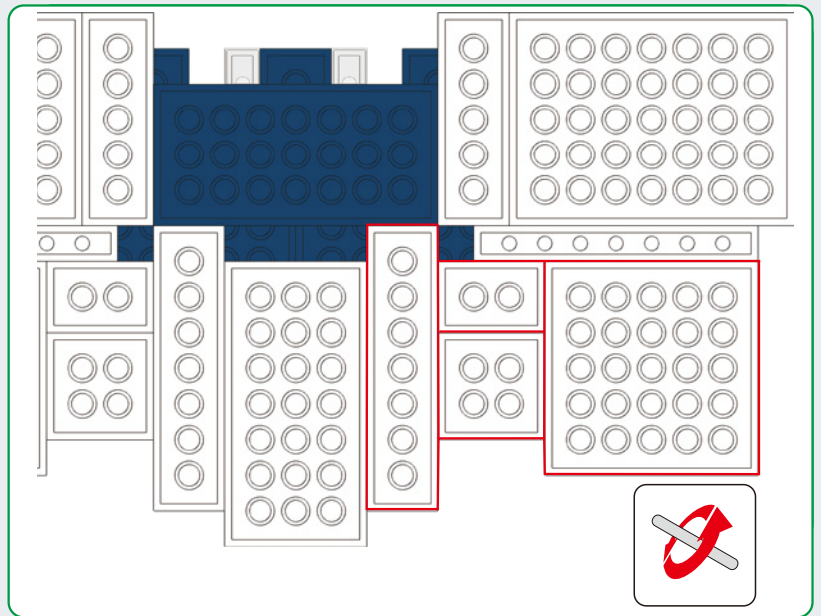

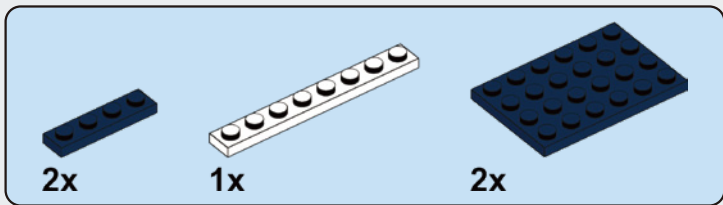

## B29

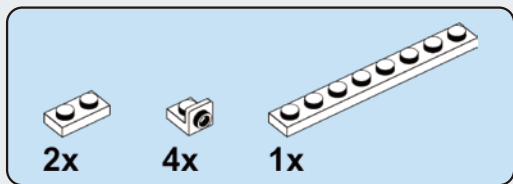
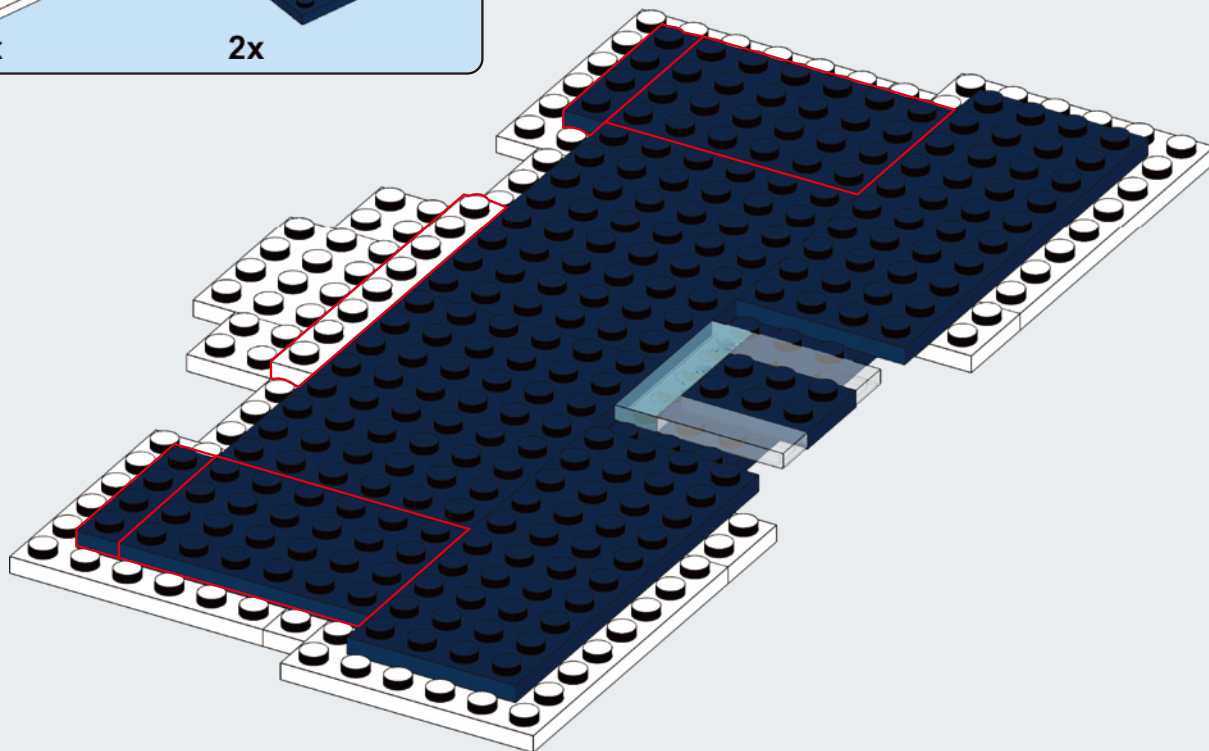

## B30

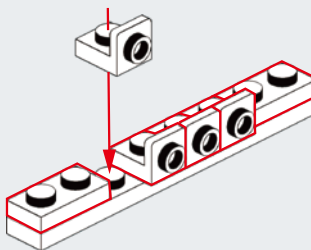

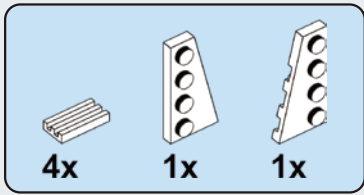

## B31

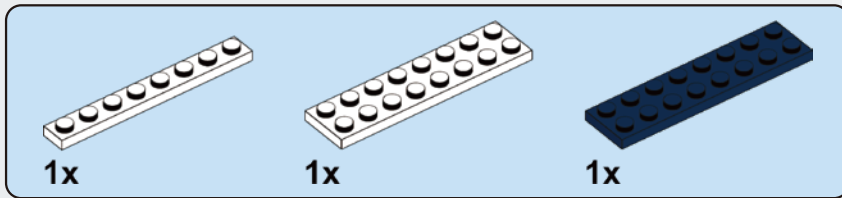
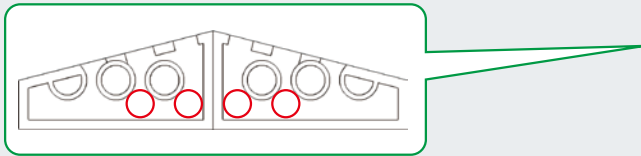
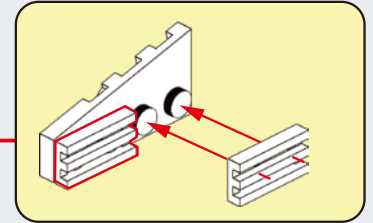
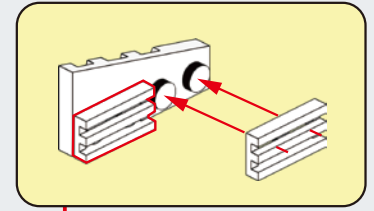
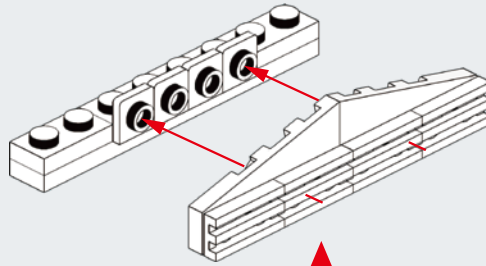

## B32

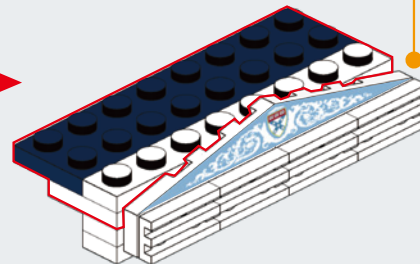
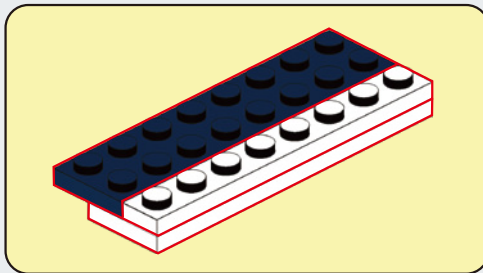

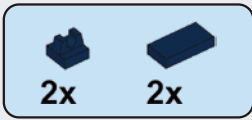

## B33

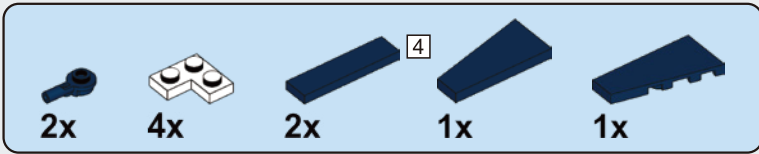
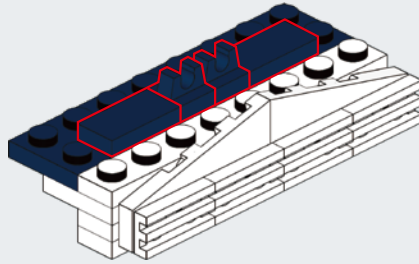

## B34

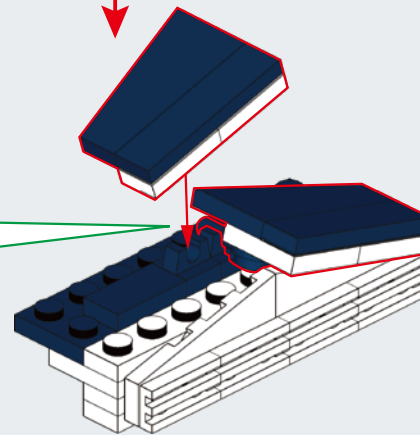
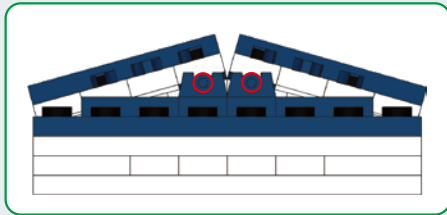
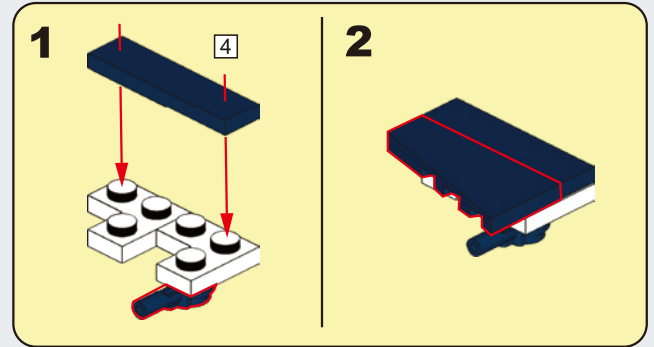
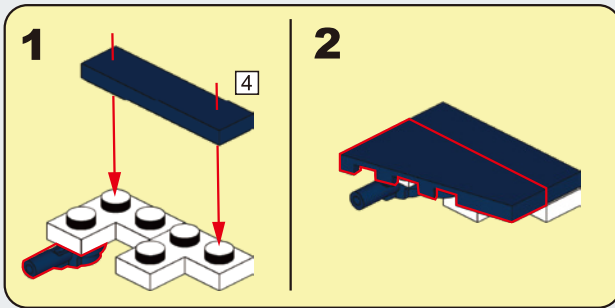



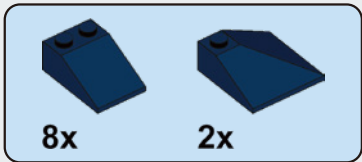

**B35**

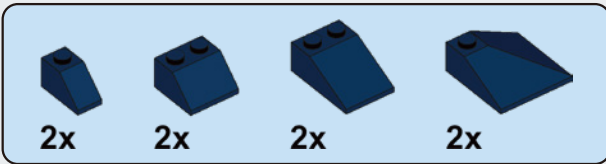
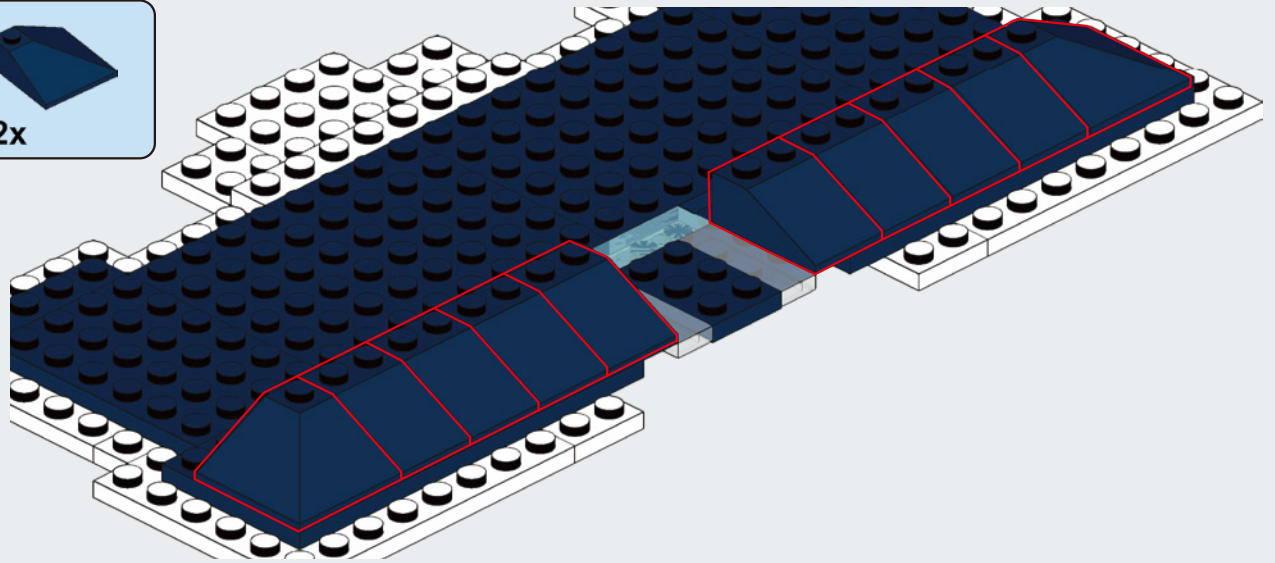

**B36**

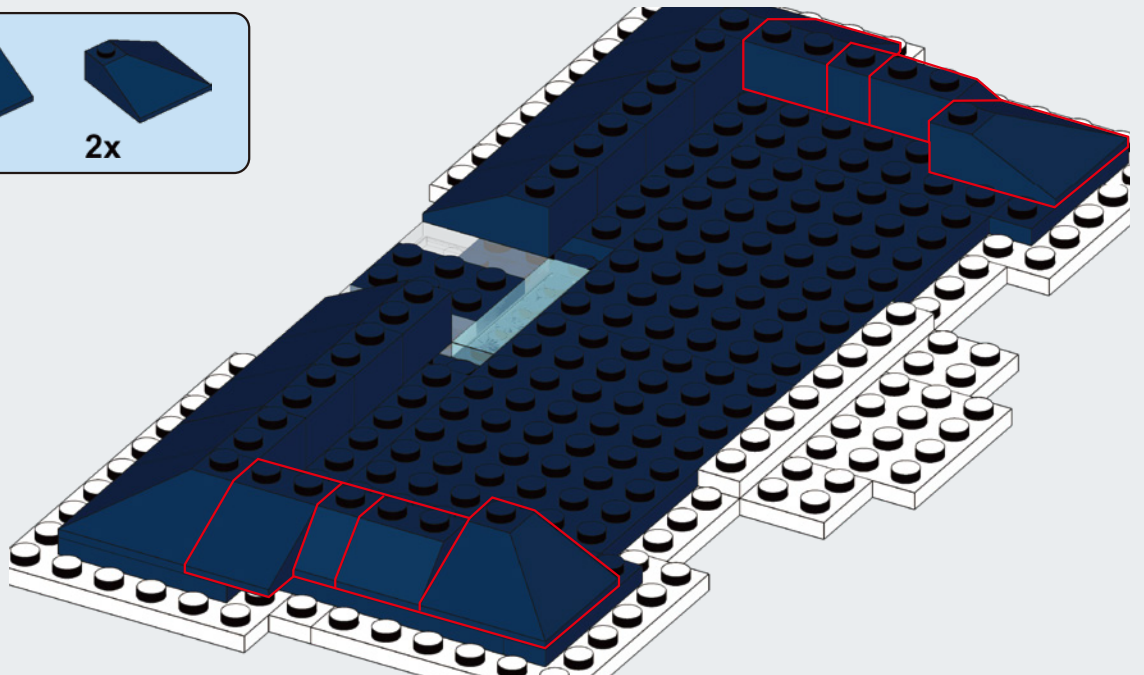
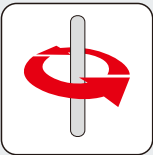

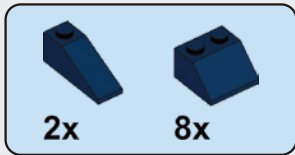

## B37

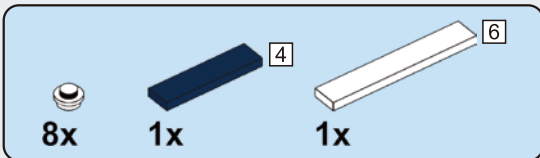
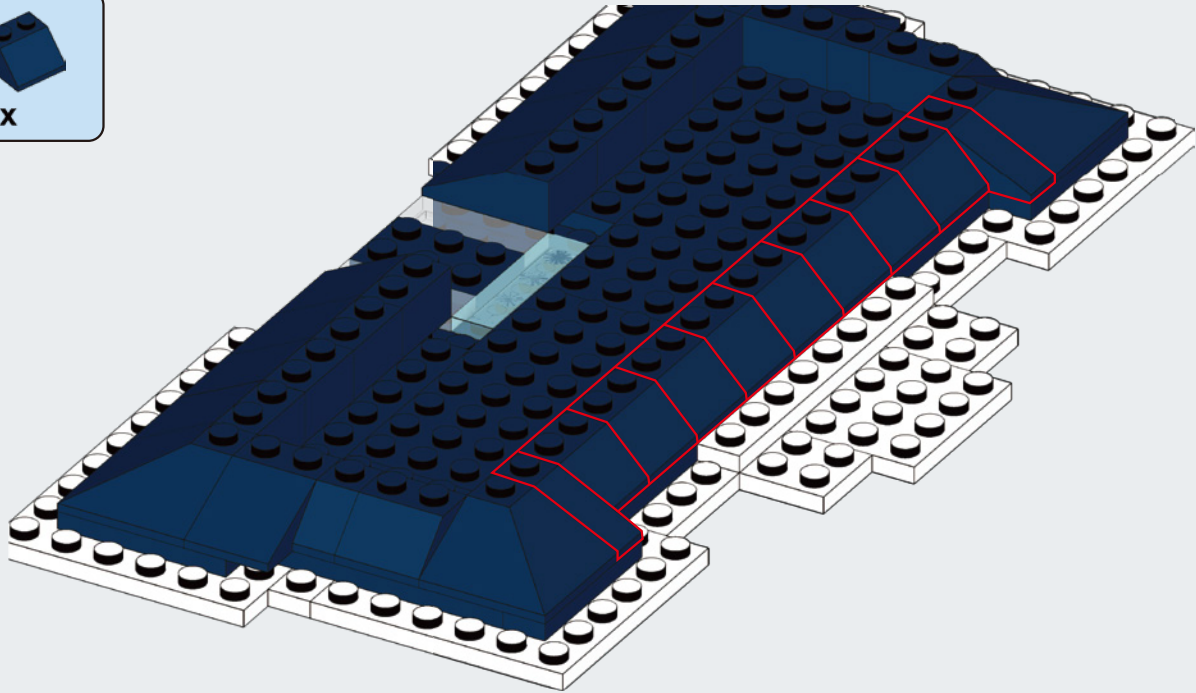

## B38

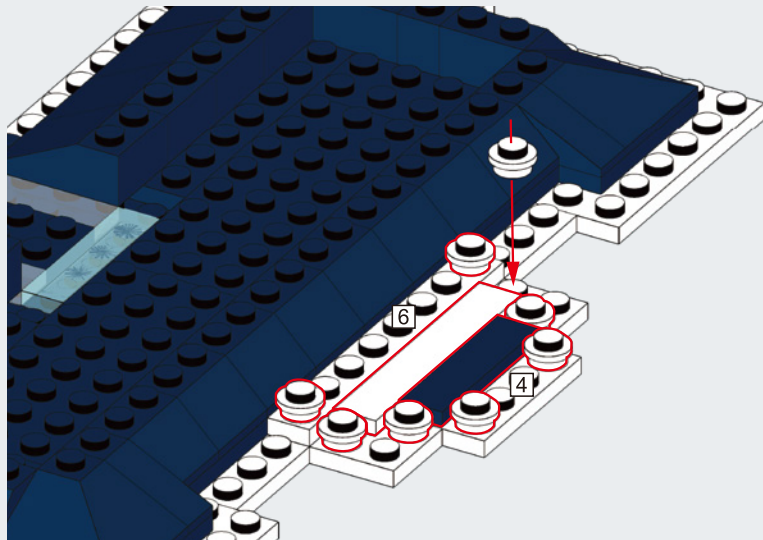

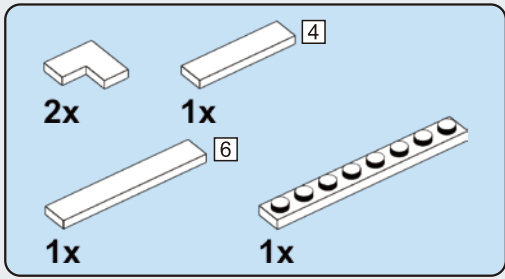

## B39

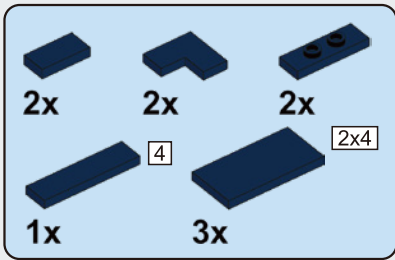
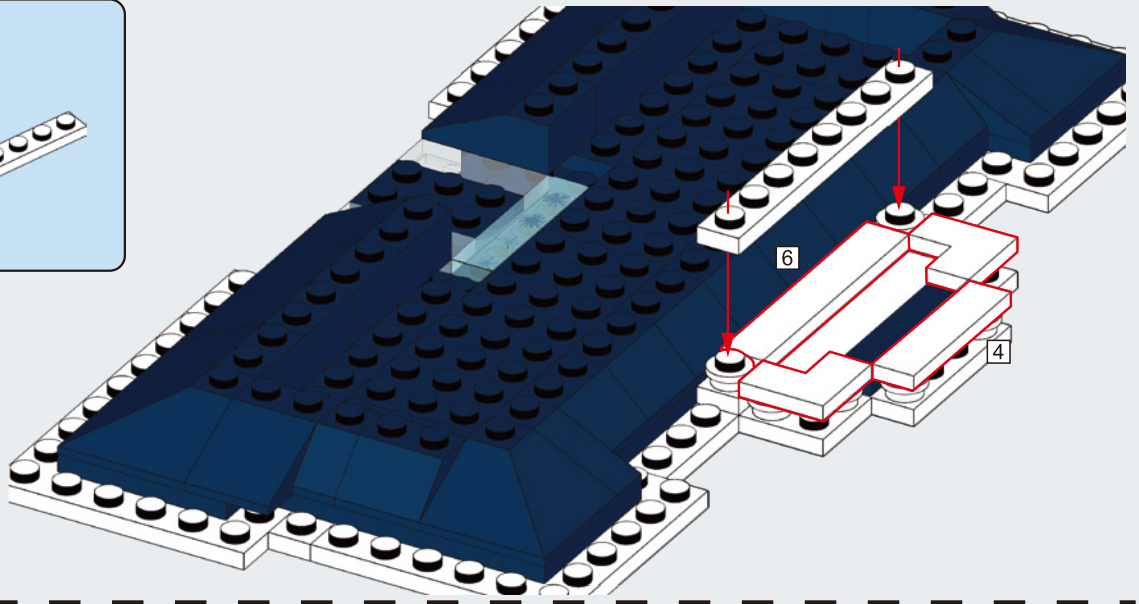

## B40

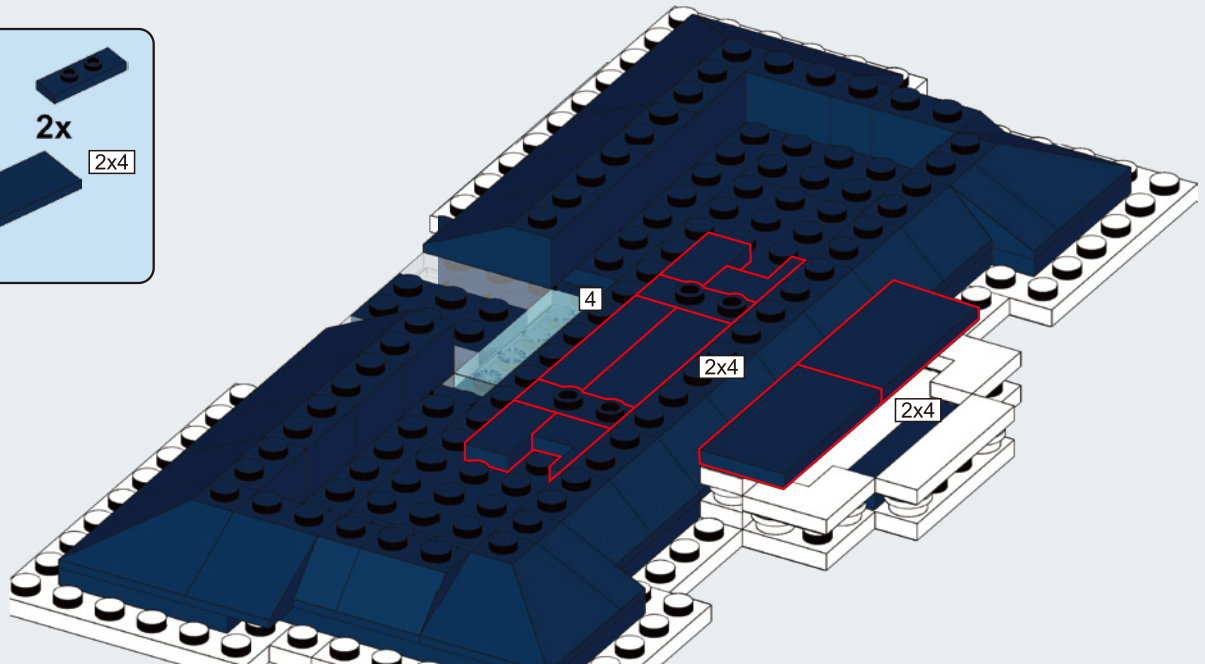

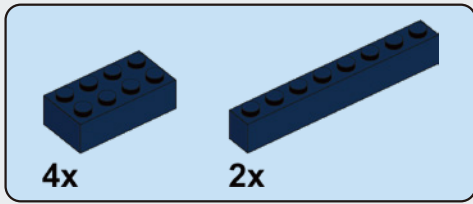

## B41

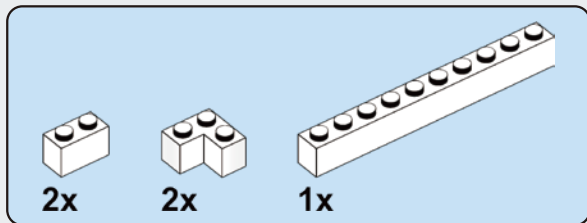
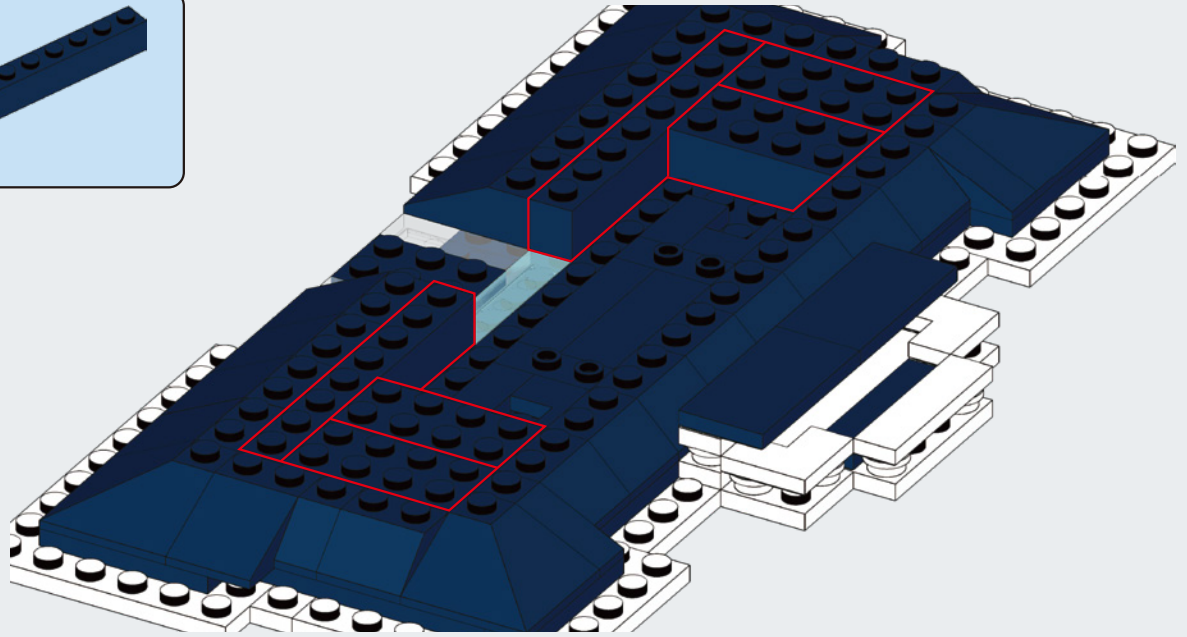

## B42

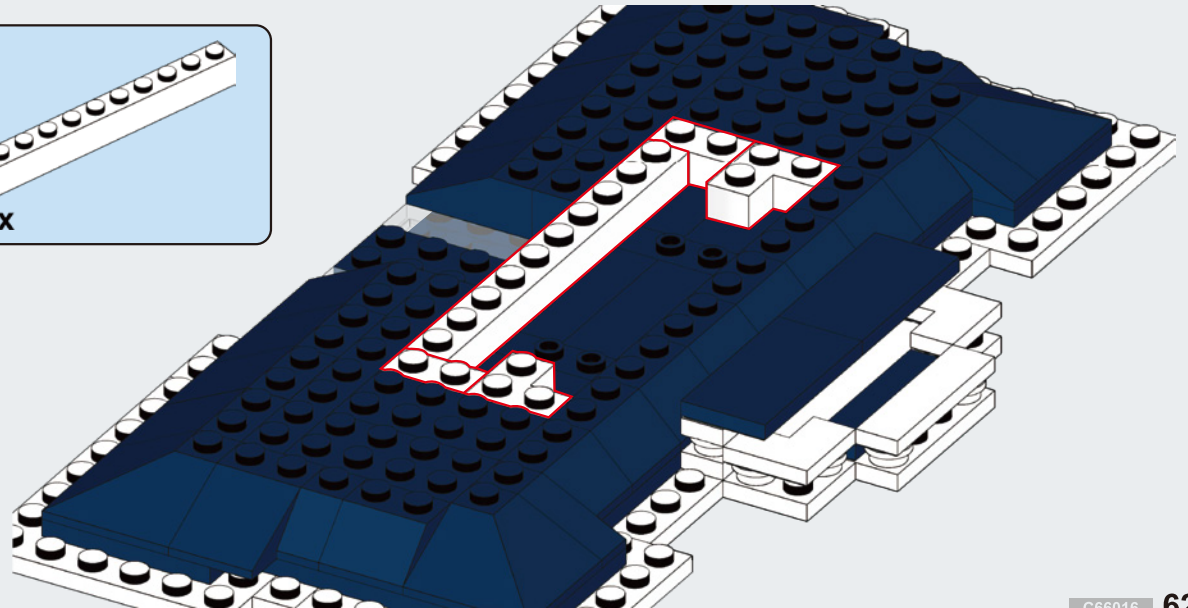

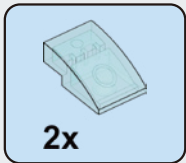

**B43**

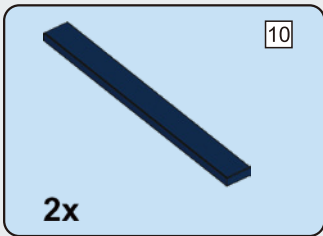
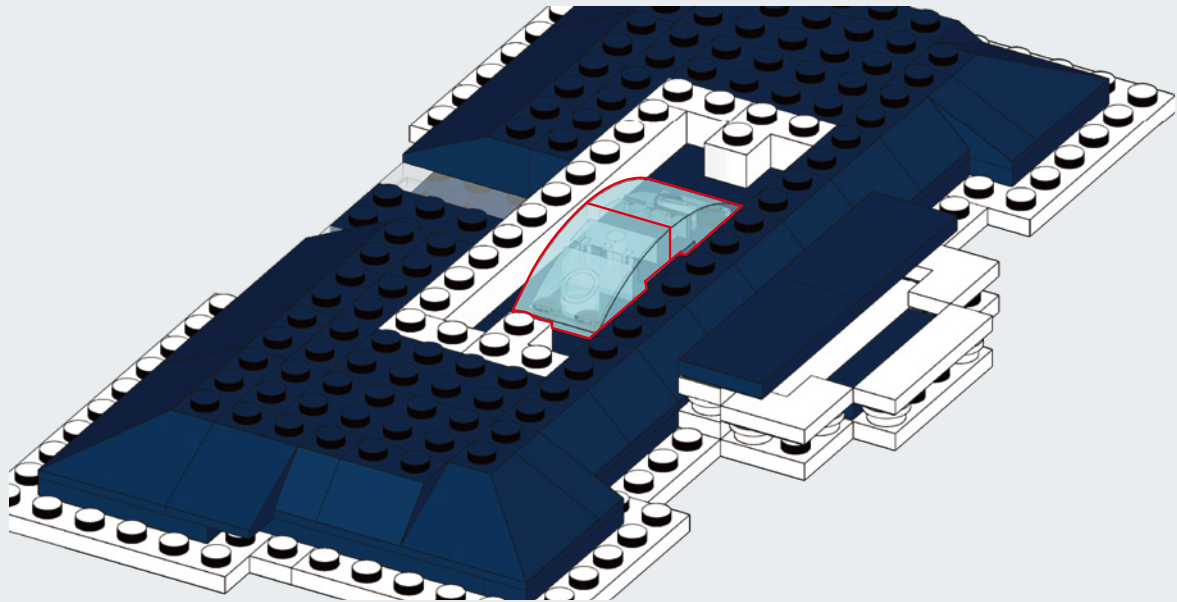

**B44**

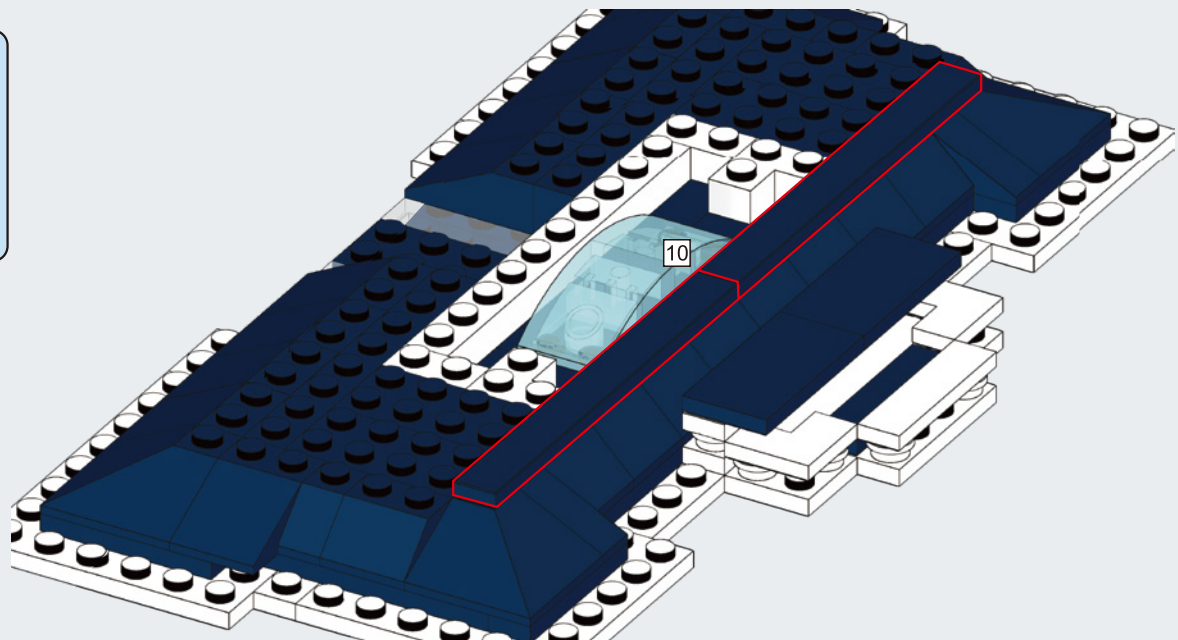



# B45

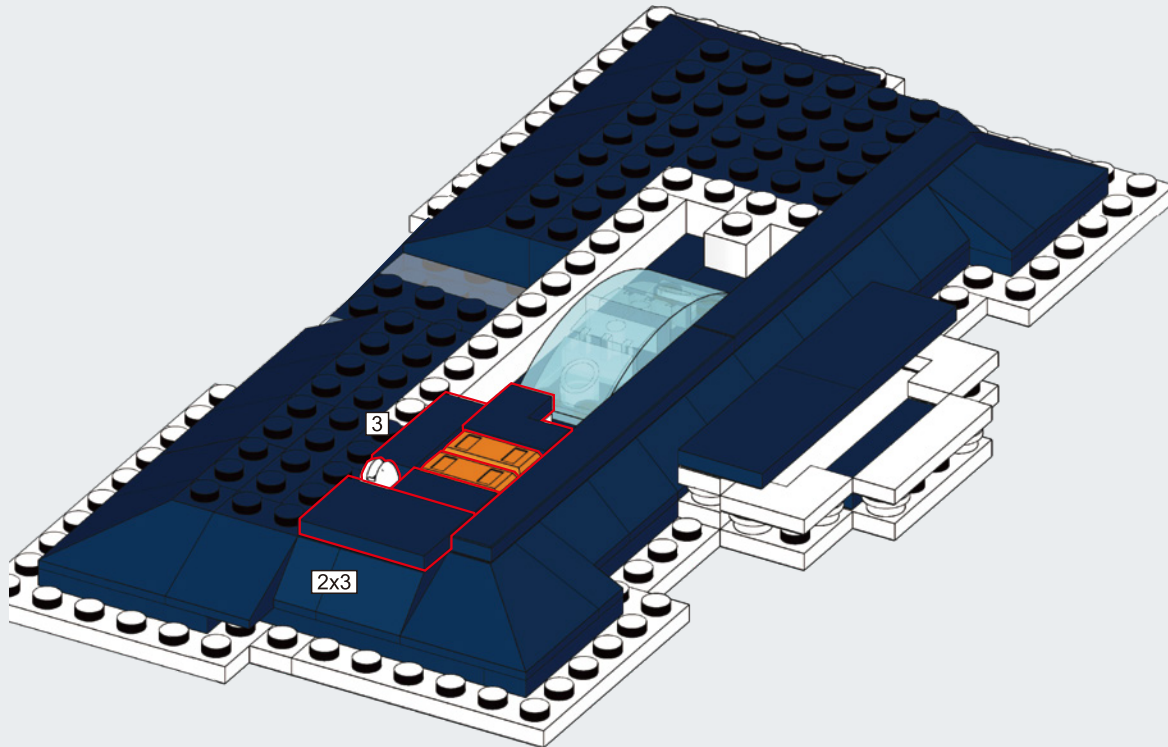



# B46

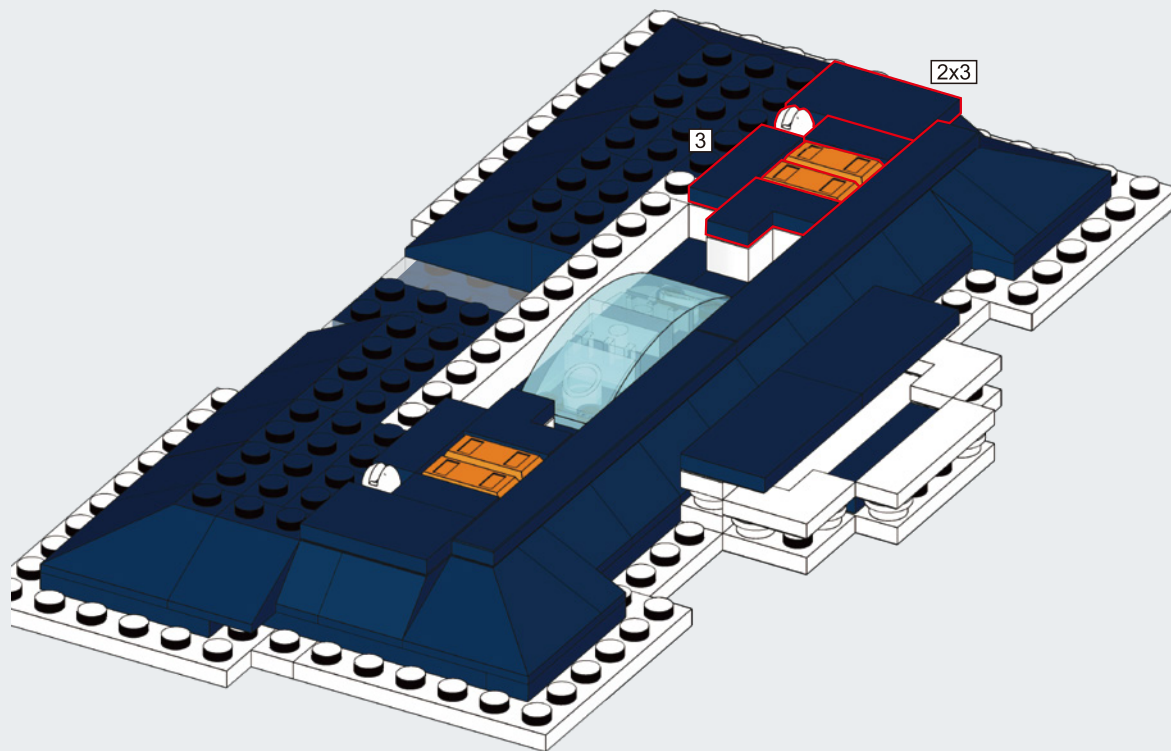

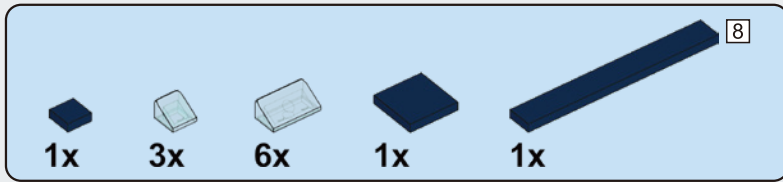

# B47

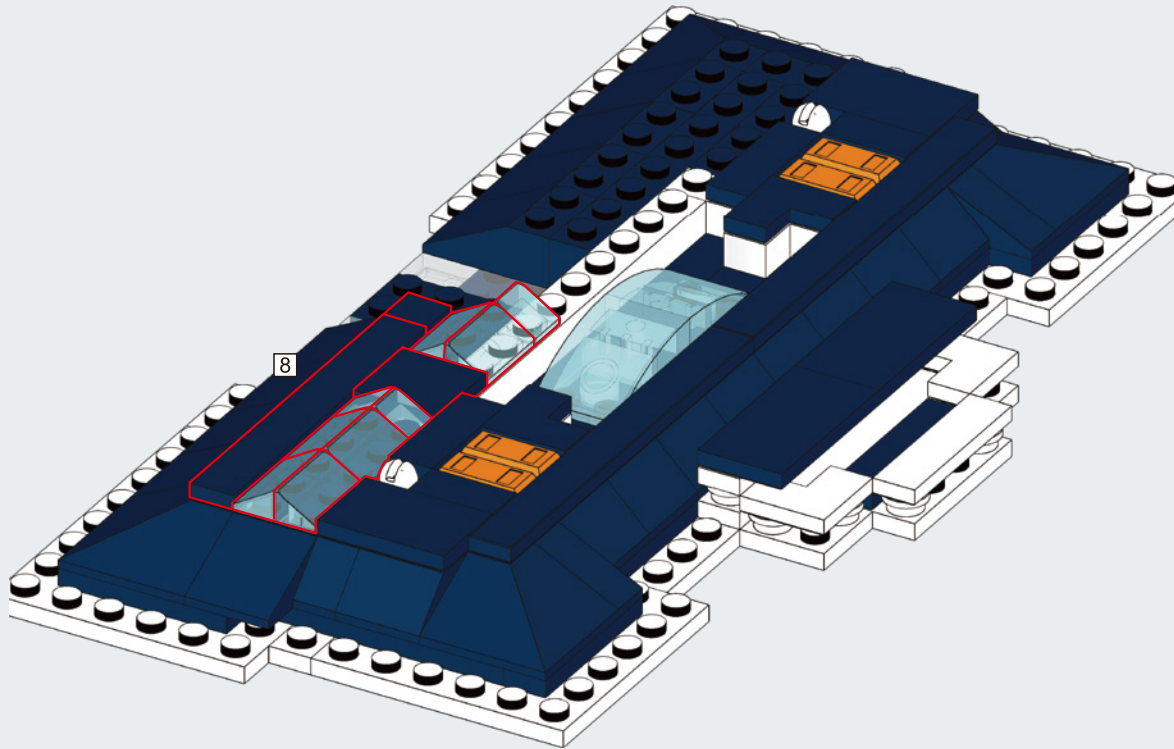



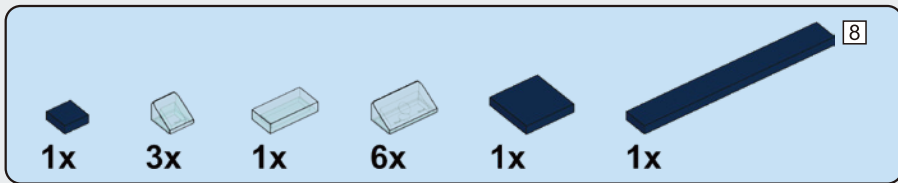

## B48

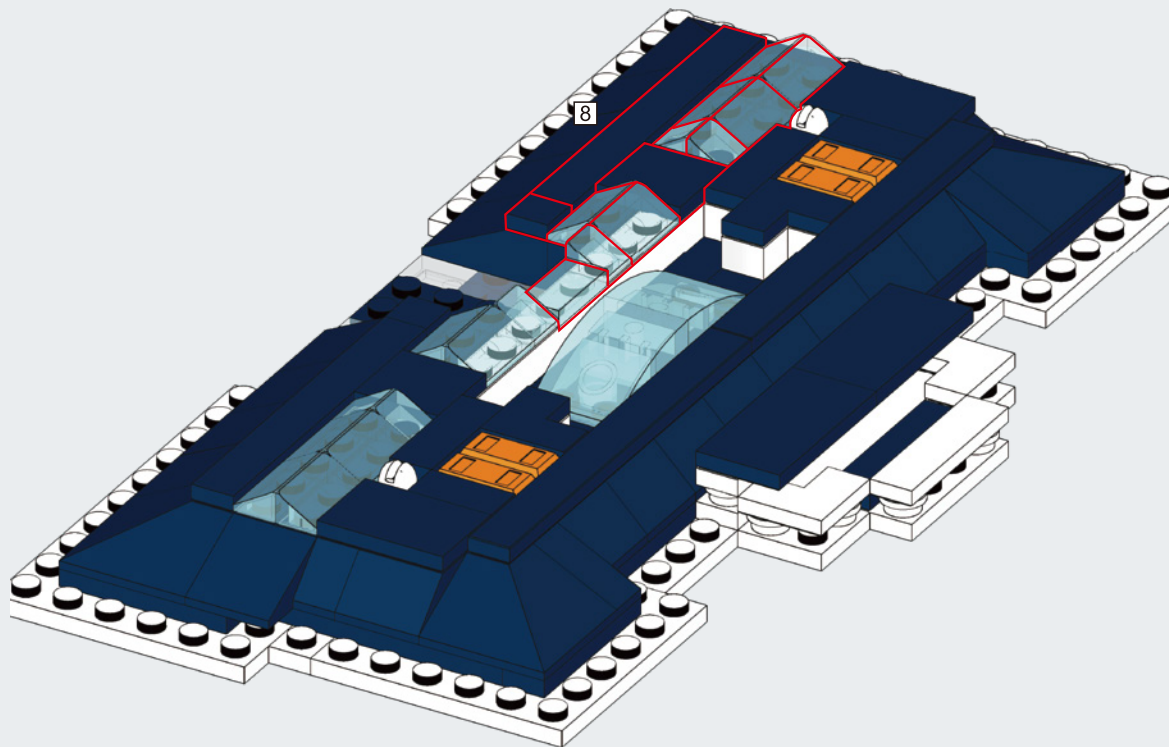

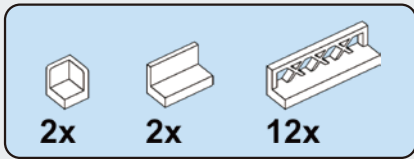

## B49

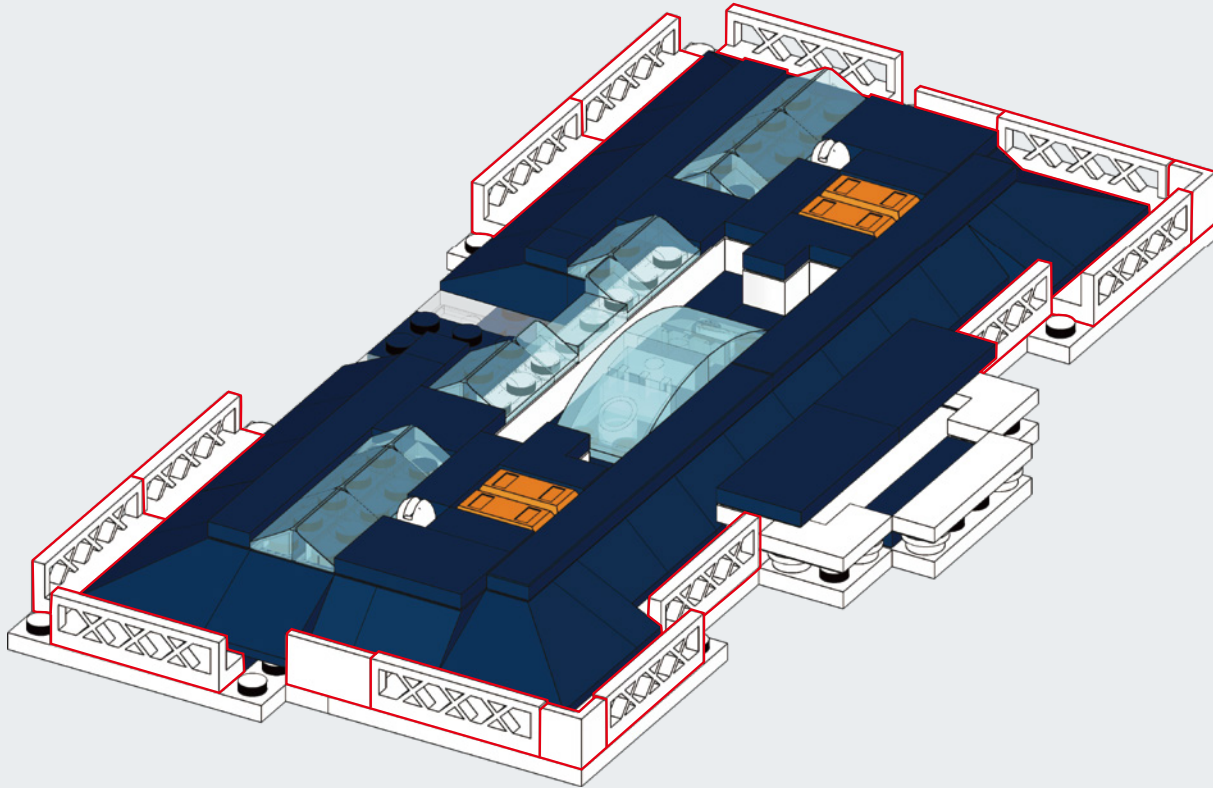

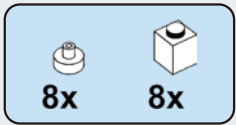

## B50

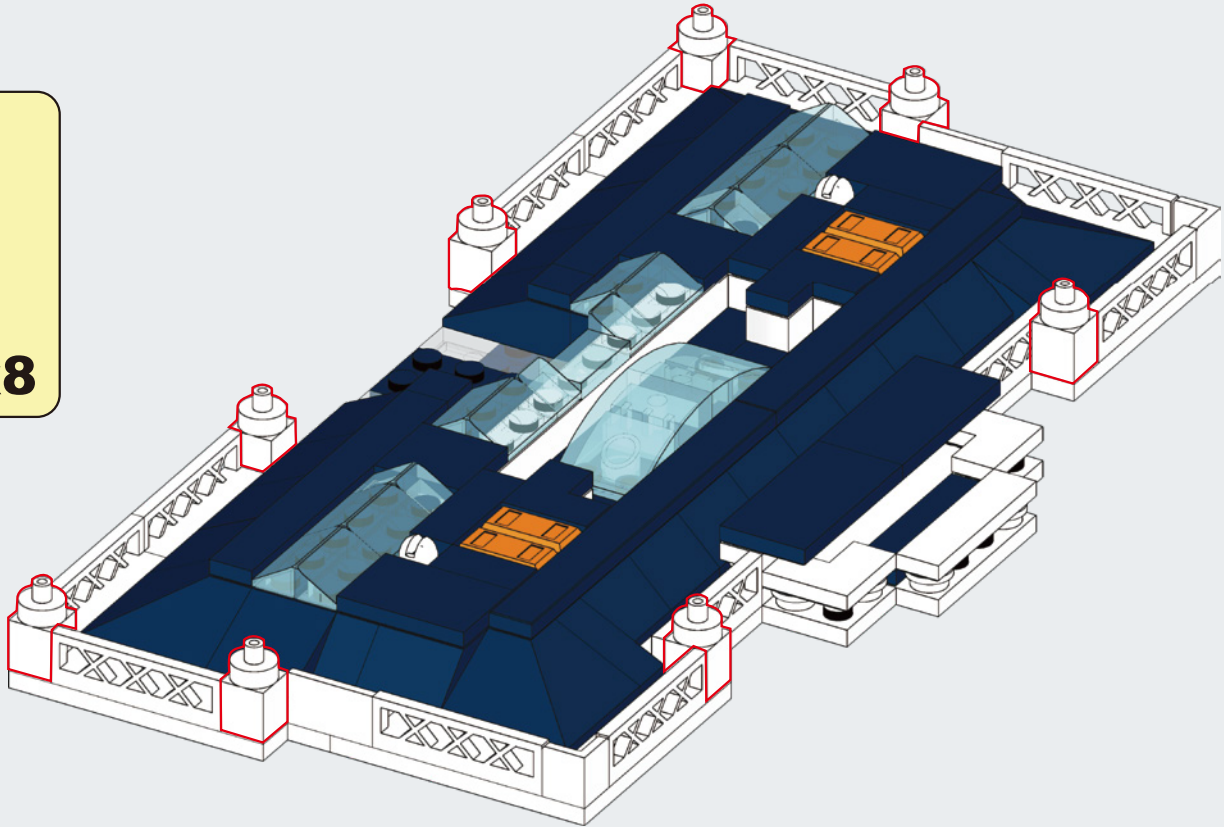
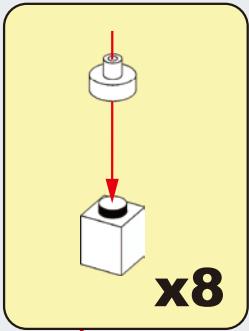

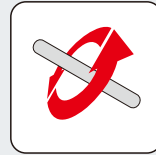
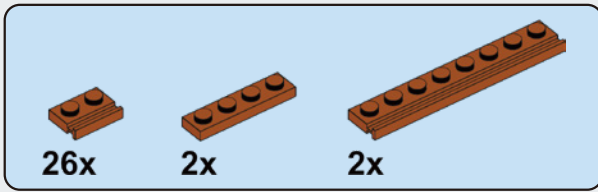

**B51**

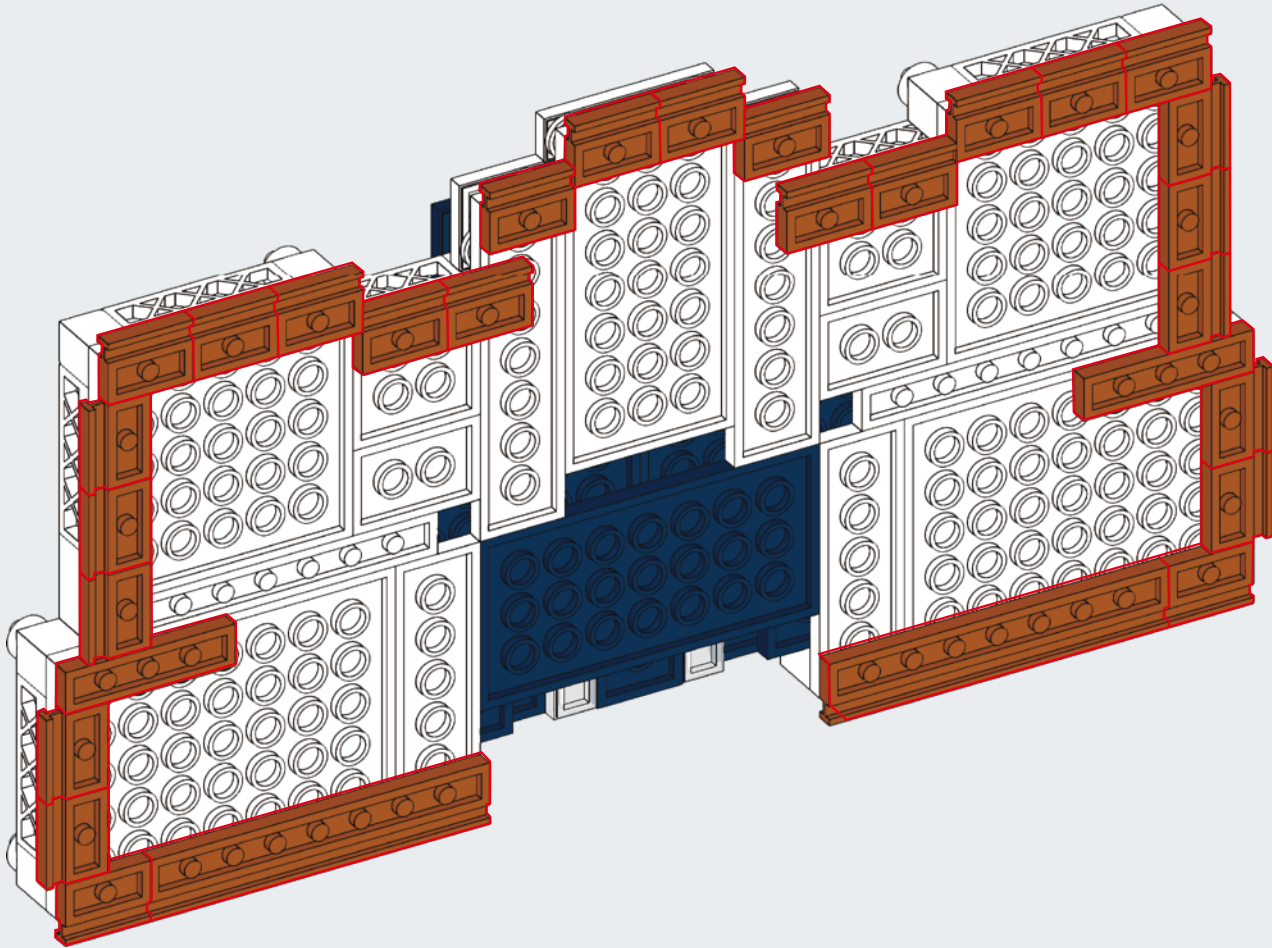

# B52

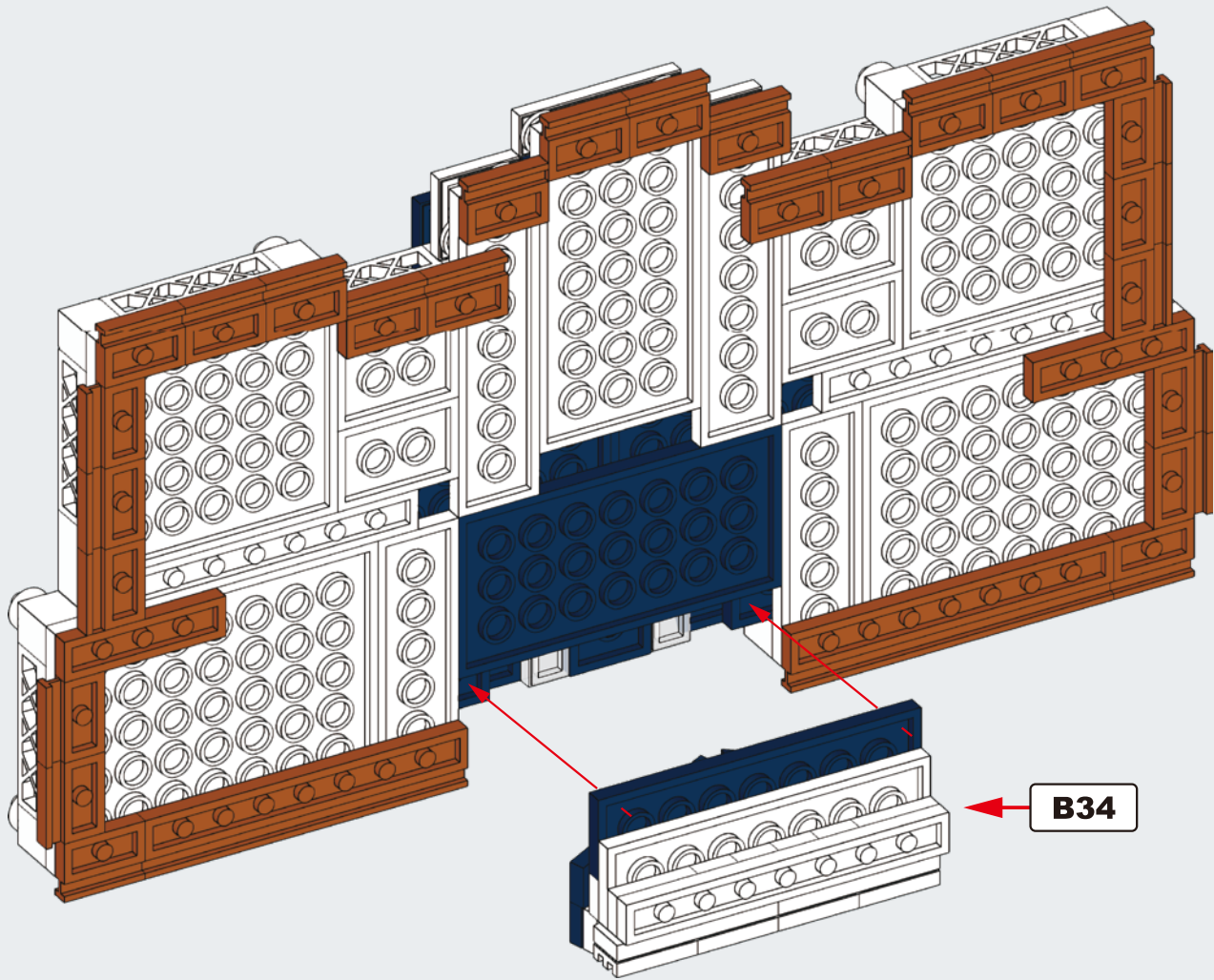

# B53

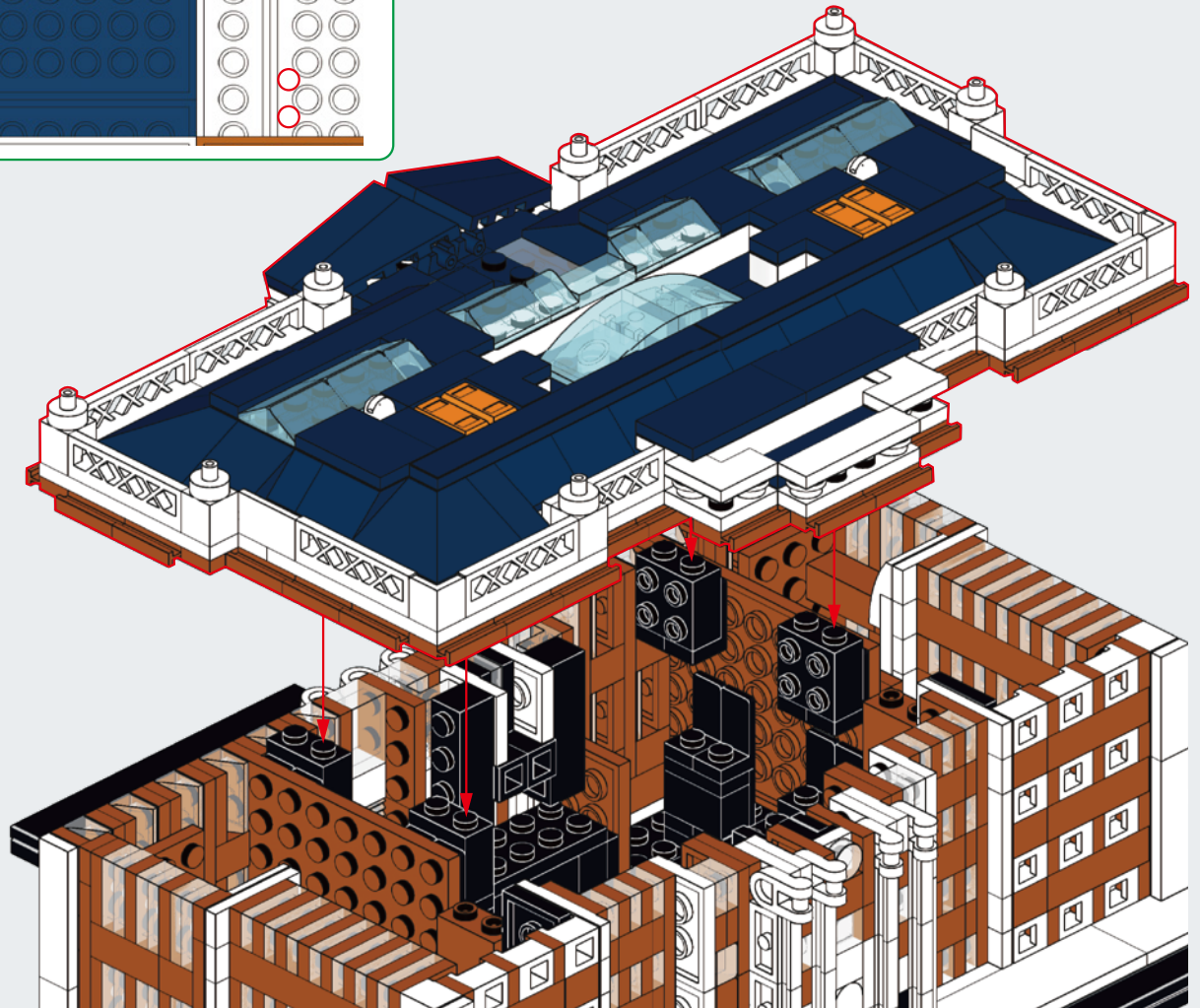
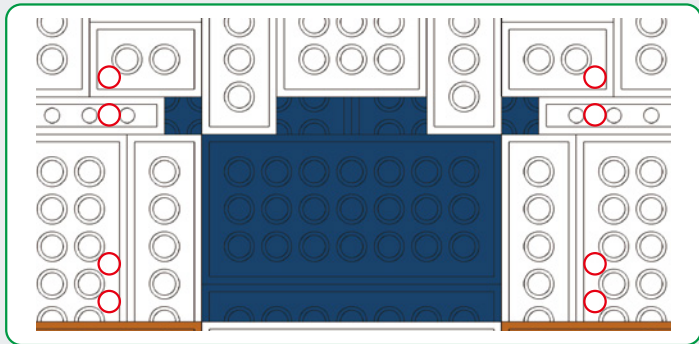

**B22** →

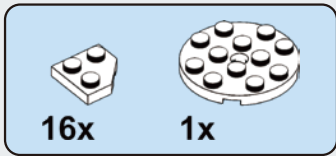

**B54**

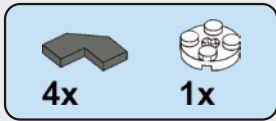
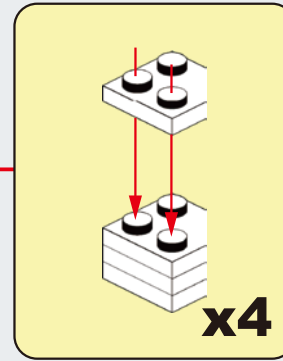
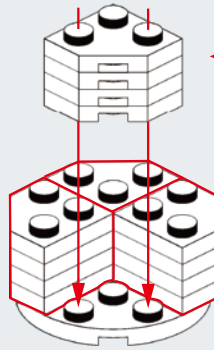

**B55**

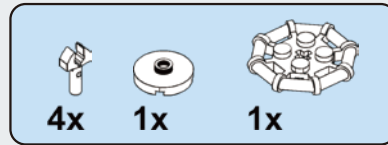
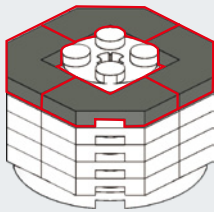

**B56**

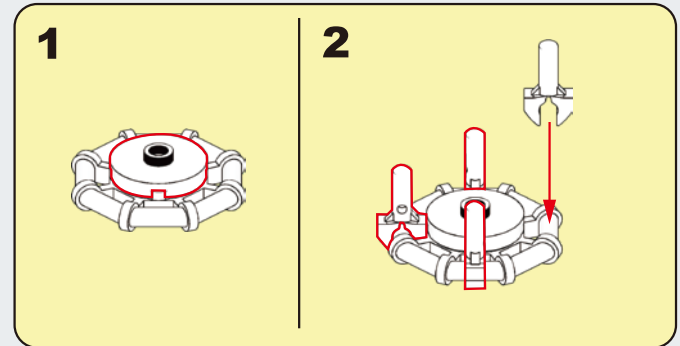
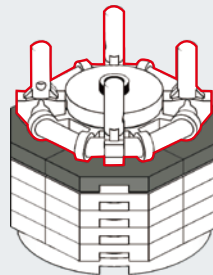

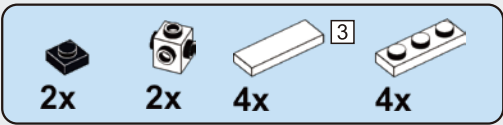

# B57

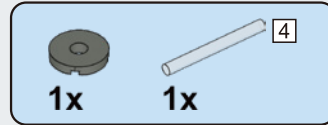
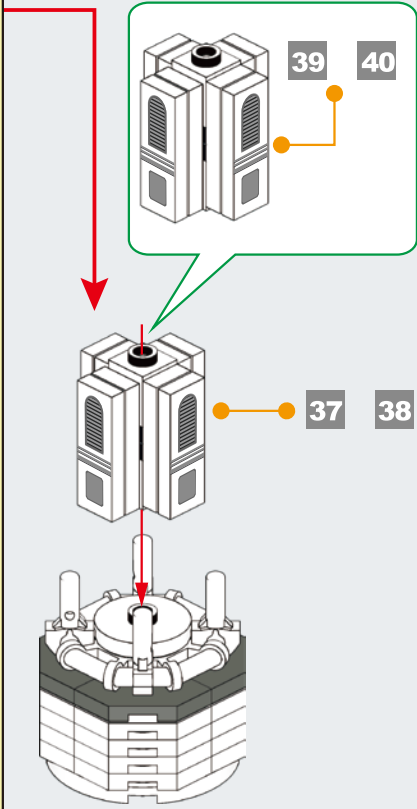
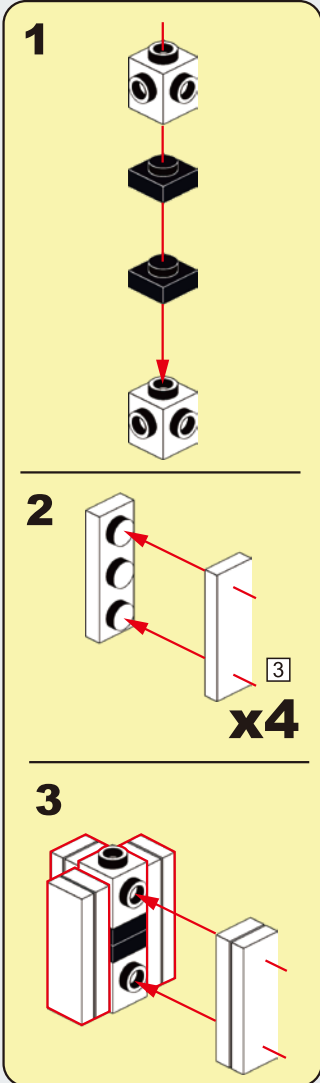

# B58

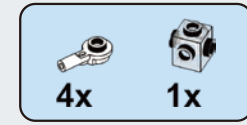
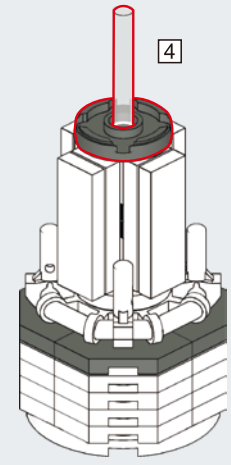

# B59

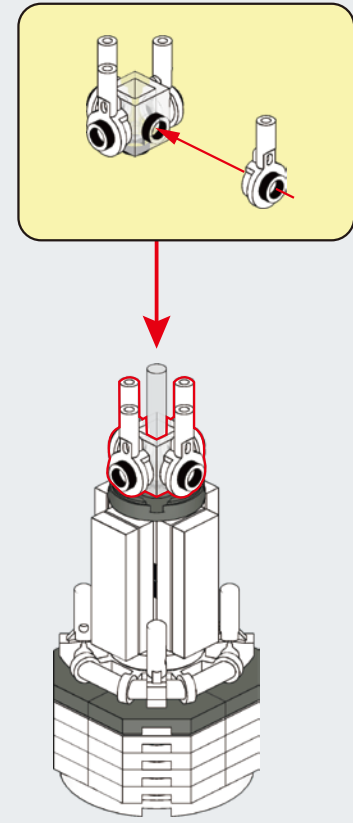



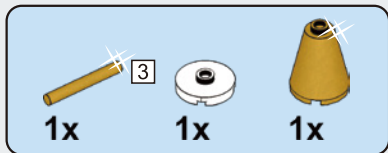

**B60**

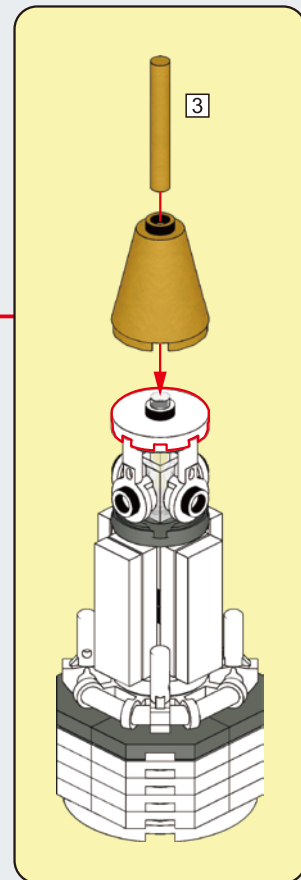
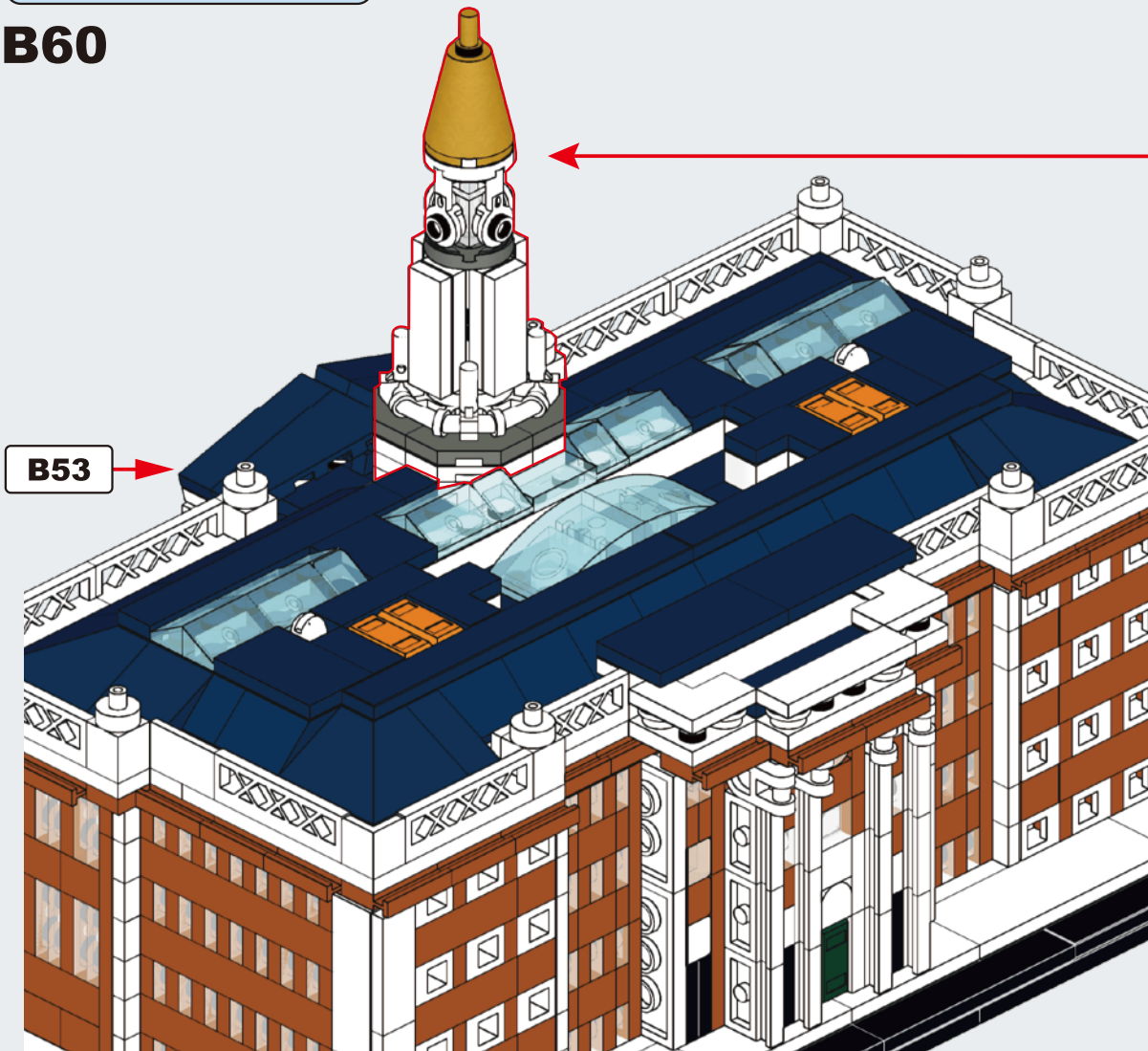

**B61**

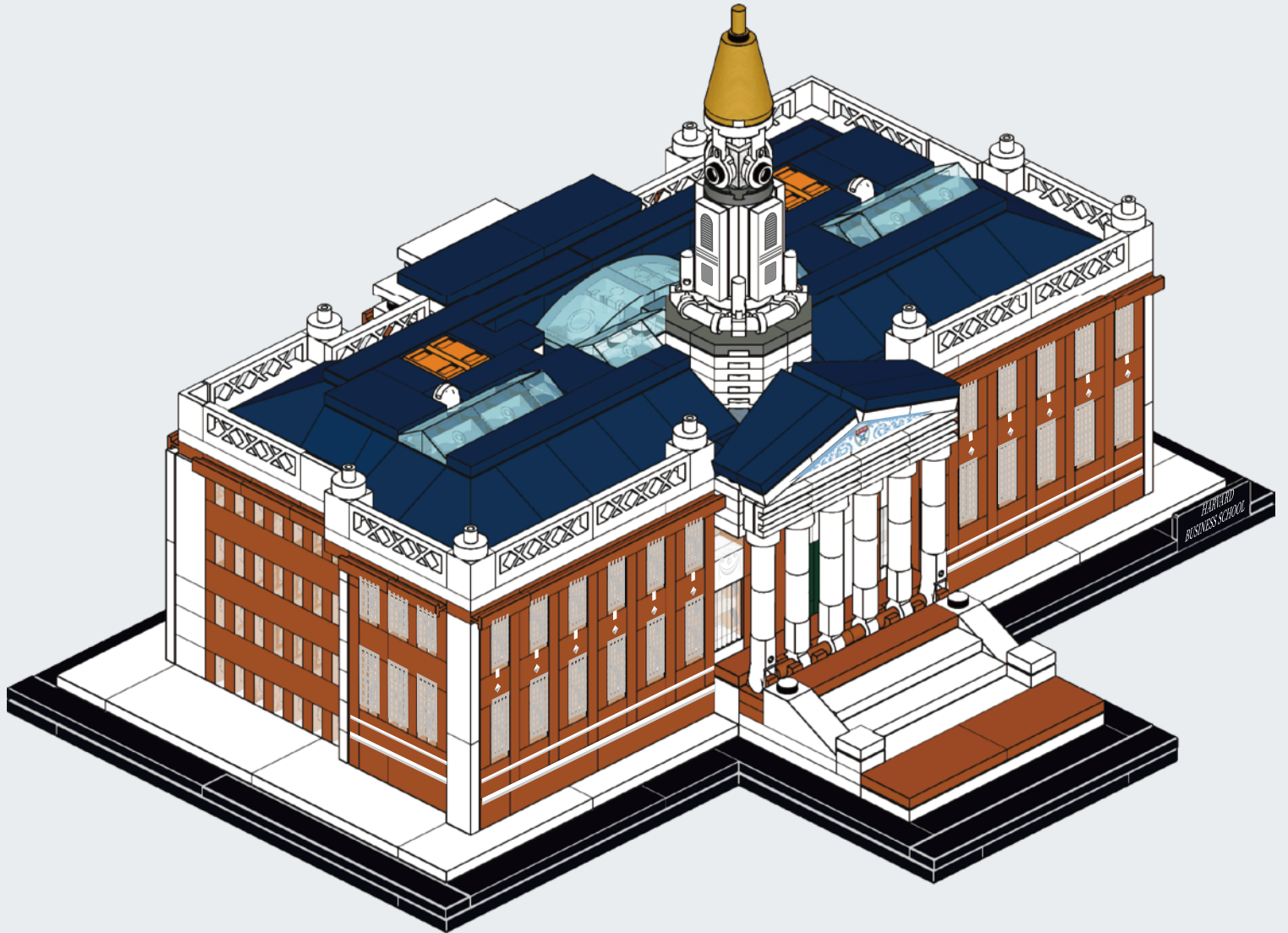

 2x JX80840002	 8x JB10010003	 6x JD10010025	 2x JF00920001	 6x JA30290022	 8x JA10140001	 4x JA30780019	 4x JA40480005
 1x JB10160006	 14x JF10700006	 2x JD10010024	 12x JA20170002	 2x JA30290007	 1x JA30290025	 1x JB10120007	 2x JD20030012
 1x JA30280009	 2x JD10010016	 2x JD10010001	 24x JF00650005	 4x JX80010002	 12x JD10020032	 2x JA20820001	 2x JF10890020
 1x JA30280028	 4x JF00820004	 4x JF00820005	 6x JF00920008	 88x JA10140013	 24x JD10020013	 2x JX31050014	 1x 202RJF10890002
 7x JA30280010	 6x JF20110024	 2x JF20110011	 1x JF00790007	 10x JA10140002	 2x JA30570008	 3x JA20180007	 2x JA30300009
 2x JA30280022	 2x JX81340007	 4x JF10660001	 6x JF00920008	 117x JA10140033	 2x JA30570008	 6x JA20180001	 2x JA30300009
 2x JA10150009	 4x JX81340006	 4x JF00810002	 6x JF00920014	 26x JF90560017	 12x JF90560005	 4x JA20180021	 16x JE40140001
 58x JA10150031	 4x JX80950007	 4x JF11220003	 32x JA20170021	 3x JA30290032	 1x JB10190004	 2x JA40480018	 4x JE30150001
 28x JA10150016	 4x JX80750010	 10x JF11220001	 2x JA30600005	 1x JX81000011	 2x JB10200005	 22x JA40480013	 2x JA30780005
 7x JA10150006	 2x JX80970014	 28x JF11220002	 4x JA40360001	 2x JF00990017	 4x JA30490007	 1x JA30300002	 6x JA40770004
 2x JA30580005	 12x JX91060004	 2x JF00790004	 4x JX81000012	 2x JA30290001	 2x JB10200005	 1x JA30300002	 6x JA40770004

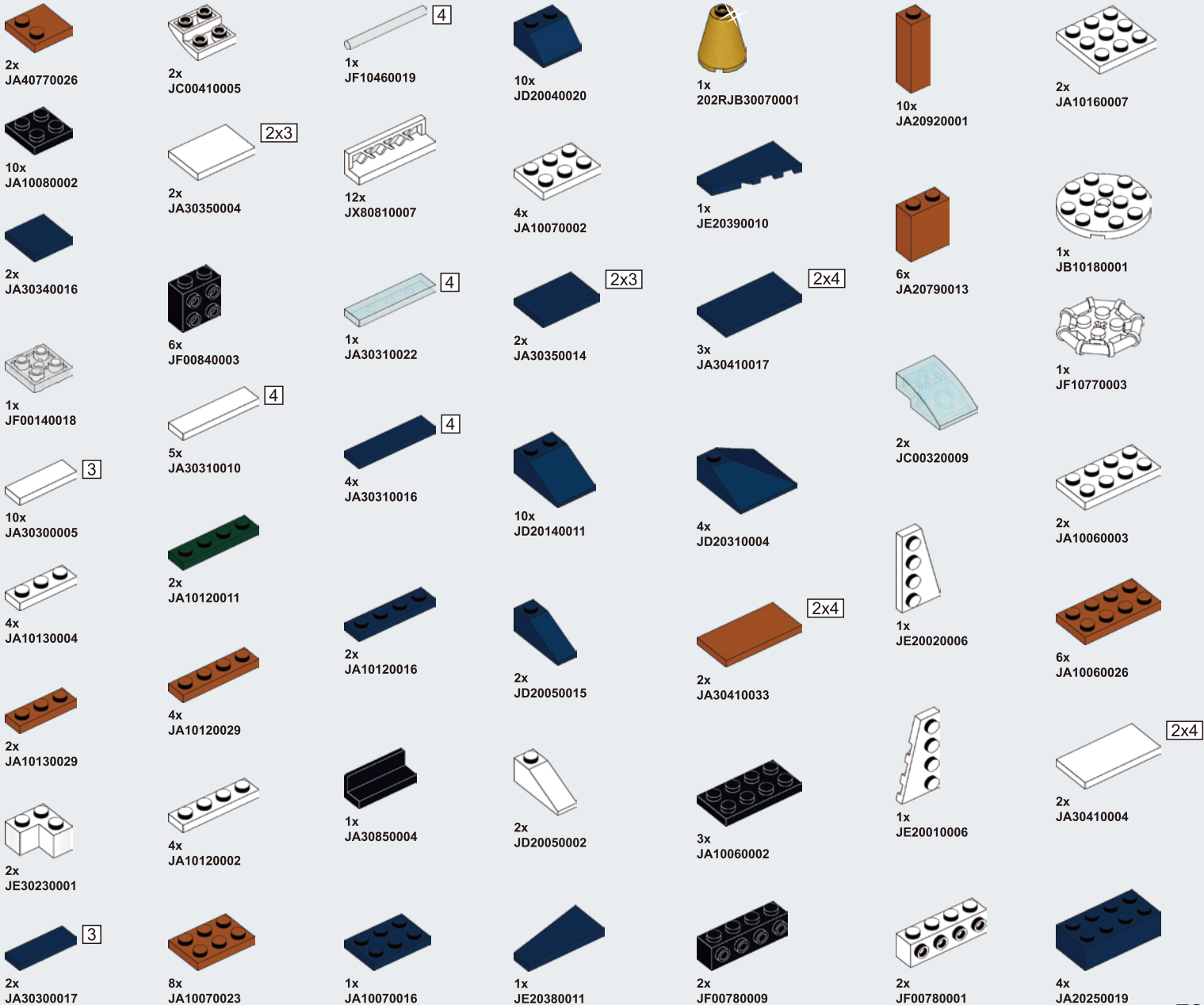

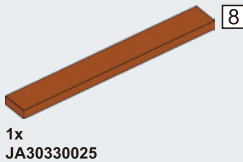
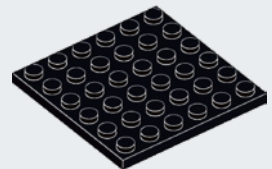
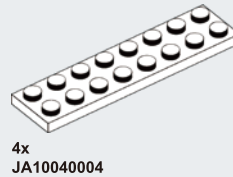
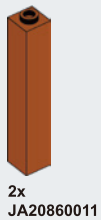
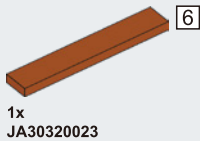
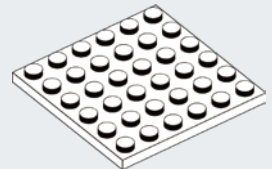
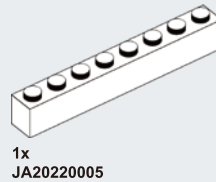
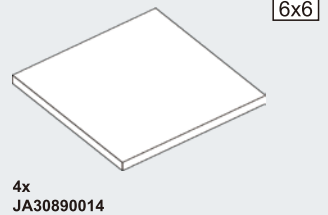
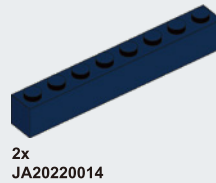
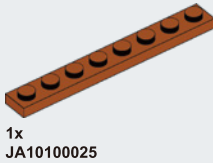
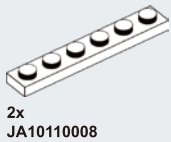
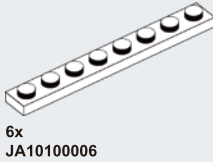
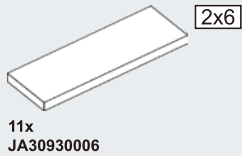
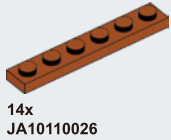
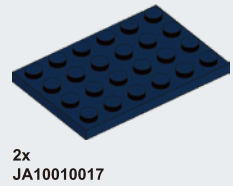
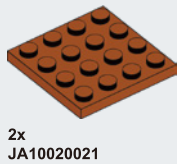
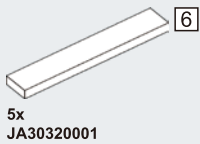



10

5x  
JA30380005

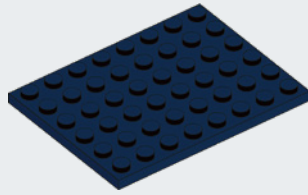

2x  
JA10520013

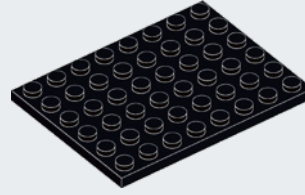

1x  
JA10520012



10

2x  
JA30380010

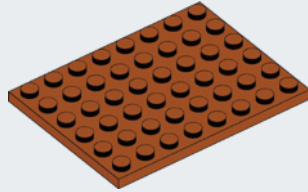

2x  
JA10520011

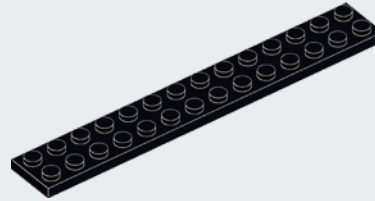

7x  
JA10830007

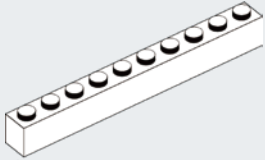

1x  
JA20800001

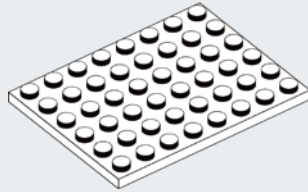

3x  
JA10520003

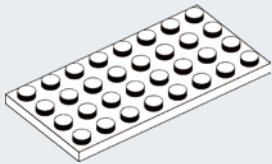

2x  
JA10420001

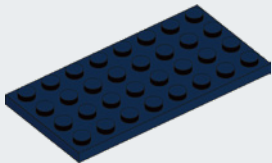

1x  
JA10420018

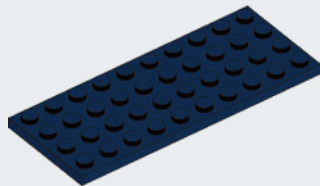

2x  
JA10510007

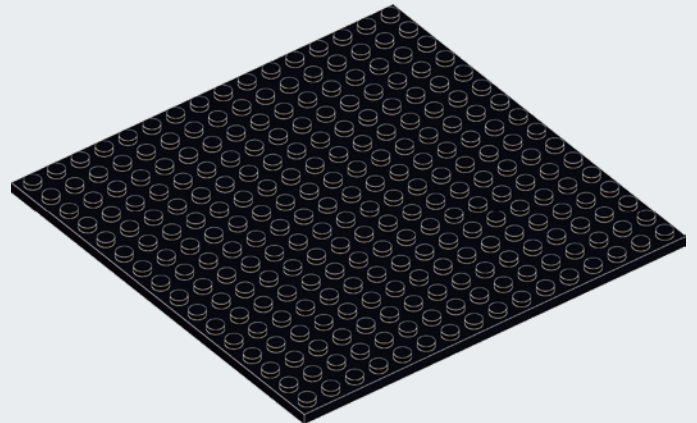

2x  
JA10750007

CaDA®



CaDA®

 [www.doubleeagle-group.com](http://www.doubleeagle-group.com)

C66002



403ARC660160001

C66010



Harvard Business School

C66016